



stainless

DOMESTIC SINK RANGE

Style and Functionality All-In-One



CLASSIQUE DESIGNER



CLASSIQUE PLUS



CLASSIQUE

INDEX

CLASSIQUE RANGE	1
Sparta Series	2
Kiba Series	3
Laundry Series	4/5
CLASSIQUE PLUS RANGE	6
Athena Series	7
Amaltia Series	8
Hercules Series	9
CLASSIQUE DESIGNER RANGE	10
Crystalon Series	11
Olynthos Series	12
Lydia Series	13
Iris Series	14
OCTI PLUMBING KIT	15
STAINLESS STEEL CLEANING CRÈME	15

CLASSIQUE RANGE

Sinks for the Discerning Home Owner



SPARTA SERIES

Reversible Drop In Sinks

FEATURES: Austenitic Stainless Steel, Recessed Drainage Ledge, Folded Edges for Added Strength, 90mm Waste Fitting.

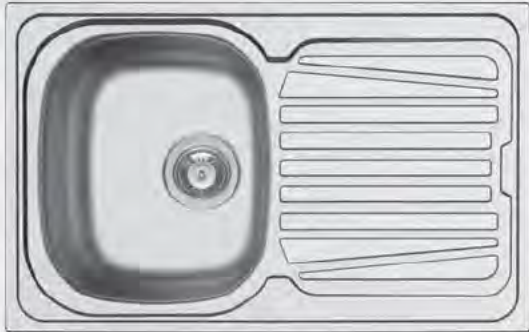

PRODUCT CODE: SDI-790-SE

CONFIGURATION: Single End Bowl
SINK DIMENSIONS: 790mm x 500mm
BOWL DIMENSIONS: 340mm x 400mm
BOWL DEPTH: 150mm
MINIMUM CUPBOARD DIMENSION: 450mm

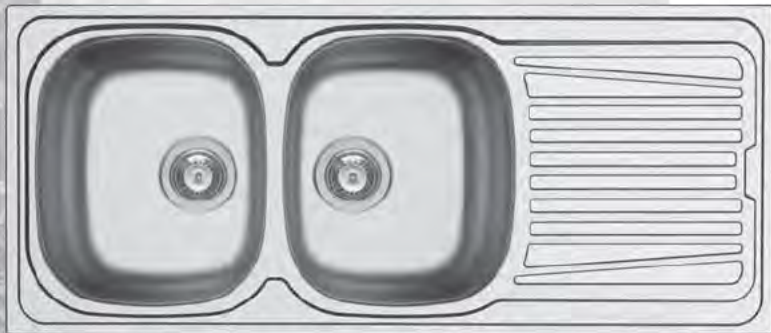
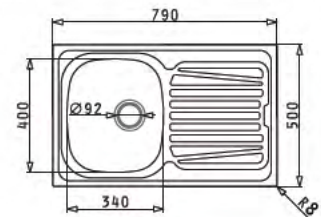

PRODUCT CODE: SDI-1160-DE

CONFIGURATION: Double End Bowls
SINK DIMENSIONS: 1160mm x 500mm
BOWL DIMENSIONS: 340mm x 400mm
BOWL DEPTH: 150mm
MINIMUM CUPBOARD DIMENSION: 800mm

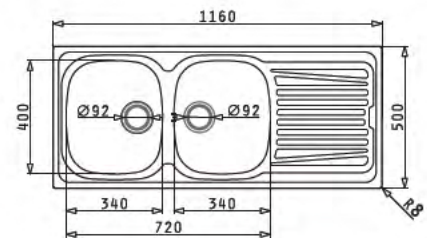

PRODUCT CODE: SDI-1380-DC

CONFIGURATION: Double Centre Bowls
SINK DIMENSIONS: 1380mm x 480mm
BOWL DIMENSIONS: 330mm x 395mm
BOWL DEPTH: 170mm
MINIMUM CUPBOARD DIMENSION: 800mm

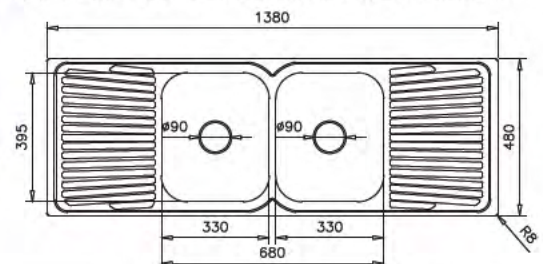

KIBA SERIES

Drop In Preparation Bowls

FEATURES: Austenitic Stainless Steel, 90mm Waste Fitting.



PRODUCT CODE:

SPB-STDP

CONFIGURATION: Single Bowl

OUTER DIMENSIONS: Ø450mm

BOWL DIMENSIONS: Ø385mm

BOWL DEPTH: 150mm

MINIMUM CUPBOARD DIMENSION: 450mm

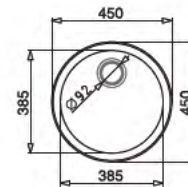

PRODUCT CODE:

SPB-THP

CONFIGURATION: Single Bowl with Tap Landing

OUTER DIMENSIONS: Ø485mm

BOWL DIMENSIONS: Ø385mm

BOWL DEPTH: 163mm

MINIMUM CUPBOARD DIMENSION: 450mm

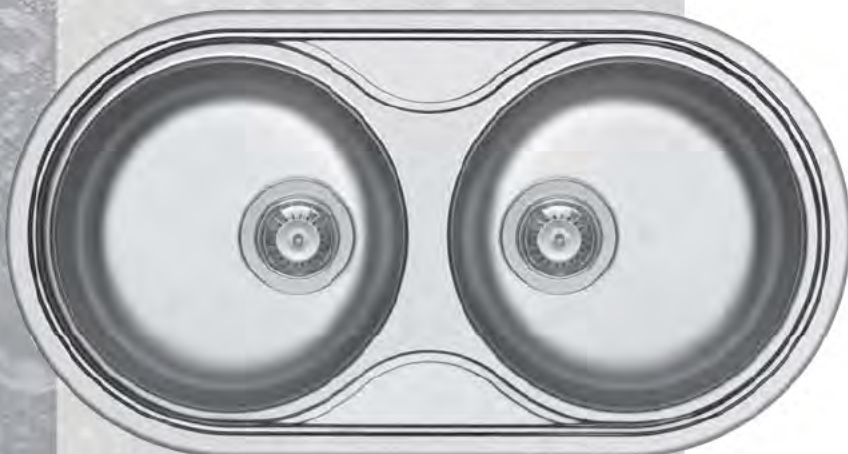

PRODUCT CODE:

SDI-850-DBR

CONFIGURATION: Double Bowls

OUTER DIMENSIONS: 850mm x 450mm

BOWL DIMENSIONS: Ø360mm

BOWL DEPTH: 160mm

MINIMUM CUPBOARD DIMENSION: 800mm

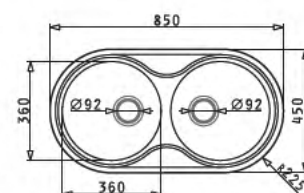

LAUNDRY SERIES

Drop In Washtroughs

FEATURES: Austenitic Stainless Steel, 90mm Waste Fitting.



PRODUCT CODE:

SWT-RIBP

CONFIGURATION: Single Trough with Rib
OUTER DIMENSIONS: 550mm x 450mm
TROUGH DIMENSIONS: 400mm x 500mm
TROUGH DEPTH: 230mm
MINIMUM CUPBOARD DIMENSION: 600mm

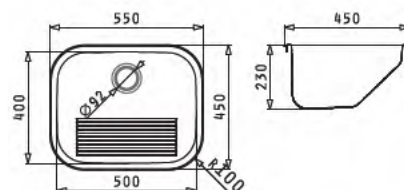

PRODUCT CODE:

SWT-SPACE

CONFIGURATION: Single Trough
OUTER DIMENSIONS: 610mm x 480mm
TROUGH DIMENSIONS: 500mm x 400mm
TROUGH DEPTH: 200mm
MINIMUM CUPBOARD DIMENSION: 550mm

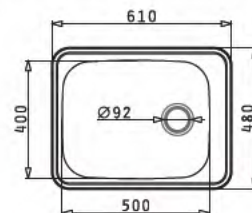

PRODUCT CODE:

SWT-AUSR

CONFIGURATION: Single Trough
OUTER DIMENSIONS: 635mm x 500mm
TROUGH DIMENSIONS: 535mm x 403mm
TROUGH DEPTH: 230mm
MINIMUM CUPBOARD DIMENSION: 600mm

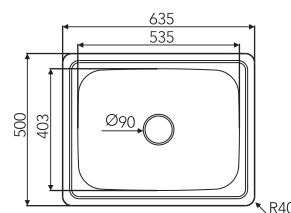

LAUNDRY SERIES

Wall Mounted Washtrough

FEATURES: Austenitic Stainless Steel.

90mm Waste Fitting, Wall Brackets.



PRODUCT CODE:

SWT-WM

CONFIGURATION: Single Trough with Rib

OUTER DIMENSIONS: 550mm x 450mm

TROUGH DIMENSIONS: 400mm x 500mm

TROUGH DEPTH: 230mm

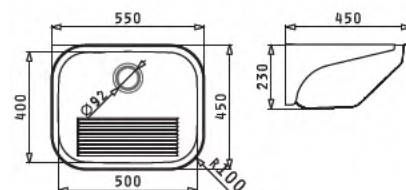

Sit On Washtrough

40mm Waste Fitting, Brackets optional for Wall Mounting



PRODUCT CODE:

SWT-SON

CONFIGURATION: Single Trough

OUTER DIMENSIONS: 600mm x 500mm

TROUGH DIMENSIONS: 520mm x 415mm

TROUGH DEPTH: 230mm

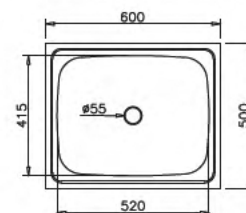

CLASSIQUE PLUS RANGE

Sinks for the Deserving Home Owner



ATHENA SERIES

Reversible Drop In Sinks

FEATURES: Austenitic Stainless Steel, Recessed Draining Ledge, Folded Edges for Added Strength, 90mm Waste Fitting.



PRODUCT CODE: SDI-790-SEA

CONFIGURATION: Single End Bowl
 SINK DIMENSIONS: 790mm x 500mm
 BOWL DIMENSIONS: 340mm x 400mm
 BOWL DEPTH: 180mm
 MINIMUM CUPBOARD DIMENSION: 450mm

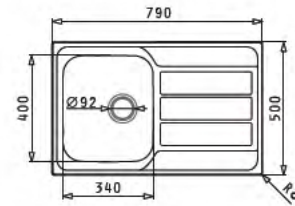

PRODUCT CODE: SDI-1160-DEA

CONFIGURATION: Double End Bowls
 SINK DIMENSIONS: 1160mm x 500mm
 BOWL DIMENSIONS: 340mm x 400mm
 BOWL DEPTH: 165mm
 MINIMUM CUPBOARD DIMENSION: 800mm

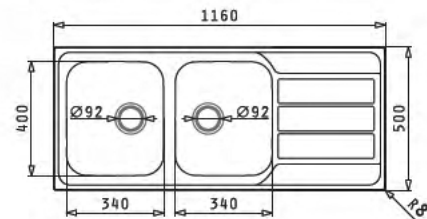

PRODUCT CODE: SDI-1350-DE

CONFIGURATION: Double End Bowls with Tidy Bowl
 SINK DIMENSIONS: 1350mm x 480mm
 BOWL DIMENSIONS: 340mm x 400mm
 TIDY BOWL DIMENSIONS: 165mm x 290mm
 BOWL DEPTH: 150mm and 120mm
 MINIMUM CUPBOARD DIMENSION: 900mm

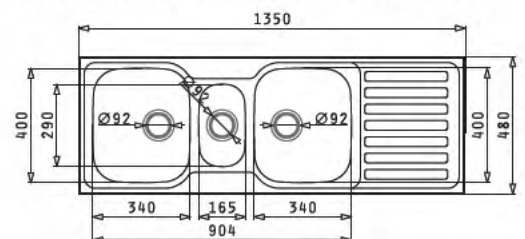

AMALTIA SERIES

Drop In Sinks

FEATURES: Austenitic Stainless Steel, Recessed Draining Ledge
Folded Edges for Added Strength, 90mm Waste Fitting.



PRODUCT CODE:

SDI-116-DLHB
SDI-116-DRHB

CONFIGURATION: Double End Bowls

SINK DIMENSIONS: 1160mm x 500mm

BOWL DIMENSIONS: 450mm x 400mm

and 300mm x 340mm

BOWL DEPTHS: 200mm and 170mm

MINIMUM CUPBOARD DIMENSION: 900mm

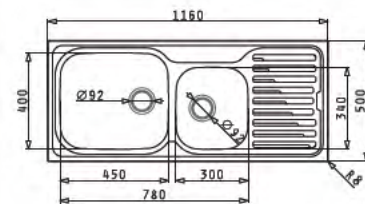

CELESTE SERIES

Drop In Corner Sinks

FEATURES: Austenitic Stainless Steel, Recessed Draining Ledge
Folded Edges for Added Strength, 90mm Waste Fitting.



PRODUCT CODE:

SDI-CORN-LH
SDI-CORN-RH

CONFIGURATION: Double End Bowls

SINK DIMENSIONS: 830mm x 830mm

BOWL DIMENSIONS: 340mm x 390mm

and 330 x 330mm

BOWL DEPTHS: 210mm and 215mm

MINIMUM CUPBOARD DIMENSION: 800mm

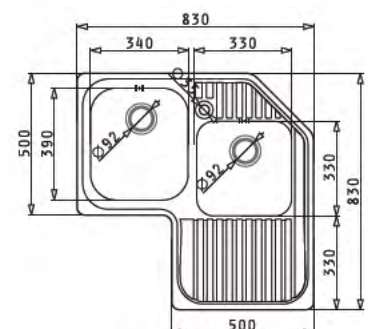

HERCULES SERIES

Reversible Drop In Sinks

FEATURES: Austenitic Stainless Steel, Recessed Draining Ledge
Folded Edges for Added Strength, 90mm Waste Fitting.



PRODUCT CODE: SDI-1450-DE

CONFIGURATION: Double End Bowls
SINK DIMENSIONS: 1450mm x 500mm
BOWL DIMENSIONS: 430mm x 400mm
BOWL DEPTH: 200mm
MINIMUM CUPBOARD DIMENSION: 1000mm

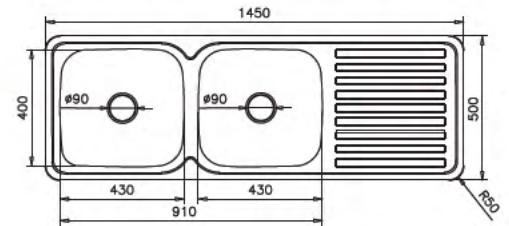

PRODUCT CODE: SDI-1500-DC

CONFIGURATION: Double Centre Bowls
SINK DIMENSIONS: 1500mm x 500mm
BOWL DIMENSIONS: 350mm x 410mm
BOWL DEPTH: 170mm
MINIMUM CUPBOARD DIMENSION: 800mm

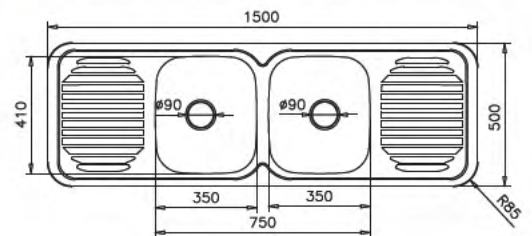

CLASSIQUE DESIGNER RANGE

Sinks for the Distinguished Home Owner



CRYSTALON SERIES

Reversible Drop In Sinks

FEATURES: Tempered Glass Surface, Austenitic Stainless Steel, Satin Finish Bowls, Large Deep Bowls, 90mm Waste Fitting.



PRODUCT CODE: SDI-860-SBGB

CONFIGURATION: Single End Bowls
SINK DIMENSIONS: 860mm x 500mm
BOWL DIMENSIONS: 340mm x 400mm
BOWL DEPTH: 200mm
MINIMUM CUPBOARD DIMENSION: 500mm

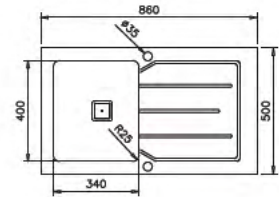

PRODUCT CODE: SDI-860-SBGW

CONFIGURATION: Single End Bowl
SINK DIMENSIONS: 860mm x 500mm
BOWL DIMENSIONS: 340mm x 400mm
BOWL DEPTH: 200mm
MINIMUM CUPBOARD DIMENSION: 500mm



PRODUCT CODE: SDI-1160-DBGB

CONFIGURATION: Double End Bowls
SINK DIMENSIONS: 1160mm x 500mm
BOWL DIMENSIONS: 340mm x 400mm
BOWL DEPTH: 200mm
MINIMUM CUPBOARD DIMENSION: 800mm

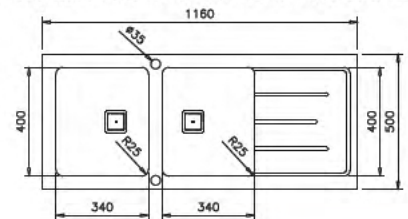

PRODUCT CODE: SDI-1160-DBGW

CONFIGURATION: Reversible Double End Bowls
SINK DIMENSIONS: 1160mm x 500mm
BOWL DIMENSIONS: 340mm x 400mm
BOWL DEPTH: 200mm
MINIMUM CUPBOARD DIMENSION: 800mm

OLYNTHOS SERIES

Fabricated Flushmount Sinks

FEATURES: Austenitic Stainless Steel, Brushed Finish, Hygienic 25 Degrees Radius Corners on Bowls, 90mm Waste Fitting.



PRODUCT CODE:

SDI-1000-SFL
SDI-1000-SFR

CONFIGURATION: Single End Bowl

SINK DIMENSIONS: 1000mm x 520mm

BOWL DIMENSIONS: 450mm x 400mm

BOWL DEPTH: 200mm

MINIMUM CUPBOARD DIMENSION: 600mm

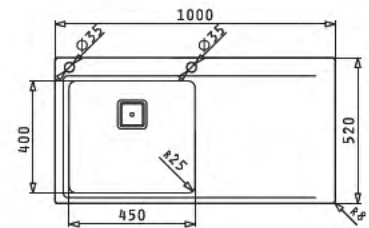

PRODUCT CODE:

SDI-1160-DFPL
SDI-1160-DFPR

CONFIGURATION: Double End Bowls

SINK DIMENSIONS: 1160mm x 520mm

BOWL DIMENSIONS: 340mm x 400mm

BOWL DEPTH: 200mm

MINIMUM CUPBOARD DIMENSION: 800mm

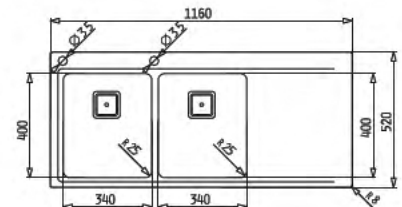

LYDIA SERIES

Undermount Sinks

FEATURES: Austenitic Stainless Steel, Brushed Finish, Hygienic 25 Degree Radius Corners on Bowls, 90mm Waste Fitting.



PRODUCT CODE: SDI-400-SUM

CONFIGURATION: Single Bowl Undermount
SINK DIMENSIONS: 440mm x 440mm
BOWL DIMENSIONS: 400mm x 400mm
BOWL DEPTH: 200mm
MINIMUM CUPBOARD DIMENSION: 450mm

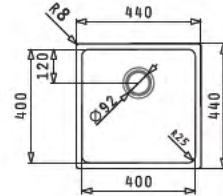

PRODUCT CODE: SDI-450-SUML

CONFIGURATION: Single Bowl Undermount
SINK DIMENSIONS: 490mm x 440mm
BOWL DIMENSIONS: 450mm x 400mm
BOWL DEPTH: 200mm
MINIMUM CUPBOARD DIMENSION: 500mm

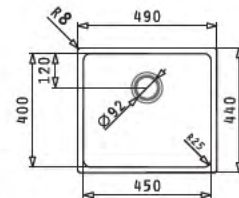

PRODUCT CODE: SDI-776-DUM

CONFIGURATION: Double Bowl Undermount
SINK DIMENSIONS: 766mm x 456mm
BOWL DIMENSIONS: 340mm x 400mm
BOWL DEPTH: 200mm
MINIMUM CUPBOARD DIMENSION: 800mm

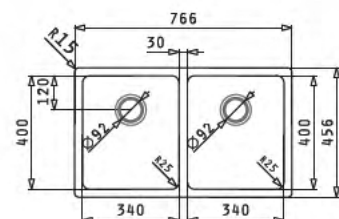

IRIS SERIES

Undermount Sinks

FEATURES: Austenitic Stainless Steel, Satin Finish,
90mm Waste Fitting.



PRODUCT CODE: SDI-290-SUM

CONFIGURATION: Single Tidy Bowl Undermount
SINK DIMENSIONS: 304mm x 180mm
BOWL DIMENSIONS: 288mm x 165mm
BOWL DEPTH: 120mm
MINIMUM CUPBOARD DIMENSION: 300mm

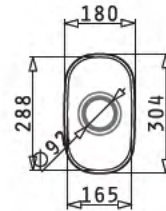

PRODUCT CODE: SDI-450-SUM

CONFIGURATION: Single Bowl Undermount
SINK DIMENSIONS: 472mm x 422mm
BOWL DIMENSIONS: 450mm x 400mm
BOWL DEPTH: 200mm
MINIMUM CUPBOARD DIMENSION: 500mm

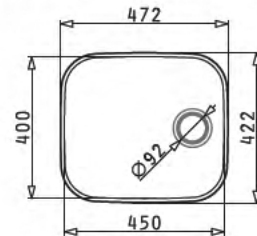

PRODUCT CODE: SDI-770-DUM

CONFIGURATION: Double Bowl Undermount
SINK DIMENSIONS: 766mm x 456mm
BOWL DIMENSIONS: 340mm x 400mm
BOWL DEPTH: 180mm
MINIMUM CUPBOARD DIMENSION: 800mm

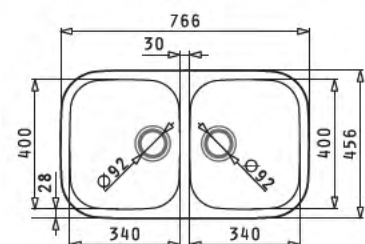



OCTI

plumbing kit



SSKIT-OCTI-1



SSKIT-OCTI-2



SSKIT-OCTI-3

SPACE SAVING WASTE KITS

PRODUCT FEATURES:

- Interlocking PVC pipes for 40mm and 90mm waste outlets
- Space saving
- Easy to install
- Can be used on all sinks

PRODUCT CODE	WASTE OUTLET
SSKIT-OCTI-1	Single Bowl
SSKIT-OCTI-2	Double Bowl
SSKIT-OCTI-3	Triple Bowl



stainless



SS-CLEAN

STAINLESS STEEL CLEANING CRÈME

PRODUCT FEATURES:

- Gentle yet effective for cleaning kitchen sinks, prep bowls, washtroughs and other stainless steel products ie cutlery, bread tins, mixing bowls and canisters.
- Available in a 250ml tub.

Electrolux SA (Pty) Ltd

Inland

3 Aberdeen Road,
Industrial Sites,
Benoni

Tel: (011) 897 4600

Email:
Sales.Inland@electrolux.com
Sales.Export@electrolux.com

Eastern Cape

39-41 Leadwood Crescent,
Fairview,
Port Elizabeth

Tel: (041) 399 4000

Email:
Sales.Easterncape@electrolux.com

Western Cape

15 Purdey Road,
Sheffield Business Park, Phillippi,
Cape Town

Tel: (021) 690 2700

Email:
Sales.Westerncape@electrolux.com

Kwazulu-Natal

814 Peter Close,
Springfield Park,
Durban

Tel: (031) 574 8700

Email:
Sales.Kwazulunatal@electrolux.com

Support

Email:
Kwikot,MarketingInfo@electrolux.com