

Commercial Series

Air Source Heat Pump Water Heater

Instruction Manual

Model: GT-SKR030P
GT-SKR050P
GT-SKR070P
GT-SKR100P
GT-SKR150P
GT-SKR030B (commercial unit)
GT-SKR050B

- ◆ The instructions in this manual are for the use of qualified individuals specially trained and experienced in the installation and maintenance of this type of equipment.
- ◆ Persons not qualified shall not attempt to install, service, or maintain this equipment.
- ◆ Please read the manual carefully before installation.
- ◆ Please keep this manual well for future reference.

TABLE OF CONTENTS

Part I: General Information	3
Part II: Application & Installation	6
Installation Location requirement.....	6
Installation illustration.....	7
How to open the front panel.....	8
Install the unit.....	8
Electrical connection.....	9
How to relocate the control panel.....	10
Trial operation.....	11
Part III: Control System	13
Lock/Unlock the buttons.....	13
On/Off the unit.....	13
Set the clock.....	14
Set water tank temperature	14
Set/Review/Cancel the timer of On/Off.....	14
Set//Review/Cancel the timer of water supply.....	14
Manually control water supply.....	15
Set the parameters.....	15
Data review	15
Part IV: Maintenance	17
Part V: Trouble shooting	18
Part VI: Wiring diagram	20

Part I: General Information

1.1 Function description

Air source heat pump water heaters are used to make hot water for space heating, domestic hot water systems or commercial hot water systems.

1.2 Important Information



For your own security, and to ensure proper operation of the unit, this heat pump unit must be installed and repaired by qualified technician, not consumer himself.



A leakage protection switch must be installed near the heat pump in an accessible place.



Do not use any damaged wires and switches, If found (to be damaged), replace it immediately.



Do not open the electrical box without shutting off all power sources to the heat pump.



When transporting the heat pump, ensure that it is not upside down and not tilted more than 45° in any direction.



Before performing any maintenance on the heat pump you must switch it off first and shut off the power to the unit.



This unit is designed for outdoor installation, do not install it in an enclosed area.



Do not install the unit in places where there are any inflammable or explosive materials.



Do not restrict or block the area around the air intake or outlet.



When the unit is not used for a long time, please switch it off and disconnect the power supply. Drain the unit when ambient temperature is lower than 0°C.



When power failure occurs and lasts for more than 3-5 hours with the ambient temperature $\leq 2^{\circ}\text{C}$, please drain water to prevent the formulation of ice in the unit.



This appliance is not intended for use by persons (including children) with reduced physical, sensory or mental capabilities, or lack of experience or knowledge, unless they have been given supervision or instruction concerning use of the appliance by a person responsible for their safety.



Respect safety distance between the unit and other equipment or structures. Guarantee adequate space for access to the unit for maintenance and/or service operations.



Power supply: the cross section of the electrical cables must be adequate for the power of the unit

and the power supply voltage must correspond with the value indicated on the respective units. All units must be earthed in conformity with legislation in force in the country concerned.

1.3 About heat pump

Heat pumps are effective solutions to heating and cooling applications for all types of buildings, domestic, commercial and retail premises including hotels and residential complexes.

This well-proven technology has been in use for decades and Heat Pumps are at work all over the world providing safe, reliable heating and cooling at affordable prices.

Reserves of conventional fossil fuels are finite and emissions of Carbon Dioxide and other greenhouse gases add increasingly to the effects of climate change. As a low carbon technology, heat pumps can significantly reduce the Carbon Dioxide emissions.

Where Heat Pumps are used for heating, they are capable of highly cost-efficient energy applications because they tap into a limitless supply of clean, pollution-free heat – either the surrounding air or heat captured in the ground – all you pay for is the energy to transport that heat, so the fact is heat pumps supply more energy than they consume.

1.4 Working principle

The basic principle of how a air source heat pump works is simple. It works just like air conditioner in cooling mode, however, in heating mode, the refrigerant flow is reversed and heat is extracted from the outside air to heat air or water. So the purpose of a heat pump is to absorb heat in one place where it is plentiful, then to transport and release it in another location where it can be used for space or water heating.

In order to absorb and release the heat into and from the refrigerant, we exploit the ability of the refrigerant fluid to boil from a liquid to a vapor and then to condense back into a liquid. This is a continual process while the compressor is running and circulating the refrigerant.

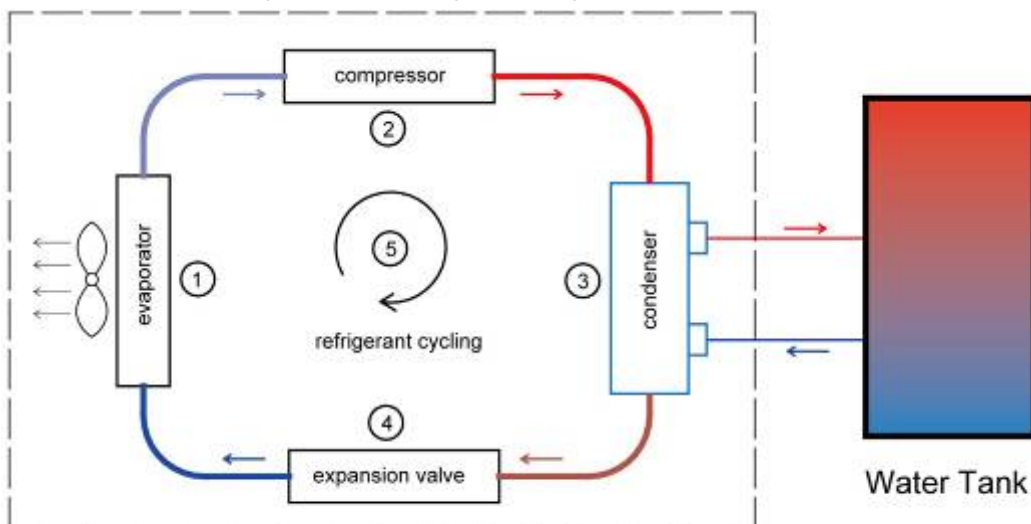

Air Source Heat Pump Water Heater

1. The refrigerant in system extracts free heat energy from outside air through fin-coil evaporator.
2. The refrigerant is compressed to a high-temp. & high-pressure gas by compressor.
3. Heat energy transferred to water through tube-in-shell heat exchanger.
4. The refrigerant in system restores to low-energy condition
5. The cycle is repeated.

1.5 Features of heat pump water heater

1) Wide application

It can be widely used in villas, factories, schools, hospitals, hotels, restaurant, swimming pools and spas, bath centers, laundries, etc.

2) More Safety

Water and electricity are completely isolated, No electric shock problem, more secure than traditional electrical water heaters.

No fuel tubes and storage, no potential danger from oil leakage, fire, explosion, etc.

a full range of protection including compressor delay protection, dual pressure protection, overheating protection, Anti-phase and open-phase protection, high temperature protection, etc.

3) Energy-saving

Provide the same amount of hot water at 1/4 cost of electrical water heaters, heat pump water heater unit can save your bill every day.

4) Super-Sized evaporator coil

It adopts hydrophilic aluminum fin and rifled copper pipe.

5) High efficiency heat exchanger

It adopts high efficiency tube-in-shell heat exchanger.

6) World famous Compressor

It adopts the world famous brand compressor---“Copeland”, “Panasonic”, “Sanyo”, “Toshiba”, unmatched reliability, quiet operation, energy-saving and environmental-friendly.

7) Monoblock design, convenient installation, nice appearance.

8) All-weather running

Reliable hot water offer no matter in a rainy day, snowy day or at night.

9) Running automatically

Micro-computer controlled, with timer function, it can automatically start up and stop according to the water temperature and other running conditions you set, no need for a supervisor.

10) Environmental friendly

Environment-friendly, free of pollutions, it reduces the global green house effect.

Part II Installation & Application

2.1 Transportation



When transporting the heat pump, ensure that it is not tilted more than 45° in any direction.

The unit in its case can be transported with a lift truck or hand truck.

2.2 Accessories

Remove the packaging, be careful not to damage any components.

No	Item	Quantity
1	Instruction Manual	1
2	Condensate connector	1
3	Shockproof rubber pads	1 set

2.3 Installation Location Requirement



This unit is designed for outdoor installation, please do not install it in an enclosed area.

It is very important to select a proper position for the unit, please consider the followings:

- Choose a horizontal position where it can stand the weight of the unit, and it won't increase noise and vibration as well, preferably on a concrete slab. And the supporting base must be high enough to keep unit completely free of standing water at all times.
- Do not install the unit within 1000mm of fossil fuel burning heaters. Air intakes along the sides of the heat pump unit could disturb the combustion process of the unit and cause damage or personal injury.
- Choose the place with good ventilation and not close. The minimum distance between the wall (or other objects) and the sides of the unit where the air comes in should not be less than 1000mm.(see figures below)
- Do not install the unit in place where there is pollution, corrosive gas, or accumulation of dirt or fallen leaves.
- There should not be inflammable or explosive materials close to the unit.
- Keep in mind that the heat pump will cause condensation, so the installation position should be close to drainage channel or vent to facilitate water discharge.

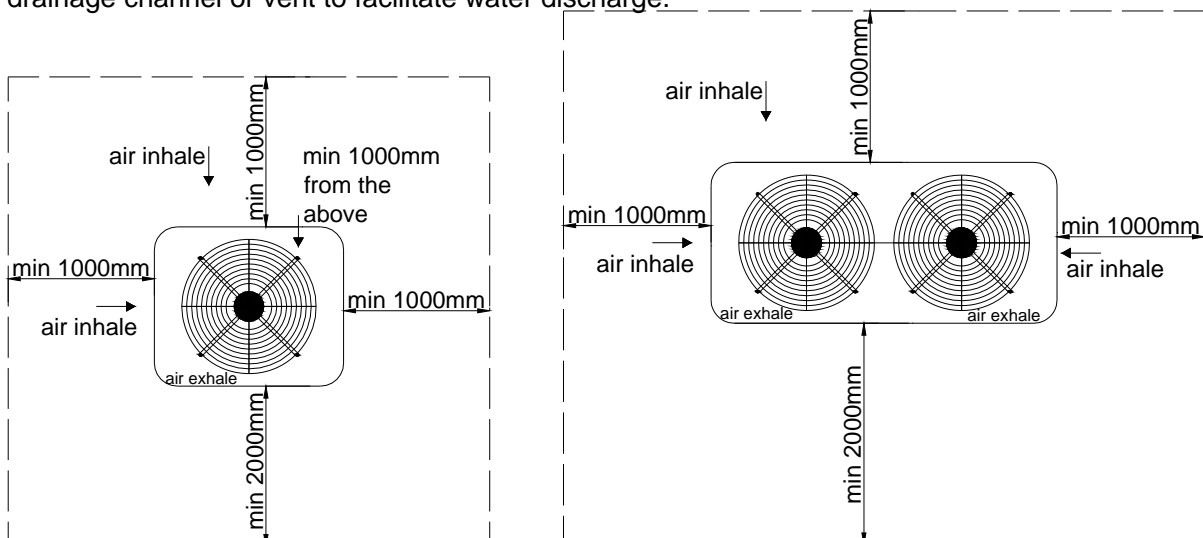

2.4 Installation

2.4.1 Installation Illustration for Heat Pump Water Heater (take vertical ventilation series for example)

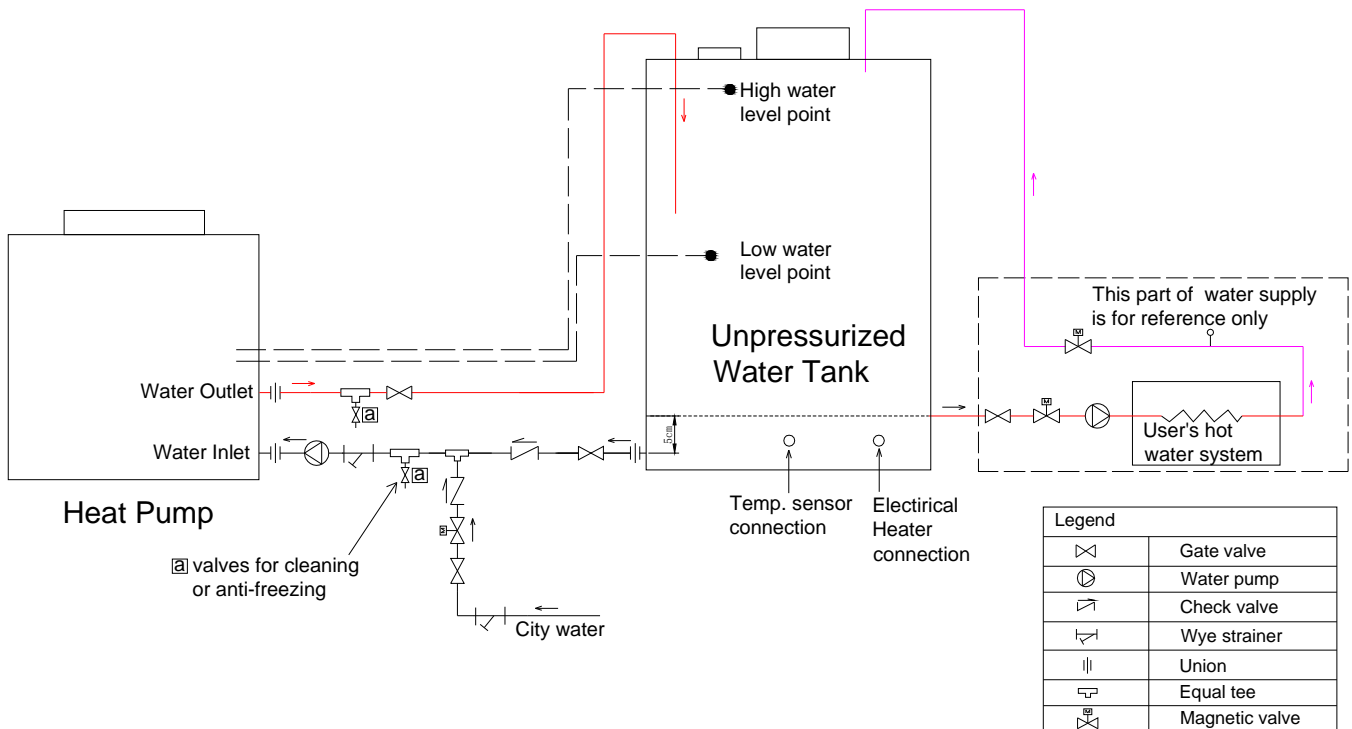

Note:

1. **"Water refill"**: add city water into water tank;
"Water supply": supply hot water from water tank to user;
"water return": when water temp. in pipes of user's system is lower than the temperature you set, water in pipes will return back to water tank through "water return magnetic valve", so water in the pipes is always hot. When there is no need for "water return" function, users do not need to install "water return magnetic valve" & "water return temp. sensor".
2. **"Water refill pump"**: When water pressure of city water is very low or not stable, it is suggested to install a "water refill pump". The power supply for "Water refill pump" and "Water refill magnetic valve" are synchronized.
3. **"Circulating pump"**: It is suggested to install extra AC contractor when the power of "circulating pump" and "water refill pump" are more than 500W respectively.
4. The hot water outlet of water tank which connects to user's hot water system must be higher than the water inlet of heat pump unit in order to avoid lack of water for the unit.
5. **Water level**: Users can adjust the high water level and low water level according to their actual needs.
6. **When water tank is pressurised type, there is no need to install magnetic valve and high/low water level switches.**

2.4.2 How to open the front panel

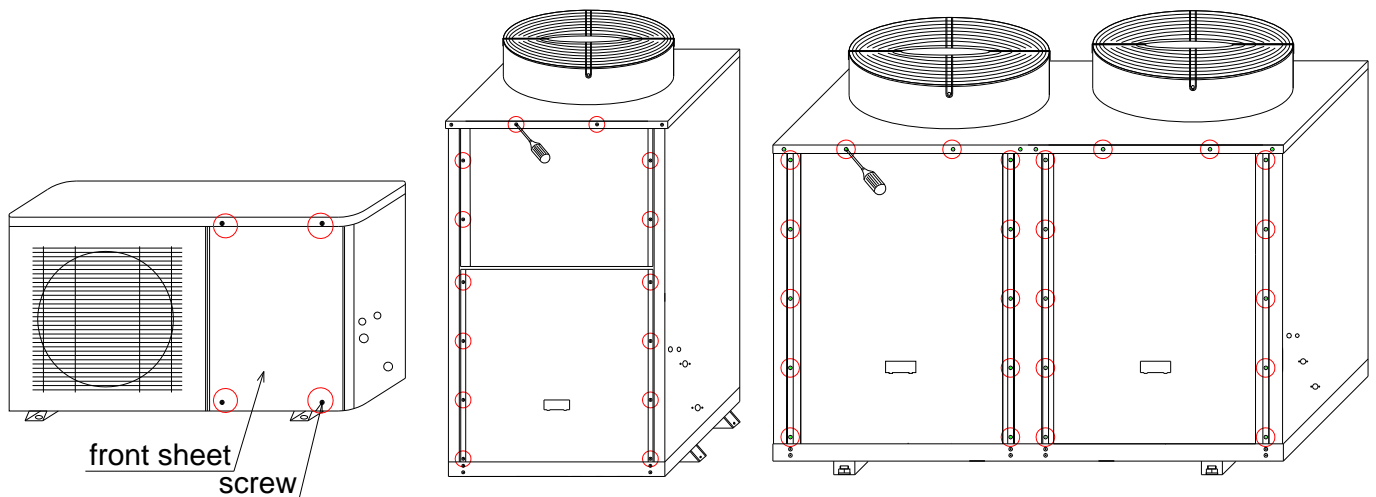

2.4.3 Install the unit (take vertical ventilation series for example)

- Choose a smooth, horizontal position according to the **Location Requirement**.
- The vertical distance between the unit and water tank must be less than 6m, and their horizontal distance should not be more than 20m. But the actual distance is determined by the capacity of circulating water pump.

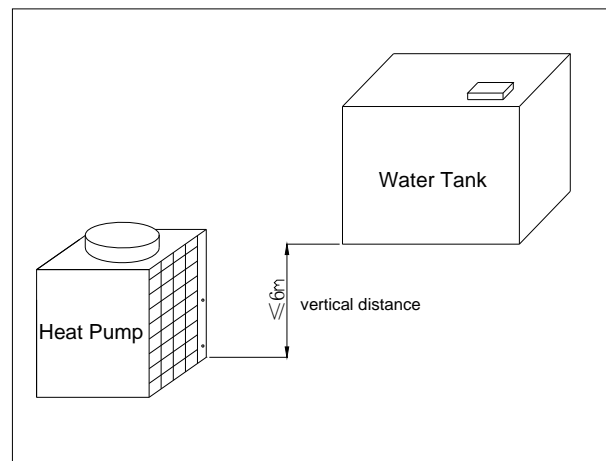
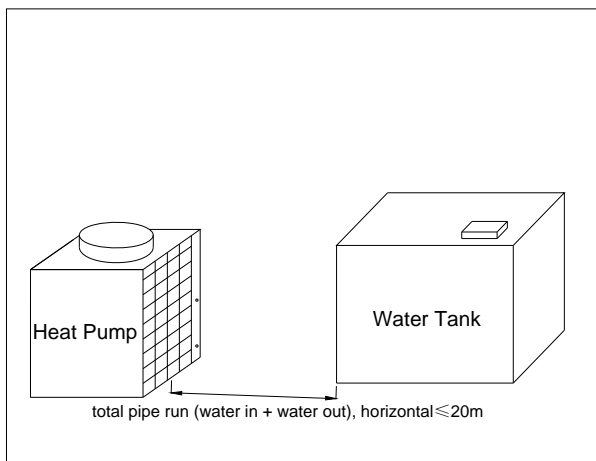

- Mount the unit on the selected base and install the 4 black rubber pads under the 4 corners of the unit to reduce vibration and sound transmission to the base. (see figure right)
- Fix the tank. If the tank is installed on the roof, you should install a lightning rod for fear of the lightning strike.
- Connect the water pipes between heat pump and tank according to **Installation Illustration**.
- Install the check valve as arrow shows.
- Make sure to Install Y strainer as shown on the **installation illustration** to prevent the circulating system from being clogged.

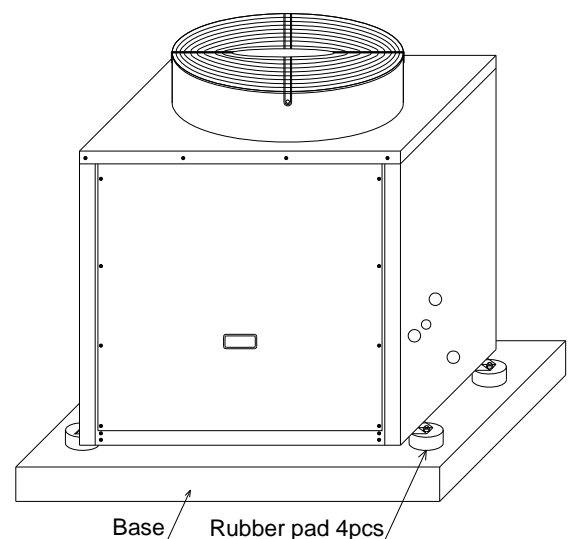

- h. Fix the tank temperature sensor well to prevent it from dropping down. Otherwise, it may cause an action of overheat protection or crash. **(See figure right and its Note)**
- i. Installation of condensate connector: Connect the connector at the bottom of the main unit. (See figure below)
- j. Install the water level switches of water tank, then connect the wire to “terminal block of control signal” (see wiring diagram). Or Users could control the water level by other means, such as ball float valve.

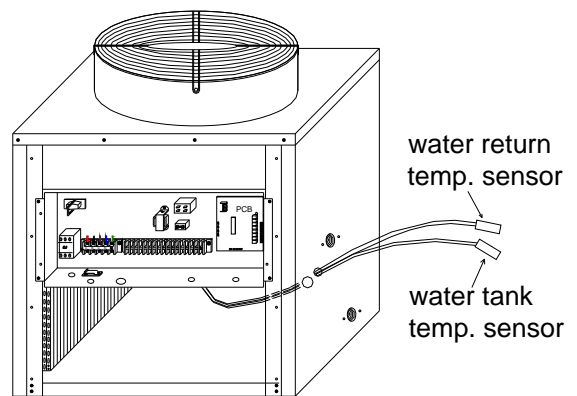

Note:

1. Do not put the probe directly into water.
2. Just leave the “water return temp. sensor” at there when users do not choose “water return” function.

2.4.3 Electrical Connection



- For your own security, and to ensure proper operation of the unit, this heat pump unit must be installed and repaired by qualified technician, not consumer himself.



- A leakage protection switch must be installed near the heat pump in an accessible place.



- Do not use any damaged wires and switches, If found (to be damaged), replace it immediately.



- Do not open the electrical box without shutting off all power sources to the heat pump.

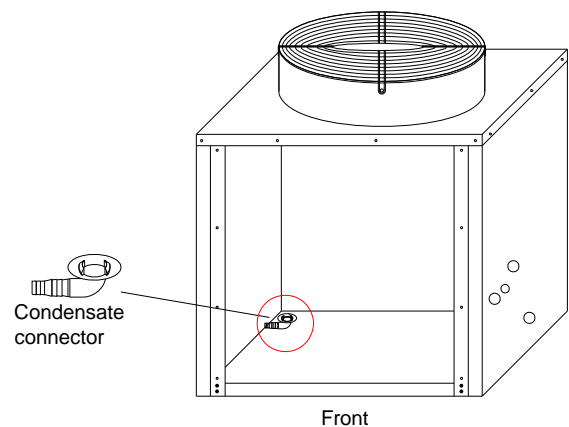
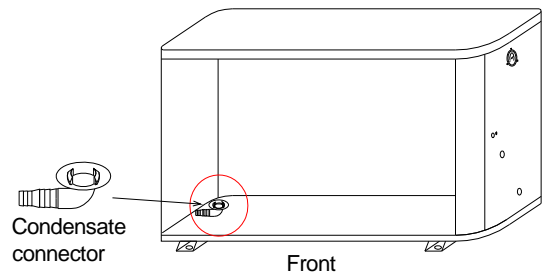

- All the wiring must meet the electrical safety requirement and conducted by qualified electricians.
- Ensure that there is a good earth connection for the power. Do not disconnect the earth connection of the power in any condition.
- Ensure that the heat pump water heater is well connected to the earth.
- Offer an separate power which meets rated requirements for the heat pump water heater
- When the water heater connects to the electricity network, there must be a short-circuit protection.
- Choose the suited type of wires when use the power outdoor.
- Do not use the main power switch to control the start/stop of the unit.
- After installation, double check before connect it to the power.

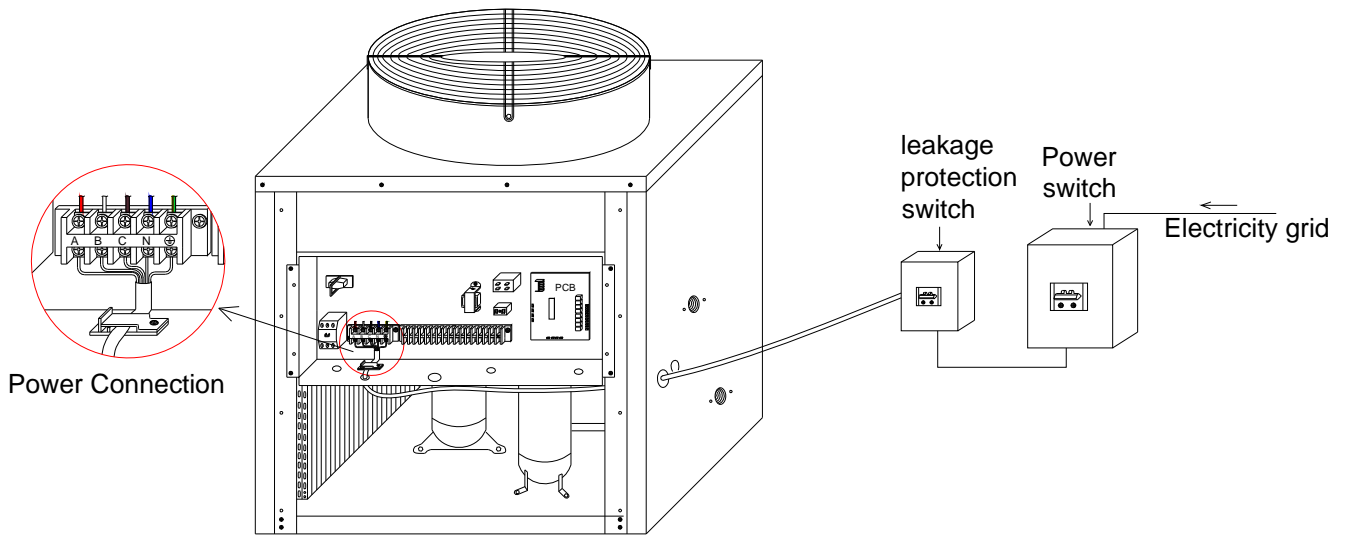

(Take Vertical Ventilation Series for Example)

2.4.5 How to relocate the control panel

open the control panel

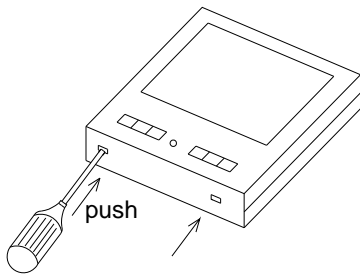

When you need to relocate the control panel, please refer to the following:

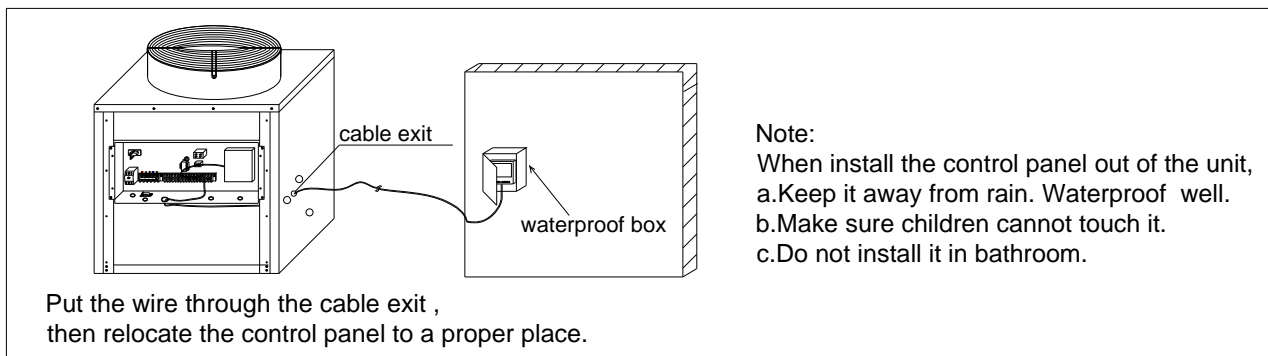

2.5 Trial Operation



To ensure that start-up is performed correctly, it should only be operated by qualified technician.

2.5.1 Preparation

The following items need to be checked prior to start-up:

- a). The heat pump must be fully connected.
- b). All valves that could impair the proper water flow in piping system must be open.
- c). The air intake and air outlet paths must be clear.
- d). Discharge the air in the suction pipe of the water pump.

For horizontal ventilation series, circulating water pump is installed inside the unit. It's essential to discharge air out of piping system as well as the water pump.

Open the gate valve to fill up the piping system and water tank, then discharge air in piping system and water tank (refer to the following instruction)

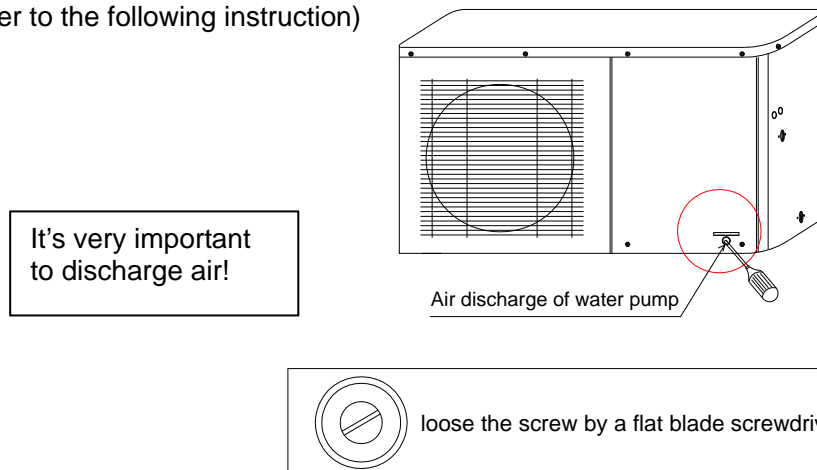

To discharge air in water pump and piping system:

- Step1: loosen the screw on the water pump through the hole,
- Step2: open water refilling gate valve to let the city water in,
- Step3: after the air is completely discharged, fasten the screw.

- e). Ensure the condensate outflow functions.
- f). The heat pump controller must be set in accordance with the controller's operating instructions. (Refer to **Part III Control System**)

2.5.2 Trial running

- The water outlet temperature is set by the controller. When the water temperature of the tank is higher than it is set, the unit will stop running, but if lower by 5°C (default temperature difference), it may restart automatically.
- Turn on the power, The heat pump is started up via the heat pump control panel. After the water pump have been running for 30 seconds, the unit starts to work, and then observe whether it works normally.
- When you restart the unit, the compressor won't start to work until **3 minutes** later, and this delay function is designed to protect the compressor.

2.5.3 Caution

If something happen as follows, please stop it immediately and cut the power off. You should contact with our authorized agent or maintenance personnel. Do not repair it by yourselves. Without professional technology, it may cause fire and you may get hurt.

- Fuse blown or protection device breaks frequently
- The wire and switches are heated singularly
- Abnormal sounds coming from the unit
- Abnormal smell comes out of the unit.
- Electricity leakage

Part III Control System

3.1 Overview

The controller consists of PCB and operation panel and it makes the unit more automatically for it can not only meet the internal control requirements, but also helps to control the external apparatus. Meanwhile, it can be easily set after it leaves the factory. And it becomes one kind of popular and advanced integrated controllers for its great integrated functions and its large screen operation panel.

3.2 Description of Icons

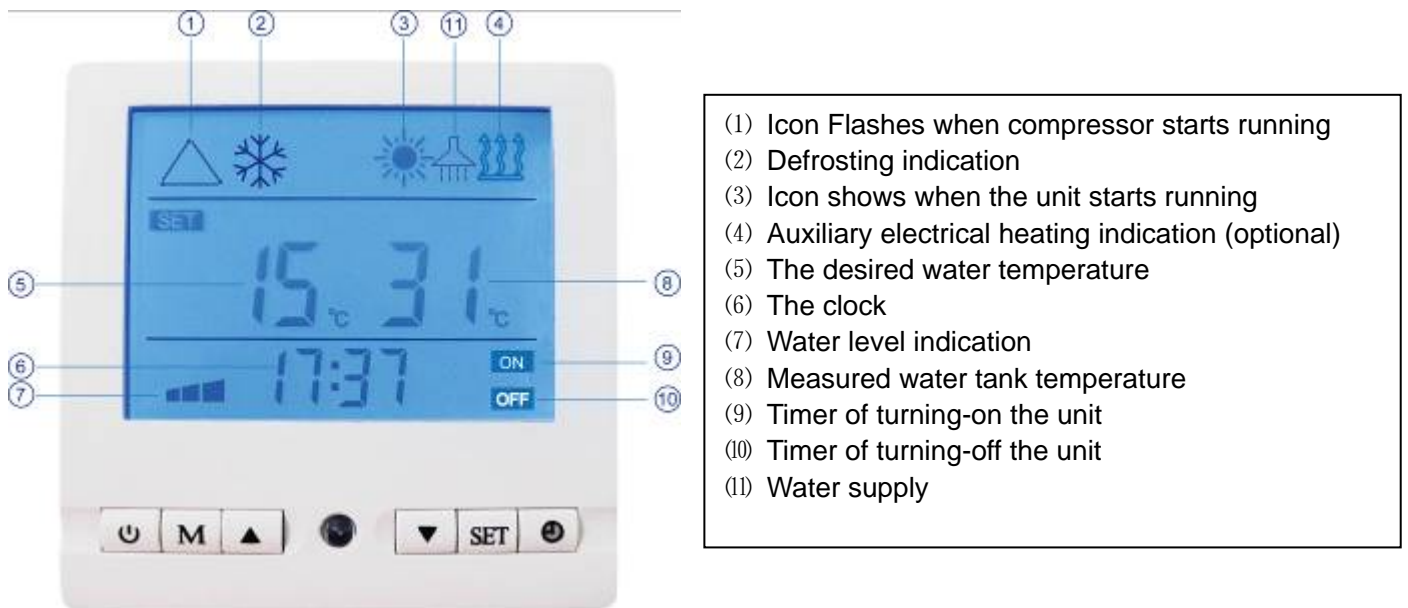

3.3 Operation Instruction



OFF



ON





Compressor starts running







A. Lock/Unlock the buttons

- Lock the buttons: Under ON or OFF status, extended press button simultaneously for 5 seconds, buttons are locked, and icon is shown on the screen.
- Unlock the buttons: Repeat the above step to unlock the buttons



B. On/Off the unit

1. Connect power to the unit, press  button to turn on the unit (see picture ON), When compressor starts working,  icon flashes on screen (see picture Compressor starts running)
2. When the unit is on, press  button, you can turn it off (see picture OFF).

C. Set the clock

Under ON or OFF status, extended press  button for 5 seconds, then press   button to set the hour, press  button, then press   button to set the minute, press  button to exit setting.

D. Set water tank temperature

When the unit is on, press   button to set desired water tank temperature. The setting will be saved automatically when no further operation on it for 10 seconds. The range is 28-60 degrees Cel.







Note:

- Heat pump unit will stop running automatically when water tank temperature reaches desired water temperature you set.















- The unit will start running automatically when water temperature drops to a certain temperature. (according to temperature difference you set, refer to item 05 in [table 3.1](#) below)

E. Set/Review/Cancel the timer of On/Off

Note:

You can set totally three periods of time for the unit to start/stop. Under ON or OFF status, Press  button once, “ 1  ” flashing on the screen; Press  button twice, “ 2  ” flashing on the screen; Press  button thrice, “ 3  ” flashing on the screen. And the cycle is repeated when you continue pressing  button.





1. Set timer: (Take “ 1  ” for example)

when “ 1  ” is flashing, Press  button, **ON** flashing on the screen, then press   button to set the hour, press  button, then press   button to set the minute, press  button, **OFF** flashing on the screen, then press   button to set the hour, press  button, then press   button to set the minute, press  button to finish setting. The setting will be saved automatically when no further operation on it for 10 seconds.

2. Cancel timer: To cancel timer, just set the unit to turning-on & turning-off at the similar time, then **ON** **OFF** icon disappeared.











F. Set//Review/Cancel the timer of “Water Supply”



Note:

You can set totally three periods of time for the unit to supply water automatically. Under ON or OFF status, extended press  button for 5 seconds to enter the interface,  icon flashes. “ 1 ” flashing on the screen; Press  button twice, “ 2 ” flashing on the screen; Press  button thrice, “ 3 ” flashing on the screen, and the cycle is repeated when you continue pressing  button.



1. Set timer: (Take “ 1 ” for example)

when “ 1 ” is flashing, Press  button, **ON** flashing on the screen, then press  

button to set the hour, press  button, then press   button to set the minute, press  button,  flashing on the screen, then press   button to set the hour, press  button, then press   button to set the minute, press  button to finish setting. The setting will be saved automatically when no further operation on it for 10 seconds.

2. Cancel timer: To cancel timer, just set the unit to turning-on & turning-off at the similar time, then   icon disappeared.

G. Manually control “Water Supply”

When water tank temp. reaches the temp. you set, Press  button, you can manually control water supply,  icon flashes on the screen.

H. Set the parameters (for technician only)













When the unit is on, extended press  button for 5 seconds to enter the interface. press  button, select item (01-08), press  button, then press   button to set, press  button to confirm. The setting will be saved automatically when no further operation on it for 10 seconds.

Table 3.1

Item	Description	Range	Default Value	Remark
01	Coil temp. to start defrosting	-1~-9℃	-3℃	 flashing
02	Coil temp. to stop defrosting	5~25℃	12℃	 flashing
03	Time interval for defrosting	10~90 Min	45 Min	 flashing
04	Running time of defrosting	5-17 Min	10 Min	 flashing
05	Temperature difference set	2-30	9	Refer to note 1,2,3 as below
06	Temp. compensation	0-30	0	
07	Water return temperature	28~60℃	40℃	 flashing, it's for commercial unit.
08	Ambient temp. for starting electrical heating	0~35℃	5℃	 flashing, when ambient temp. is lower than set temp. , electrical heating functions.

Note:

1. Set the temperature difference between the measured water temperature and desired water temperature
2. By setting the temperature difference users can control the unit to starts up/stops automatically.
3. For example, the default value is 9 (that represents 5℃), when the measured temperature is lower than desired water temperature by 5℃, the unit will start automatically. The unit will not stop until the measured temperature reaches the desired water temperature you set.
1 equals 0.5℃, the range is 2-30.

I. Data Review

When the unit is on, shortly press  button to enter the interface. press   button, review the

actual measured data as below, press  button to exit.

Table 3.2

Name	Item	Remark
Code of recoverable fault	01	It shows “28” when it works normally, others please refer to Table 3.3
“Mode Selection” Code Name	02	“00” timed water supply mode, “01” Direct water supply “02” Double tank water-supply mode (Apply to the double compressor system only)
Unit type	03	“00” 220V, 030P, No phase detection, single compressor “01” 380V, 030P/050P/070P, with phase detection, single compressor “10” 380V, 100P,150P with phase detection, double compressor
Coil 2 temperature	04	Monitoring point of Defrosting temp. for compressor 2 (for double system)
Coil 1 temperature	05	Monitoring point of Defrosting temp. for compressor 1
Ambient temperature	06	Opening measurement of the electric expansion valve, and the anti-freeze temperature
Water outlet temperature	07	overheating protection (70°C)
Water return temperature	08	Check the water temperature in the supply pipes and control the return water temperature
Water temperature in tank 1	09	temperature of water tank 1
Unused	10	Spare
Unused	11	Spare

Table 3.3 Recoverable faults

Fault Name	Remark
“01E” Overheat protection	Hydraulic pressure switch protection
“05E” Overheat protection	If the water outlet temperature is higher than 70°C and lasts for 20 seconds, the unit may stop. And when the temperature cools down, it will restart in three minutes.

3.4 Protection

- ◆ Compressor delay protection: the delay for the compressor to start/stop is three minute. The first time when it is power on, it starts up in one minute.
- ◆ High pressure protection: After compressor starts running and the high pressure switch interrupts for 10 seconds, the unit stops, “03E” flashing on the screen, and alarm sounds.
- ◆ Low pressure protection: After compressor starts running for 3 minutes and the low pressure switch interrupts for 10 seconds, the unit stops, “04E” flashing on the screen, and alarm sounds.
- ◆ When hydraulic pressure switch interrupts, the unit stops, “01E” fault code is shown on the screen and it won’t alarm. When the pressure recovers, the unit restarts automatically.
- ◆ Overheating protection: when water outlet temperature is higher than 70°C for 20 seconds, the compressor stops, and when the temperature cools down to where it is set and the unit meets the condition of stopping for three minutes, the unit restarts automatically,
- ◆ Sensor fault: if the sensor fault, all parts stop working (except the electric heating device)
- ◆ Anti-phase protection and Open-phase Protection: all the components are not allowed to work, and

fault code is shown on screen.

- ◆ Auto-antifreeze: To prevent the pipes and pumps from being frozen, the unit will defrost automatically when it meets the condition as follows: the ambient temperature is lower than 2°C and the water outlet temperature is lower than 10°C and the circulating pump has been power off for more than 30 minutes. The circulating pump start up for 60 seconds and then turn off. And this action is repeated periodically.
- ◆ Check the current when the unit starts up and if the current is stronger than the default current for 5 seconds the unit will shut down immediately and restart 3 minutes later. but if the same fault appears more than 3 times in an hour, the unit will alarm. The fault code is "02E".

Part IV Maintenance



Before performing any maintenance on the heat pump you must switch it off first and shut off the power to the unit.

A well-maintained heat pump could save your energy costs. When installed and tested by a qualified technician, heat pumps can deliver many years of dependable service and comfort. Below are some steps you can follow to ensure that your heat pump gives you optimum performance.

1. Turn the power off when the unit is being maintained.
2. Do not use petrol, naphtha, dissolvent and any other chemicals on the unit, otherwise, it may damage the surface. External heat pump parts can be wiped with a damp cloth and domestic cleaner.
3. Avoid leaning or putting objects on the device.
4. Keep it dry and drafty round the unit.
5. If the unit will be shut down for a long time, you should drain the water in the pipe, turn the power off and cover it with protective cover, Check it roundly before you start it again.
6. It is advised to use the phosphoric acid whose temperature is about 50~60°C and consistency is 15% to clean the heat exchanger of the unit. First start the circulating pump to clean it for 3 hours, and then flush it with tap water for three times. Do not use any amyctic detergent to clean the heat exchanger and the tank.
7. Change the installation site
If the customer wants to change the site, please contact with the dealer or the local Customer Service for help.

Part V Trouble shooting

Table 3

Fault Code	Fault	Possible Causes	Treatment
00E	Open-phase protection Anti-phase protection	◇Open-phase ◇Anti-phase	◇Check the three-phase power supply ◇Exchange wirings of two phases
01E	Hydraulic pressure switch protection	◇Hydraulic switch destroyed ◇Inadequate water-flow ◇There is air in the circulating water inlet tube ◇Circulating pump destroyed ◇Water tank lack of water	◇Replace the hydraulic switch ◇Clean Y strainer, increase the water flow rate ◇Discharge the air ◇Check and repair the pump and the capacitor ◇Ensure the tank is fully filled and the water pressure is over 0.15Mpa
02E	Current protection	◇Current excessive	◇Check the voltage and the power source
03E	High pressure switch 1 fault (protect when interrupts)	◇High pressure switch destroyed ◇Inadequate water-flow ◇The system is jammed, the probe of sensor falls down ◇circulating pump damaged ◇excessive refrigerant ◇some incondensable gas in the refrigerant system	◇Replace the high pressure switch ◇Increase the flow ◇Check and clean the system, retighten the probe ◇Check and repair the circulating pump and the capacitor ◇Drain out the superfluous refrigerant ◇Drain out the incondensable gas
04E	Low pressure switch 1 fault (protect when interrupts)	◇Low pressure switch destroyed ◇Inadequate refrigerant ◇The fins of the evaporator are dirty	◇Replace the low pressure switch ◇Leak hunting and fill in standard quantity of refrigerant ◇Clean the fins
05E	Overheating of the outlet water	◇Clogged water line ◇water outlet temperature sensor fault	◇Check the water system and the pump ◇Check the resistance of the sensor
06E	Water level switch destroyed (closes at high water level, interrupts at low water level)	◇Open/short circuit in the switch and wires	◇Check and renovate the switch and its wiring
07E	High pressure switch 2 fault (fault when interrupts)	◇High pressure switch destroyed ◇inadequate water-flow	◇Replace high pressure switch ◇Increase water-flow
08E	Low pressure switch 2 fault(fault when interrupts)	◇Low pressure switch destroyed ◇Inadequate refrigerant	◇Replace low pressure switch ◇Leak hunting and fill in standard quantity of refrigerant
09E	Communication error (the control panel can't receive information from the PCB)	◇Open circuit or short circuit between the operation panel and PCB	◇Renovate or Replace the wire between the control panel and the PCB
10E	Coil sensor 2 fault (open circuit or short circuit)	◇The sensor open circuit ◇The probe of the sensor falls down ◇the sensor short circuit	◇Reconnect the wirings of the sensor ◇Retighten the probe ◇Renovate wirings
11E	Coil sensor 1 fault (open circuit or short circuit)	◇The sensor open circuit ◇The probe of the sensor falls down ◇the sensor short circuit	◇Reconnect the wirings of the sensor ◇Retighten the probe ◇Renovate wirings
12E	Environment sensor fault (open circuit or short circuit)	◇The sensor open circuit ◇The probe of the sensor falls down ◇the sensor short circuit	◇Reconnect the wirings of the sensor ◇Retighten the probe ◇Renovate wirings

13E	Water outlet sensor fault (open circuit or short circuit)	<ul style="list-style-type: none"> ◇The sensor open circuit ◇The probe of the sensor falls down ◇the sensor short circuit 	<ul style="list-style-type: none"> ◇Reconnect the wirings of the sensor ◇Retighten the probe ◇Renovate wirings
14E	Water return sensor fault (open circuit or short circuit)	<ul style="list-style-type: none"> ◇The sensor open circuit ◇The probe of the sensor falls down ◇the sensor short circuit 	<ul style="list-style-type: none"> ◇Reconnect the wirings of the sensor ◇Retighten the probe ◇Renovate wirings
15E	Water-tank sensor 1 fault (open circuit or short circuit)	<ul style="list-style-type: none"> ◇The sensor open circuit ◇The probe of the sensor falls down ◇the sensor short circuit 	<ul style="list-style-type: none"> ◇Reconnect the wirings of the sensor ◇Retighten the probe ◇Renovate wirings

Note: when the fault arises, the correspondent fault code will be flashing on the screen and alarm sounds.

Table 4

Fault Condition	Possible Causes	Treatment
The unit doesn't work	<ul style="list-style-type: none"> ◇Power failure ◇Bad connection to the power ◇Fuse blow 	<ul style="list-style-type: none"> ◇Turn off the switch, check the Power source ◇Find the causes and renovate them ◇Replace the fuse
The pump is working but too noisy and the water is not cycled	<ul style="list-style-type: none"> ◇Lack water In the system ◇There is air in the water circulation ◇Any valve in the system is not open ◇Filter stoppage 	<ul style="list-style-type: none"> ◇Check the water refill device and refill water ◇Discharge the air ◇Open all the valves ◇Clean the filter
Low heating capacity	<ul style="list-style-type: none"> ◇Inadequate refrigerant ◇bad insulation of the water system ◇Drying filter stoppage ◇Air side heat exchanger is un-efficient ◇Inadequate water-flow 	<ul style="list-style-type: none"> ◇Leak hunting and fill in standard quantity of refrigerant ◇Improve the heat insulation ◇Replace the drying filter ◇Clean the heat exchanger ◇Clean the water filter
The compressor doesn't work	<ul style="list-style-type: none"> ◇Power failure ◇Compressor contactor destroyed ◇Poor connection ◇Overheating protection ◇water outlet temperature is too high ◇Inadequate water-flow 	<ul style="list-style-type: none"> ◇Check it and solve the problems ◇Replace contactor ◇Check and renovate it ◇Check and solve the problems ◇Reset a proper temperature ◇Clean the water filter and discharge the air in the water system
The compressor works but too noisy	<ul style="list-style-type: none"> ◇Liquid refrigerant goes into the compressor ◇interior components destroyed ◇Inadequate refrigeration oil 	<ul style="list-style-type: none"> ◇Check the expansion valve ◇Replace the compressor ◇Add in adequate refrigeration oil
The fan doesn't work	<ul style="list-style-type: none"> ◇Capacitor damaged ◇The fans are not fixed well ◇The electromotor burned out ◇Contactor destroyed 	<ul style="list-style-type: none"> ◇Replace it ◇Fix it well again ◇Replace the electromotor ◇Replace the Contactor
Compressor works but not heating	<ul style="list-style-type: none"> ◇Refrigerant leakage ◇Compressor fault 	<ul style="list-style-type: none"> ◇Leak hunting and fill in standard quantity of refrigerant ◇Replace it
Low water-flow protection	<ul style="list-style-type: none"> ◇Hydraulic switch destroyed ◇Inadequate water-flow 	<ul style="list-style-type: none"> ◇Replace the switch ◇Clean the filter and discharge the air
Excessive discharge pressure	<ul style="list-style-type: none"> ◇excessive refrigerant ◇Incondensable gas in the Refrigeration cycle ◇Inadequate water-flow 	<ul style="list-style-type: none"> ◇Remove the superfluous refrigerant ◇Drive the gas out ◇Check the circulation and increase the flow
Low suction pressure	<ul style="list-style-type: none"> ◇Drying filter stoppage ◇Lack of refrigerant ◇Excessive pressure drop in the heat exchanger 	<ul style="list-style-type: none"> ◇Replace the filter ◇Leak hunting and fill in standard quantity of refrigerant ◇Check the opening of electronic expansion valve

Part VI Wiring Diagram

GT-SKR030B Wiring Diagram with commercial control system

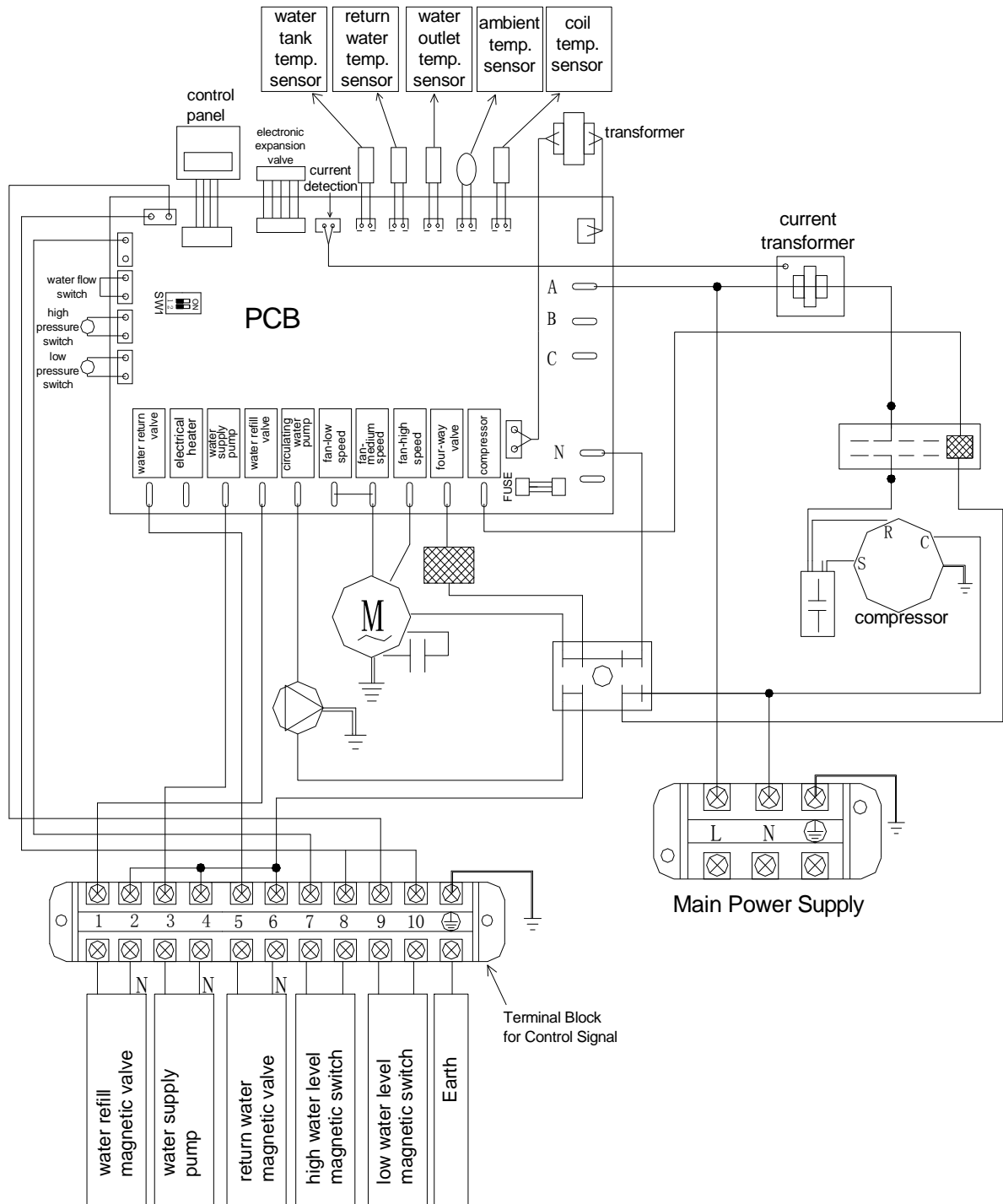

Note:

It is suggested to install extra AC contractor when the power of "circulating pump" and "water refill pump" are more than 500W respectively, because terminal block only provides control signals, it's prohibited to connect the power core to "Terminal Block for Control Signal" as it may damage the PCB.

Wiring Diagram GT-SKR050B (380V)

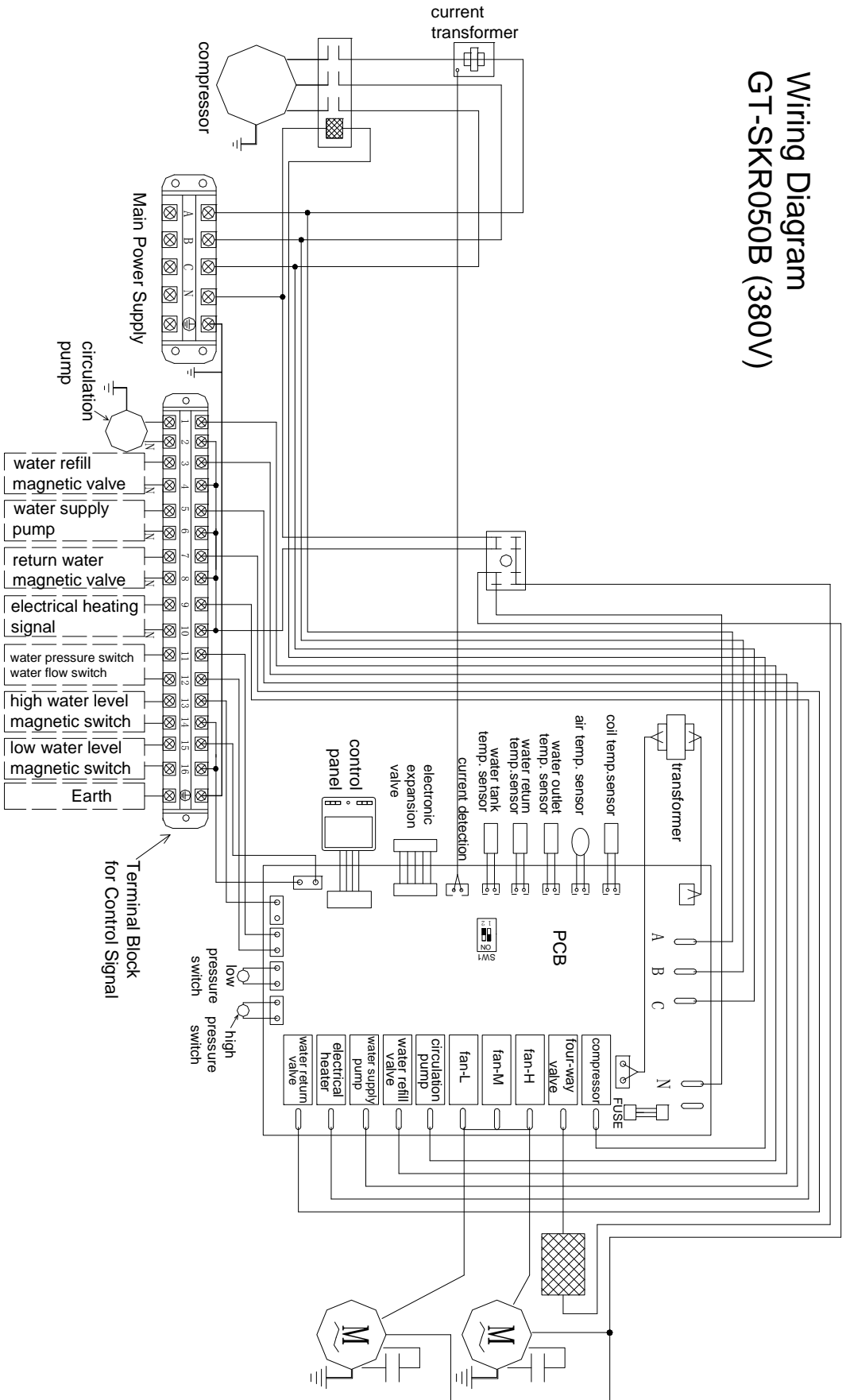

- Note:
1. It is suggested to install extra AC contractor when the power of "circulation pump" and "water refill pump" are more than 500W respectively.
 2. Users should install extra AC contractor when to install "water supply pump", "auxiliary electrical heater", because terminal block only provides control signals, it's prohibited to connect the power core to "Terminal Block for Control Signal" as it may damage the PCB.

Wiring Diagram GT-SKR030P/050P/070P(380V)

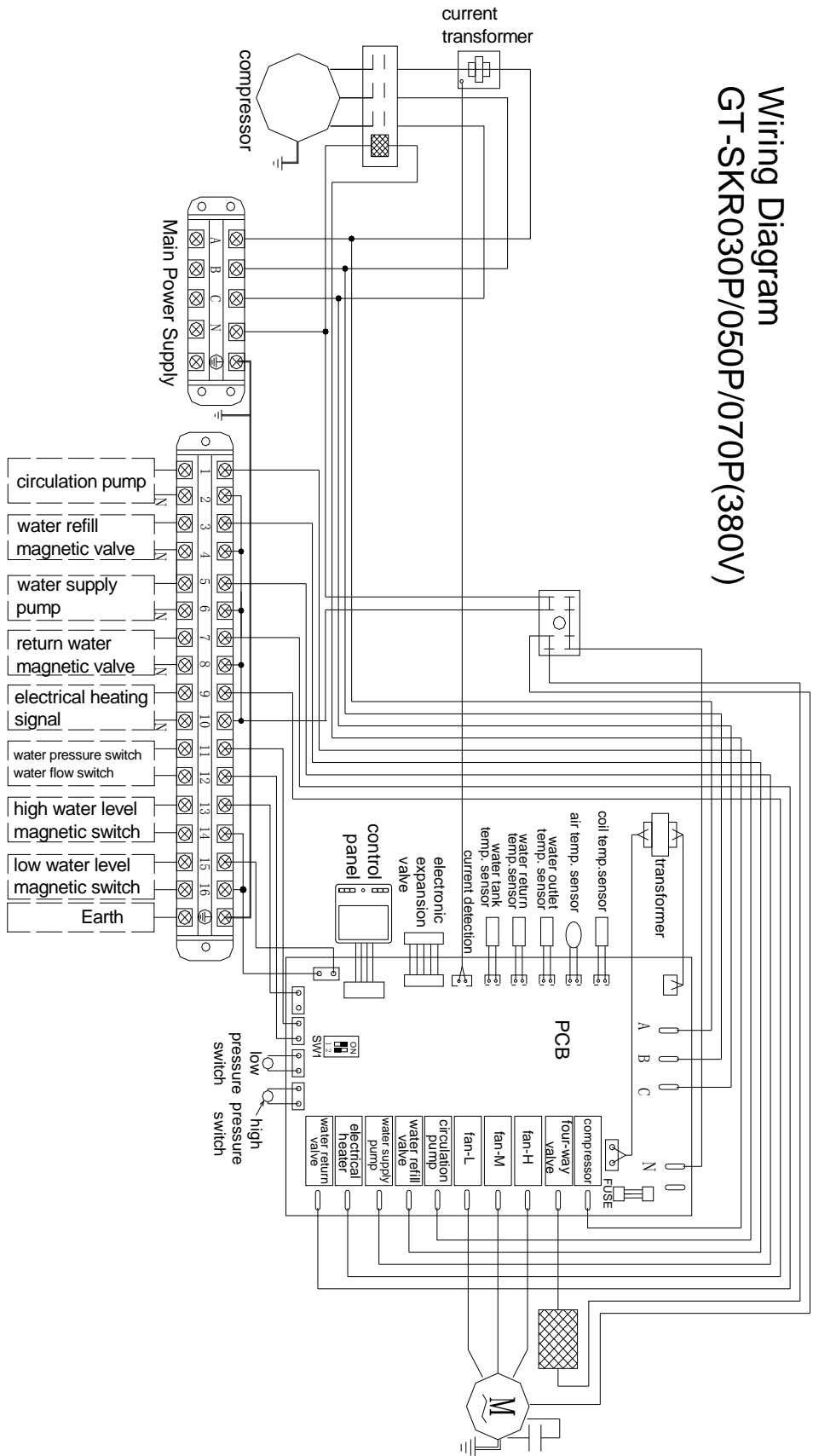

- Note:
1. It is suggested to install extra AC contractor when the power of "circulation pump" and "water refill pump" are more than 500W respectively.
 2. Users should install extra AC contractor when to install "water supply pump", "auxiliary electrical heater", because terminal block only provides control signals, it's prohibited to connect the power core to "Terminal Block for Control Signal" as it may damage the PCB.

Wiring Diagram GT-SKR100P (380V)

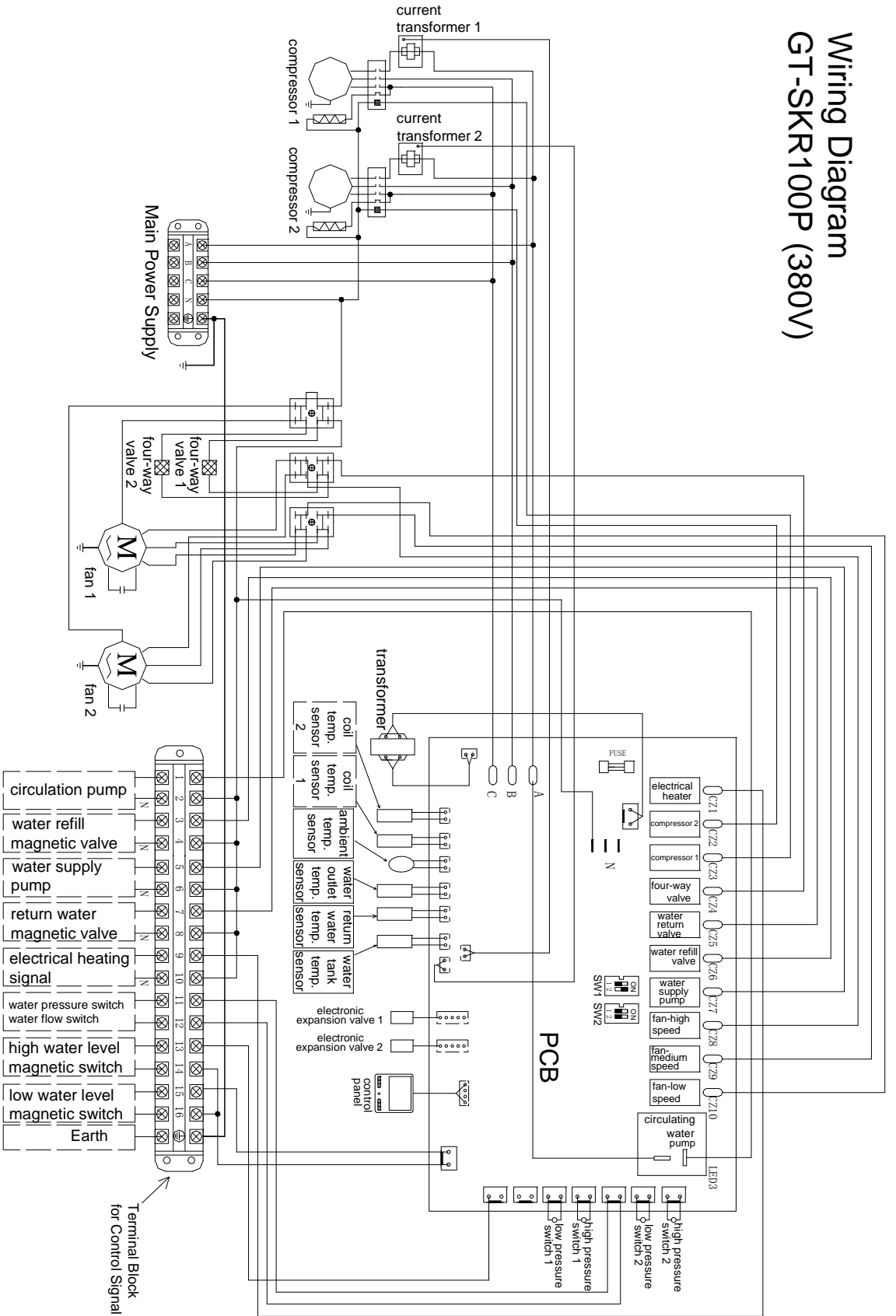

- Note:
1. It is suggested to install extra AC contractor when the power of "circulation pump" and "water refill pump" are more than 500W respectively.
 2. Users should install extra AC contractor when to install "water supply pump", "auxiliary electrical heater", because terminal block only provides control signals, it's prohibited to connect the power core to "Terminal Block for Control Signal" as it may damage the PCB.

Wiring Diagram GT-SKR150P (380V)

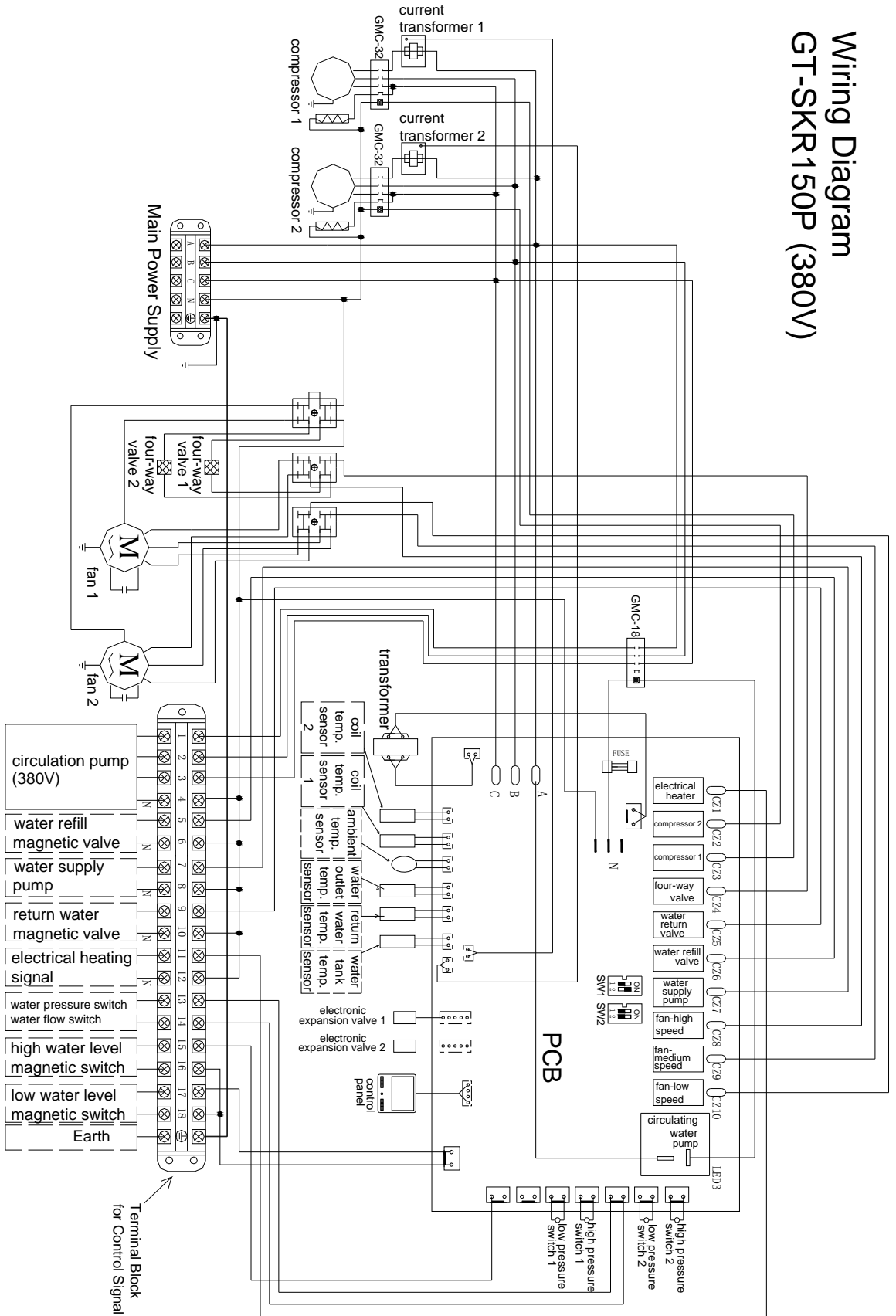

- Note:
1. It is suggested to install extra AC contractor when the power of "circulation pump" and "water refill pump" are more than 500W respectively.
 2. Users should install extra AC contractor when to install "water supply pump", "auxiliary electrical heater", because terminal block only provides control signals, it's prohibited to connect the power core to "Terminal Block for Control Signal" as it may damage the PCB.

There won't be a further notice if anything changes as the unit improved.