



Original operating instructions

Document number: 150001185_05_en

Version: 22/09/2023

RP201-11

Round baler

VariPack V 165 XC

From machine number: 1136331



Contact

Maschinenfabrik Bernard Krone GmbH & Co. KG
Heinrich-Krone-Straße 10
48480 Spelle
Germany

Telephone main office + 49 (0) 59 77/935-0
Telefax main office + 49 (0) 59 77/935-339
Telefax spare parts warehouse national territory + 49 (0) 59 77/935-239
Telefax spare parts warehouse export + 49 (0) 59 77/935-359
Internet www.krone-agriculture.com/de
<https://mykrone.green/>

Information for enquiries and orders

Model	
Vehicle identification number	
Year of manufacture	

Your dealer's contact details



For information on your KRONE machines, also refer to mykrone.green. After you have registered, you can generate and manage your machines via the machine number so that you can view the machine data. Via your personal account, you can also access all KRONE Services.



Technical Information Center (TIC)

Technical and service-relevant information on your KRONE machines can also be found in the [Technical Information Center](#). All information can be searched using a full-text search, such as operating instructions, spare parts information, training documents (qualification-based), error code and parameter descriptions, guided troubleshooting, video tutorials and much more.

1	Information on This Document.....	10
1.1	Validity	10
1.2	Significance of the document	10
1.3	Re-ordering	10
1.4	Applicable documents.....	10
1.5	Target group of this document	10
1.6	How to use this document.....	11
1.6.1	Directories and references	11
1.6.2	Information on direction	11
1.6.3	Term “machine”	11
1.6.4	Figures	11
1.6.5	Scope of the document	11
1.6.6	Means of representation	11
1.6.7	Conversion table	14
2	Safety	15
2.1	Intended use	15
2.2	Reasonably foreseeable misuse	15
2.3	Service life of the machine	16
2.4	Basic safety instructions	16
2.4.1	Importance of operating instructions	16
2.4.2	Personnel qualification of the operating personnel	16
2.4.3	Personnel qualification of the technicians	17
2.4.4	Children in danger.....	17
2.4.5	Connecting the machine	17
2.4.6	Structural modifications on the machine	17
2.4.7	Additional equipment and spare parts	17
2.4.8	Jobs on the machine	18
2.4.9	Operational safety: Technically sound condition.....	18
2.4.10	Danger zones.....	19
2.4.11	Ensuring functionality of safety devices	21
2.4.12	Personal protective equipment	21
2.4.13	Safety sign on the machine.....	22
2.4.14	Road safety	22
2.4.15	Parking the machine safely	23
2.4.16	Consumables	23
2.4.17	Dangers arising from environment.....	24
2.4.18	Sources of danger on the machine	25
2.4.19	Dangers in connection with certain activities: Working on the machine	26
2.4.20	Dangers in connection with certain activities: working on wheels and tyres	27
2.4.21	Behaviour in dangerous situations and in case of accidents	28
2.5	Safety routines	28
2.5.1	Shutting down and safeguarding the machine	28
2.5.2	Securing raised machine and machine parts against lowering	29
2.5.3	Carrying out oil level check and oil and filter element changes safely	29
2.5.4	Running actuator test.....	30
2.6	Safety sign on the machine.....	30
2.7	Information signs on the machine	35
2.8	Safety equipment	40
2.8.1	SMV emblem	42
3	Data memory	43
4	Machine description	44
4.1	Machine overview	44
4.2	Overload protections on the machine	45
4.3	Identification plate	45
4.4	Scope of delivery	46
4.5	Function description net wrapping	47
4.6	Function description of twine tying.....	48
4.7	Function description cutting unit	49
5	Technical data	50

5.1	Dimensions	50
5.2	Weights	50
5.3	Technically permitted maximum speed (road travel)	50
5.4	Airborne noise emission	50
5.5	Ambient temperature	51
5.6	Tyres	51
5.7	Safety chain	51
5.8	Bale dimensions	51
5.9	Twine wrapping and tying material	51
5.10	Net wrapping and tying material	51
5.11	Requirements for tractor - power	52
5.12	Tractor requirements – hydraulics	52
5.13	Requirements for tractor – electrics	52
5.14	Requirements for tractor – brake system	52
5.15	Consumables	52
5.15.1	Oils	53
5.15.2	Lubricating greases	53
6	Initial operation	54
6.1	Checklist for initial operation	54
6.2	Scope of delivery	54
6.3	Adjusting the drawbar height	55
6.4	Universal shaft	57
6.4.1	Mounting the universal shaft on the machine	57
6.4.2	Adjusting the length of the universal shaft	58
6.4.3	Mounting universal shaft bracket	58
7	Commissioning	59
7.1	Connecting machine to tractor	59
7.2	Mounting the universal shaft on the tractor	60
7.3	Connecting hydraulic hoses	61
7.4	Connecting hydraulic brake (export)	62
7.5	Connecting/disconnecting compressed air connections for the compressed air brake	62
7.6	Connecting the road lighting	63
7.7	Mounting safety chain	64
7.8	Mounting the catch loop	65
7.9	Connecting the KRONE DS 100 operation unit	66
7.10	Connecting KRONE terminal DS 500	67
7.11	Connecting the KRONE ISOBUS terminal (CCI 800, CCI 1200)	69
7.12	Connecting foreign ISOBUS terminal	71
7.13	Connecting joystick	72
7.14	Connecting the camera to the KRONE ISOBUS terminal CCI 800 or CCI 1200	75
8	Operation	76
8.1	Preparation before baling	76
8.2	Filling the bale chamber	77
8.3	Completing the baling process, starting tying cycle and ejecting round bales	79
8.4	Reducing the pressure on the side walls of the bale chamber	79
8.5	Operating the support jack	79
8.6	Releasing/applying the parking brake	81
8.7	Using ladders for the tying system	82
8.8	Fitting wheel chocks	82
8.9	Removing/mounting the safety device which prevents unauthorised use	83
8.10	Pick-up	84
8.10.1	Bringing the pick-up to transport/working position	84
8.10.2	Setting the pick-up working height	85
8.10.3	Activating/deactivating the bearing pressure relief for the pick-up	85
8.11	Crop press roller unit	87
8.11.1	Setting the crop press roller unit	87
8.11.2	Removing/mounting the baffle sheet on the crop press roller unit	88
8.12	Cutting unit	88
8.12.1	Lifting/lowering blade cassette	88

8.12.2	Swivelling in/out blades.....	90
8.12.3	Swivelling blade groups in/out	91
8.12.4	Storing blades on the blade support	93
8.13	Net wrapping	94
8.13.1	Inserting the net roll	94
8.13.2	Inserting the net	96
8.13.3	Cutting the net.....	97
8.13.4	Using pivoted wrapping and tying material supply.....	98
8.14	Twine tying.....	100
8.14.1	Connecting spools of twine with each other.....	100
8.14.2	Inserting tying twine	101
8.14.3	Swivelling the twine box to and fro.....	104
8.15	Open/close tailgate	104
8.16	Using the stop cock of the tailgate	105
8.17	Removing crop blockages.....	105
8.17.1	Crop blockage at the right-hand and left-hand end of the pick-up	105
8.17.2	Crop blockage under the cutting rotor.....	106
8.17.3	Crop blockage in the baling element.....	107
9	KRONE operation unit DS 100	108
9.1	Overview	108
9.2	Switching the operation unit on/off.....	110
9.3	Call road travel screen	110
9.4	Accessing the working screen	111
9.5	Direction display.....	111
9.6	Start tying.....	112
9.7	Switching the working lights on/off.....	113
9.8	Switching warning beacon on/off	113
9.9	Setting the bale diameter	113
9.10	Setting advance signaling	114
9.11	Setting the sensitivity of the direction display	115
9.12	Setting the baling pressure	115
9.13	Setting the core, centre and edge of the round bale.....	116
9.14	Setting the number of net layers	119
9.15	Setting the tying start delay.....	119
9.16	Displaying the customer counter.....	120
9.17	Sensor test for digital and analogue sensors.....	121
9.18	Calibrating sensors	123
9.19	Actuator test for digital and analogue actuators.....	124
9.20	Error messages.....	126
9.21	Manual operation of the tying system	127
9.22	Setting user preferences.....	128
10	KRONE Terminal DS 500	129
10.1	Touchable display	129
10.2	Switching terminal on/off.....	129
10.3	Design DS 500.....	130
11	KRONE ISOBUS terminal (CCI 800, CCI 1200)	132
11.1	Touchable display	132
11.2	Switching terminal on/off.....	133
11.3	Design of display.....	134
11.4	Design of the KRONE machine application	134
11.5	Setting units on the terminal	135
12	Foreign ISOBUS terminal	136
12.1	Varying functions to KRONE ISOBUS terminal	136
13	Terminal machine functions	137
13.1	Status line	137
13.2	Keys	138
13.3	Displays on the working screen	140
13.4	Displays on the information bar	142

13.5	Direction display	143
13.6	ISOBUS Shortcut Button (ISB)	145
13.7	Accessing the working screen	146
13.8	Automatic call of the Road travel screen	147
13.9	Adjusting bale diameter	147
13.10	Operating TIM 1.0 (Tractor Implement Management)	148
13.10.1	Mode of operation of TIM 1.0	148
13.10.2	TIM displays and keys on the working screen	149
13.10.3	Activating TIM functions	150
13.10.4	Pausing TIM functions	151
13.11	Operating machine via joystick	151
13.11.1	Auxiliary functions (AUX)	151
13.11.2	Auxiliary assignment of a joystick	152
14	Terminal menus	155
14.1	Menu structure	155
14.2	Recurrent icons	156
14.3	Selecting a menu Level	157
14.4	Selecting a menu	157
14.5	Changing value	158
14.6	Changing mode	159
14.7	Tying in the menu level	160
14.8	Menu 1 "Number of net layers" (net wrapping)	161
14.9	Menu 1 "Number of twine layers" (twine tying)	161
14.10	Menu 3 "Advance signalling"	162
14.11	Menu 4 "Tying start delay"	162
14.12	Menu 6 "Electronic baling pressure adjustment"	163
14.13	Menu 7 "Sensitivity of direction display"	164
14.14	Menu 8 "Select type of tying" (for the "Net wrapping and twine tying" version)	165
14.15	Menu 9 "Filling correction"	166
14.16	Menu 10 "Manual operation" (for the "Net wrapping" version)	167
14.17	Menu 10 "Manual operation" (for version with "net wrapping and twine tying")	168
14.18	Menu 11 "Correction of start/end position of the twine tying system (for "net wrapping and twine tying" version)	170
14.19	Menu 12 "Moisture measurement"	172
14.19.1	Menu 12-1 "Error message for moisture measurement"	172
14.19.2	Menu 12-2 "Correction value for moisture measurement"	173
14.20	Menu 13 "Counters"	175
14.20.1	Menu 13-1 "Customer counter"	175
14.20.2	Menu 13-2 "Total counter"	177
14.21	Menu 14 "ISOBUS"	178
14.21.1	Menu 14-5 "KRONE SmartConnect"	179
14.21.2	Menu 14-6 "Configuring TIM software" (for "TIM 1.0" version)	180
14.21.3	Menu 14-9 "Switching between terminals"	181
14.22	Menu 15 "Settings"	182
14.22.1	Menu 15-1 "Sensor test"	183
14.22.1.1	Adjusting sensor B08 "Top blade cassette"	185
14.22.1.2	Adjusting sensor B61 "Tying 1 (passive)"	186
14.22.2	Menu 15-2 "Actuator test"	187
14.22.3	Menu 15-3 "Software info"	189
14.22.4	Menu 15-4 "Error list"	189
15	Driving and transport	192
15.1	Preparing the machine for road travel	193
15.2	Parking the machine	193
15.3	Securing the universal shaft	194
15.4	Checking road travel lighting	195
15.5	Dismounting the guide wheels of the pick-up for road travel	195
15.6	Preparing the machine for shipment	196
15.6.1	Checklist for the transport of the machine	196
15.6.2	Securing the front hood	197
15.6.3	Lifting the machine	197

15.6.4	Lashing the machine	198
16	Settings	200
16.1	Setting the baling pressure	200
16.2	Setting the bale diameter	200
16.3	Setting net overhang on the wrapping material brake	200
16.4	Setting rubber cloth on the net wrapping	201
16.5	Adjusting the twine tension at the twine box	201
16.6	Adjusting the twine tension at the twine brake	202
16.7	Checking/adjusting blades at the twine tying system	202
16.8	Setting oil quantities for the central chain lubrication unit	204
16.9	Setting the cutting length	205
16.10	Setting the bale ejector	205
17	Service & maintenance	207
17.1	Observe the service record booklet	207
17.2	Maintenance table	207
17.2.1	Maintenance – Before the season	207
17.2.2	Maintenance – After the season	208
17.2.3	Maintenance – once after 10 hours	208
17.2.4	Maintenance – once after 50 hours	209
17.2.5	Maintenance – Once after 500 round bales	209
17.2.6	Maintenance – every 10 hours, at least daily	209
17.2.7	Maintenance – every 50 hours	209
17.2.8	Maintenance – Every 250 hours	210
17.2.9	Maintenance – Every 500 hours	210
17.2.10	Maintenance – Every 1,000 round bales	210
17.2.11	Maintenance – Every 2 years	210
17.3	Lubrication chart	210
17.4	Lubricating the universal shaft	214
17.5	Tightening torques	215
17.6	Checking/maintaining tyres	218
17.7	Servicing the main gearbox	220
17.8	Cleaning the machine	221
17.9	Clean the bushing and the drawbar eye	223
17.10	Cleaning drive chains	223
17.11	Relieving baling belts	224
17.12	Checking the screw connections on the drawbar	224
17.13	Checking and adjusting the cleaning rollers	225
17.14	Checking and adjusting scraper on the feed roller	227
17.15	Checking the fire extinguisher	228
17.16	Removing corrosion from net support / holder	228
17.17	Releasing the cam clutch on the universal shaft	229
17.18	Briefly deactivating cutting unit and pick-up	229
17.19	Changing the blades	229
17.20	Unlocking/locking blade retaining shaft	231
17.21	Checking and moving the blade retaining shaft	232
17.22	Grinding the blades	233
17.23	Checking/lubricating the safety rolls of the single blade locking device	234
17.24	Adjust drive chains	234
17.24.1	Drive chain of the baling unit (no. 1)	235
17.24.2	Drive chain of the rotor (no. 2)	236
17.24.3	Drive chain of the feed roller and the starter roller (no. 3)	236
17.25	Servicing chain lubrication unit	237
17.25.1	Checking oil level, topping up oil and cleaning filter	237
17.25.2	Position of the oil brushes	238
17.26	Servicing compressed air brake (for version with "Compressed air brake")	239
17.26.1	Clean air filter	239
17.26.2	Drain condensation water from the compressed air tank	240
17.26.3	Retighten tensioning straps at the compressed air tank	241
17.27	Servicing the hydraulic system	241
17.27.1	Before working on the hydraulic system	242

17.27.2	Checking hydraulic hoses	242
18	Malfunction, cause and remedy	243
18.1	Disturbances at the pick-up or during picking up of crops	243
18.2	Disturbances during or after the baling process	244
18.3	Disturbances at the tying unit or during the tying cycle.....	246
18.4	Malfunctions on the chain lubrication unit.....	248
18.5	Faults of the electrics/electronics.....	249
18.5.1	Error Messages.....	249
18.5.1.1	Possible error types (FMI).....	250
18.5.2	Remedying sensor/actuator error	251
18.6	Checking the ratchet on the wrapping material brake.....	251
18.7	Checking positions of the feed rocker arm.....	252
18.8	Setting the tailgate lock.....	254
18.9	Checking the pressure limiting valve	255
18.10	Filling the accumulator	255
18.11	Cleaning deflection rolls and baling belts.....	256
18.12	Car jack contact points.....	256
19	Waste disposal	258
20	Index.....	259
21	Declaration of conformity	269

1 Information on This Document

1.1 Validity

This document is valid for machines of type:

RP201-11 (VariPack V 165 XC)

All information, illustrations and technical data in this document correspond to the latest state at the time of publication.

We reserve the right to make design changes at any time and without notification of reasons.

1.2 Significance of the document

This is an important document. It is addressed to the user and contains safety-relevant information.

- ▶ Prior to starting work, read the complete document and observe its contents.
- ▶ Keep this document ready to hand in the document storage tube for the user of the machine, *see Page 44*.
- ▶ Hand over this document to subsequent users.

1.3 Re-ordering

If this document has become completely or partially unusable or if another language is required, you can request a replacement document by quoting the document number indicated on the cover sheet. Furthermore, the document can also be downloaded online via KRONE MEDIA <https://media.mykrone.green> or via the TIC <https://mykrone.green/control/subsystemauth?system=S017>.

1.4 Applicable documents

To ensure that the machine is used safely and as intended, observe the following further applicable documents.

- Operating instructions for universal shaft
- Operating instructions terminal
- AUX joystick operating instructions
- Supplement to operating instructions "Error messages"
- Circuit diagram, KRONE
- Spare parts list, KRONE
- Service record booklet, KRONE

1.5 Target group of this document

This document aims at the operator of the machine who fulfills the minimum requirements of personnel qualification, *see Page 16*.

1.6 How to use this document

1.6.1 Directories and references

Contents/headers

The contents and headers in this document ensure quick orientation in the chapters.

Index

The index contains catchwords in alphabetical order which enable to find information on a desired topic easily. The index can be found on the last pages of this document.

Cross references

Cross references to another place in the document or to another document are in the text with page number.

Examples:

- Check the tight seat of all screws on the machine, [see Page 11](#). (INFO: If you use an electronic version of this document, click on the link to go to the specified page.)
- For further information, refer to the operating instructions of the universal shaft manufacturer.

1.6.2 Information on direction

Directional information in this document, such as front, rear, right and left, applies in the direction of travel of the machine.

1.6.3 Term “machine”

Throughout the rest of this document, the “round baler” will also be referred to as the “machine”.

1.6.4 Figures

The figures in this document do not always represent the exact machine type. The information that refers to the figure always corresponds to the machine type of this document.

1.6.5 Scope of the document

In addition to standard equipment, accessories kits and versions of the machine are described in this document. Your machine may deviate from this document.

1.6.6 Means of representation

Icons in the text

The following means of representation (icons) are used to present the text more clearly:

- ▶ This arrow characterizes an **action step**. Several arrows in a row identify a sequence of actions to be performed step by step.
- ✓ This icon identifies a **prerequisite** that has to be fulfilled to perform an action step or a sequence of actions.
- ⇒ This arrow marks the **intermediate result** of an action step.
- ➔ This arrow identifies the **result** of an action step or sequence of actions.
- This bullet point identifies an **enumeration**. If the bullet point is intended, it identifies the second level of the enumeration.

Icons in figures

The following icons can be used in illustrations:

Icon	Explanation	Icon	Explanation
①	Reference sign for part	I	Position of a part (e.g. move from position I to position II)
X	Dimensions (e. g. also W = width, H = height, L = length)		Magnification of display detail
LH	Left side of machine	RH	Right side of machine
	Direction of travel	↑	Direction of motion
—	Reference line for visible material	-----	Reference line for covered material
-----	Centre line	—	Cable routes
	Open		Closed
	Apply liquid lubricant (e.g. lubricating oil)		Apply lubricating grease

Warning signs

Warnings of dangers are separated from the remaining text as warning signs and are identified with a danger sign and signal words.

The warning signs must be read and the measures must be observed in order to prevent personal injury.

Explanation of danger sign



This is the danger sign that warns of a risk of injury.

Please observe all notes marked with the danger sign in order to avoid injuries or death.

Explanation of signal words

 **DANGER**

The signal word DANGER warns of a hazardous situation which will result in serious injuries or death if the warning sign is ignored.

 **WARNING**

The signal word WARNING warns of a hazardous situation which will result in serious injuries or death if the warning sign is ignored.

 **CAUTION**

The signal word CAUTION warns of a hazardous situation which will result in minor to moderate injuries if the warning sign is ignored.

Example of a warning sign:

 **WARNING**

Eye damage caused by flying dirt particles

When cleaning with compressed air, dirt particles are ejected at high speed and could get into the eyes. Therefore eyes could be hurt.

- ▶ Keep people away from the working area.
- ▶ Wear personal protective equipment when performing cleaning work with compressed air (e.g. eye protection).

Warnings of property damage/environmental damage

Warnings of property/environmental damage are separated from the remaining text and marked with "Notice".

Example:

NOTICE

Gearbox damage due to low oil level

The gearboxes could be damaged when the oil level is too low.

- ▶ Check gear oil level at regular intervals and top up oil, if necessary.
- ▶ Check gear oil level approx. 3 to 4 hours after the machine has been switched off. Check oil level only when machine is in horizontal position.

Notices with information and recommendations

Additional information and recommendations for trouble-free and productive operation of the machine are separated from the remaining text and marked with "Information".

Example:

INFO

Each safety sign is provided with an order number and can be ordered directly from the manufacturer or from an authorised specialist dealer.

1.6.7 Conversion table

The following table can be used to convert metric units into US units.

Size	SI units (metric)		Factor	Inch-pound units	
	Unit name	Abbreviation		Unit name	Abbreviation
Area	Hectare	ha	2.47105	Acre	acres
Volume flow	Litres per minute	L/min	0.2642	US gallons per minute	gpm
	Cubic metres per hour	m ³ /h	4.4029		
Force	Newton	N	0.2248	Pound force	lbf
Length	Millimetre	mm	0.03937	Inch	in.
	Metre	m	3.2808	Foot	ft.
Power	Kilowatt	kW	1.3410	Horsepower	hp
Pressure	Kilopascal	kPa	0.1450	Pounds per square inch	psi
	Megapascal	MPa	145.0377		
	bar (non-SI)	bar	14.5038		
Torque	Newtonmeter	Nm	0.7376	pound-foot or foot-pound	ft·lbf
			8.8507	pound-inch or inch-pound	in·lbf
Temperature	Degrees Celsius	°C	°C×1.8+32	Degrees Fahrenheit	°F
Velocity	Metres per minute	m/min	3.2808	Feet per minute	ft/min
	Metres per second	m/s	3.2808	Feet per second	ft/s
	Kilometres per hour	km/h	0.6215	Miles per hour	mph
Volumes	Litres	L	0.2642	US gallon	US gal.
	Millilitre	ml	0.0338	US ounce	US oz.
	Cubic centimetre	cm ³	0.0610	Cubic inch	in ³
Weight	Kilogram	kg	2.2046	Pound	lbs

2 Safety

2.1 Intended use

This machine is a round baler and is used to press crops to round bales.

The crops designated for the intended use of this machine are cut stalk and leaf crops.

The machine can be used to bale wilted and dry crop stalks and leaf material (e.g. hay and straw). When used in damp and/or sticky conditions, slippage and wrapping may occur on the drive rolls and deflection rolls and baling must be stopped. The moisture content of the crop should not exceed 50%. Use in maize straw is not permitted.

The machine is designed exclusively for use in agriculture and may only be used when

- all safety devices are available according to the operating instructions and are located in the protective position.
- all safety instructions of the operating instructions have been observed and complied with, both in chapter "Basic safety instructions", [see Page 16](#), and directly in the chapters of the operating instructions.

The machine may be used only by people who satisfy the personnel qualification requirements designated by the machine manufacturer, [see Page 16](#).

These operating instructions are part of the machine and must therefore be at hand when the machine is in use. The machine may be operated only when the operator has received training and in compliance with these operating instructions.

If the machine is used for applications which are not described in these operating instructions, this may result in serious injuries or death and damage to the machine and other property.

Unauthorised modifications to the machine may affect the properties of the machine or disrupt the proper operation. For this reason, unauthorised modifications shall exclude any liability of the manufacturer for consequential damage.

The intended use shall also include the adherence to the operating, maintenance and repair conditions set by the manufacturer.

2.2 Reasonably foreseeable misuse

Any use beyond the intended use [see Page 15](#) is regarded as improper use and is therefore misuse according to the Machinery Directive. The manufacturer is not liable for damage resulting from this, the user alone bears the risk.

Such misuse is for example:

- Processing of crops which are outside the intended use of the machine, [see Page 15](#)
- Transport of people
- Transport of goods
- Exceeding the permitted technical gross weight
- Non-compliance with the safety labels on the machine and safety notes in the operating instructions
- Performing troubleshooting, setting, cleaning, repair and maintenance work contrary to the information in the operating instructions
- Unauthorised modifications to the machine
- Attachment of unauthorised or unapproved additional equipment
- Use of spare parts which are not KRONE original spare parts
- Stationary operation of the machine

Unauthorised modifications to the machine may affect the properties of the machine or disrupt proper operation. For this reason, unauthorised modifications will exclude any liability of the manufacturer for consequential damage.

2.3 Service life of the machine

- The service life of this machine depends on its proper operation and maintenance as well as the operating and harvesting conditions.
- By heeding the instructions and information in these operating instructions, permanent operational readiness and a long service life of the machine can be achieved.
- After each operating season, inspect the entire machine for wear and other damage.
- Replace damaged and worn components before recommissioning the machine.
- Carry out a full technical inspection of the machine after five years of machine operation and make a decision on further machine usage taking the results of this inspection into account.
- Theoretically, the service life of this machine is unlimited as all worn or damaged components can be replaced.

2.4 Basic safety instructions

Non-compliance with the safety instructions and warnings

Non-compliance with the safety instructions and warnings may result in injuries and damage to the environment and property.

2.4.1 Importance of operating instructions

The operating instructions are an important document and a part of the machine. They are intended for the user and contain information that is relevant to safety.

Only the procedures specified in the operating instructions are safe. If the operating instructions are not followed, there is a risk of serious or even fatal injuries.

- ▶ Prior to using the machine for the first time, read and observe the "Basic safety notices" completely.
- ▶ Prior to starting work, read and observe the respective sections in the operating instructions too.
- ▶ Keep the operating instructions ready to hand for the user of the machine in the document storage tube, [see Page 44](#).
- ▶ Hand over the operating instructions to subsequent users.

2.4.2 Personnel qualification of the operating personnel

If the machine is not used properly, people may be seriously injured or killed. To avoid accidents, each person who works with the machine must satisfy the following minimum requirements:

- He is physically capable of controlling the machine.
- He can work safely with the machine in accordance with these operating instructions.
- He understands the method of operation of the machine within the scope of his work and can identify and avoid the dangers associated with the work.
- He has read the operating instructions and can implement the information in the operating instructions accordingly.
- He is familiar with driving vehicles safely.
- For road travel he has adequate knowledge of the highway code and has the stipulated driving licence.

2.4.3 Personnel qualification of the technicians

If the work (assembly, conversion, modification, extension, repairs, retrofitting) is performed improperly on the machine, people may be seriously or fatally injured. To avoid accidents, everyone who performs work according to these instructions must meet the following minimum requirements:

- Qualified professional, with relevant training.
- Capable of assembling the (partially) disassembled machine according to the assembly instructions provided by the manufacturer.
- He is capable, e.g. by attending a training course, of extending, modifying or repairing the function of the machine according to the relevant instructions provided by the manufacturer.
- He has read the operating instructions and can implement the information in the operating instructions accordingly.
- Ability to perform the work safely according to these instructions.
- Understands the mode of operation of the work to be performed and the machine and is able to identify and avoid risk in carrying out the necessary work.
- Has read these instructions and is able to implement the information explained in these instructions accordingly.

2.4.4 Children in danger

Children are not in a position to assess dangers and behave unpredictably.

Thus children are particularly at risk.

- ▶ Keep children away from the machine.
- ▶ Keep children away from consumables.
- ▶ Make sure that there are no children in the danger zone, especially when starting and triggering machine movements.

2.4.5 Connecting the machine

When tractor and machine are not correctly connected, there is a risk of causing serious accidents.

- ▶ When connecting, follow all operating instructions:
 - the operating instructions of the tractor
 - the operating instructions of the machine, [see Page 59](#)
 - the operating instructions of universal shaft
- ▶ Observe the changed driving behaviour of the combination.

2.4.6 Structural modifications on the machine

Structural modifications and extensions that were not approved by KRONE can impair the functionality, operational safety and also the road traffic certification of the machine. As a result, persons can be seriously injured or killed.

Any structural modifications and extensions that are not authorised by KRONE are not permitted.

2.4.7 Additional equipment and spare parts

Additional equipment and spare parts that do not correspond to the requirements of the manufacturer may affect the operational safety of the machine and cause accidents.

- ▶ To ensure operational safety, use original parts or standard parts which correspond to the requirements of the manufacturer.

2.4.8 Jobs on the machine

Passengers

Passengers may be seriously injured by the machine or fall off the machine and run over. Ejected objects may strike and injure passengers.

- ▶ Never carry passengers on the machine.

2.4.9 Operational safety: Technically sound condition

Operation only after proper commissioning

The operational safety of the machine is not guaranteed without proper commissioning in accordance with these operating instructions. This may result in accidents and people may be seriously or fatally injured.

- ▶ Use the machine only after proper commissioning, [see Page 59](#).

Technically sound state of the machine

Improper maintenance and setting could influence the operational safety of the machine and cause accidents. Thus there is a risk of serious injuries or death.

- ▶ All maintenance and setting work must be performed according to the chapters "Maintenance and Setting".
- ▶ Before performing any maintenance and setting work, shut down and safeguard the machine, [see Page 28](#).

Danger resulting from damage to the machine

Damage to the machine may impair the operational safety of the machine and cause accidents. As a result, people may be seriously injured or killed. The following parts of the machine are particularly important for safety:

- Brakes
- Steering
- Safety Devices
- Connecting devices
- Lighting
- Hydraulics
- Tyres
- Universal shaft

If there are doubts about the operational safety of the machine, for example due to an unexpected change to the operational behaviour, visible damage or leaking consumables:

- ▶ Shut down and safeguard the machine, [see Page 28](#).
- ▶ Immediately eliminate potential causes of damage, for example heavy soiling, or tighten slack screws.
- ▶ Determine the cause of damage according to these operating instructions and repair the damage, if possible, [see Page 243](#).
- ▶ In case of damage which may affect operational safety and cannot be repaired according to these operating instructions: Have damage repaired by a qualified service centre.

Technical limit values

If the technical limit values of the machine are not observed, the machine may be damaged. As a result, accidents may occur and people may be seriously or fatally injured. With regard to safety, it is especially important to observe the following technical limit values:

- maximum permitted operating pressure of the hydraulics
 - maximum permitted drive speed
 - maximum permitted total weight
 - maximum permitted axle load/axle loads
 - maximum permitted drawbar load
 - maximum permitted axle loads of the tractor
 - maximum permitted transport height and width
 - maximum permitted speed
- ▶ Comply with limit values, [see Page 50](#).

2.4.10 Danger zones

If the machine is switched on, its surrounding can present a danger zone.

Avoid entering the danger zone of the machine by observing the minimum safety distance.

If the safety distance is not observed, people may be seriously injured or killed.

- ▶ Do not switch on the drives and engine if the minimum safety distance has not been observed.
- ▶ If people fail to observe the minimum safety distance, switch off the drives.
- ▶ Switch the machine off in shunting and field mode.

The safety distance is:

For machine in shunting and field mode	
In front of the machine	3 m
Behind the machine	5 m
On either side of the machine	3 m
For machine switched on without driving motion	
In front of the machine	3 m
Behind the machine	5 m
On either side of the machine	3 m

The safety distances specified here are minimum distances in terms of intended use. If necessary, these safety distances must be increased according to the operating and ambient conditions.

- ▶ Before working in front of and behind the tractor and in the danger zone of the machine: Shut down and secure the machine, [see Page 28](#). This also applies to brief inspection work.
- ▶ Consider the information in all relevant operating instructions:
 - the operating instructions for the tractor
 - the operating instructions of the machine
 - the operating instructions of universal shaft

Danger zone universal shaft

People may be caught, pulled in and seriously injured by the universal shaft.

- ▶ Observe operating instructions of universal shaft.
- ▶ Ensure sufficient overlap of section tube and universal shaft guards.
- ▶ Make sure that the universal shaft guards are mounted and that they are fully functional.
- ▶ Allow the universal shaft locks to engage. There must be no areas of the locking device on the PTO shaft fork which could cause catching or entrapment (e.g. by annular design, protective collar around the locking pin).
- ▶ Attach chains to prevent the universal shaft guards from rotating with the shaft.
- ▶ Make sure that there is no one in the danger zone of PTO shaft and universal shaft.
- ▶ Ensure that the selected speed and direction of rotation of the PTO shaft of the tractor match the permitted speed and direction of rotation of the machine.
- ▶ Switch off the PTO shaft when the angles between the universal shaft and the PTO shaft are too large. The machine may be damaged. Parts may be hurled up and cause injury to people.

Danger zone PTO shaft

People may be caught, pulled in and seriously injured by the PTO shaft and the driven components.

Before switching on the PTO shaft:

- ▶ Ensure that all protective devices are mounted and brought into protective position.
- ▶ Make sure that there is no one in the danger zone of PTO shaft and universal shaft.
- ▶ Switch off drives if they are not needed.

Danger zone between tractor and machine

People standing between the tractor and machine may be seriously injured or killed if the tractor rolls away or by carelessness or machine movements:

- ▶ Before carrying out any work between the tractor and the machine: Always turn off and secure the machine, [see Page 28](#). This also applies to brief inspection work.
- ▶ If the lifting device must be actuated, instruct all people to keep away from the range of movement of the lifting device.

Danger zone when drive is switched on

When the drive is switched on, there is a danger to life caused by rotating machine parts. Ensure that there are no persons in the danger zone of the machine.

- ▶ Before starting the machine, instruct all people to leave the danger zone of the machine.
- ▶ In case of dangerous situations, immediately switch off drives and instruct people to leave the danger zone.

Danger zone due to trailing machine parts

If machine parts are trailing, people may be seriously injured or killed.

After the drives have been switched off, the following machine parts will trail:

- universal shaft
- Drive chains
- Pick-up
- Cutting rotor
- Tying unit
- bale formation conveyor
- ▶ Shut down and safeguard the machine, *see Page 28*.
- ▶ Do not attempt to approach the machine until all moving machine parts have come to a standstill.

2.4.11 Ensuring functionality of safety devices

If safety devices are missing or damaged, people may be seriously injured or killed by moving machine parts.

- ▶ Replace damaged safety devices.
- ▶ Mount dismantled safety devices and machine parts again before start-up and move them to protective position.
- ▶ If it is doubtful whether all safety devices have been correctly installed and are functional, have a service centre check them.

Keeping universal shaft guard functional

The overlap of universal shaft and protective cap on the machine must not be less than 50 mm. This minimum overlap is also required for protective devices of wide-angle universal shaft and if couplings or other components are used. If the operator has to reach between the universal shaft guard and the protective cap to connect the universal shaft, the clearance on one level must be at least 50 mm. On all levels the clearance must be no more than 150 mm.

2.4.12 Personal protective equipment

The wearing of personal protective equipment is an important safety measure. Missing or unsuitable personal protective equipment increases health risks and injuries.

Personal protective equipment includes, for example:

- Suitable protective gloves
- Safety shoes
- Tight-fitting protective clothing
- Hearing protection
- Protective goggles
- If dust is generated: appropriate breathing protection
- ▶ Specify and provide personal protective equipment for the particular job.
- ▶ Use only personal protective equipment which is in proper condition and offers effective protection.
- ▶ Adjust personal protective equipment to the person, for example the size.
- ▶ Remove unsuitable clothing and jewellery (e.g. rings, necklaces) and cover long hair with a hairnet.

2.4.13 Safety sign on the machine

Safety labels on the machine warn of hazards at danger points and are an important component of the machine's safety equipment. Missing safety labels increase the risk of serious and fatal injuries.

- ▶ Clean dirty safety labels.
- ▶ Each time after cleaning, check to ensure that the safety labels are complete and legible.
- ▶ Immediately replace missing, damaged and unrecognisable safety labels.
- ▶ Label spare parts with the required safety labels.

Descriptions, explanations and order numbers of the safety labels, [see Page 30](#).

2.4.14 Road safety

Dangers during road travel

Other road users can be put at risk when you drive on public roads and the machine is not properly illuminated and/or exceeds the maximum dimensions and weights laid down by national law.

- ▶ Prior to driving on public roads, ensure that the maximum permissible dimensions, weights and axle, support and trailer loads are not exceeded which are applicable under national law for driving on public roads.
- ▶ Before driving on roads, switch on the road travel lighting and ensure that it functions properly.
- ▶ Before driving on roads, close all stop cocks for the hydraulic supply to the machine between tractor and machine.
- ▶ Before driving on roads, move the tractor control units to the neutral position and lock them.

Danger when driving on road and field

Hitched and mounted machines change the handling characteristics of the tractor. The handling characteristics depend for instance on operating state and ground. If changed handling characteristics are not considered, the driver may cause accidents.

- ▶ Observe measures for driving on road and field, [see Page 192](#).

Dangers if the machine is not prepared properly for road travel

If the machine is not prepared properly for road travel, serious accidents may occur with traffic.

- ▶ Before driving on roads, prepare the machine for road travel, [see Page 193](#).

Danger when cornering with a machine hitched and due to the overall width

Accidents may occur when cornering due to the machine swinging out and also due to the overall width.

- ▶ Consider the overall width of the combined tractor and machine.
- ▶ Consider the larger swivel range when cornering.
- ▶ Adjust the driving speed when cornering.
- ▶ When turning, watch out for people, oncoming traffic and obstacles.

Dangers when operating the machine on slopes

The machine may tilt when it is used on slopes. As a result, accidents may occur and people may be seriously injured or killed.

- ▶ Do not work and drive on a slope unless the ground of the slope is flat and the adhesion of the tyres to the ground is ensured.
- ▶ Turn the machine at low speed. Turn in a large arc.
- ▶ Avoid driving across a slope because the centre of gravity of the machine will be changed by payload and by executing machine functions.
- ▶ Avoid abrupt steering movements on slopes.
- ▶ On slopes always deposit a round bale in such a way that it cannot move on its own.
- ▶ Do not park the machine on slopes.

Fire hazard

Frequent braking when driving on public roads, for example when driving downhill, can cause the brake to produce more heat.

Dust, contamination and crop residues can ignite on the hot surfaces of the brake. People can be seriously injured or killed by the fire.

- ▶ Prevent excessive heat from building up on the brake by driving with foresight in road traffic.
- ▶ Check and clean the machine in the brake area at regular intervals during the working day.

2.4.15 Parking the machine safely

An incorrectly parked and insufficiently safeguarded machine can represent a danger for people, especially children, and can be set into motion or fall over in an uncontrolled manner. People may be injured or killed.

- ▶ Park the machine on a horizontal and level ground capable of bearing the load.
- ▶ Before adjusting, repairing, servicing and cleaning the machine, ensure that it is securely positioned.
- ▶ Observe section "Parking the Machine" in chapter Driving and Transport. [see Page 193](#)
- ▶ Before parking: Shut down and safeguard the machine, [see Page 28](#).

2.4.16 Consumables

Unsuitable consumables

Consumables which do not comply with the requirements of the manufacturer may impair the operational safety of the machine and cause accidents.

- ▶ Use only consumables which comply with the requirements of the manufacturer.

For requirements on consumables, [see Page 52](#).

Contamination of hydraulic system and/or fuel system

Foreign objects and/or liquids in the hydraulic system and/or fuel system may impair the operational safety of the machine and cause accidents.

- ▶ Clean all connections and components.
- ▶ Close open connections by means of protective caps.

Environmental protection and disposal

Consumables such as diesel fuel, brake fluid, antifreeze and lubricants (e.g. gearbox oil, hydraulic oil) may damage the environment and the health of people.

- ▶ Do not release consumables into the environment.
- ▶ Fill consumables in a liquid-tight labelled container and dispose of according to the official regulations.
- ▶ Absorb leaked consumables with an absorbent material, fill them in a liquid-tight labelled container and dispose of according to the official regulations.

2.4.17 Dangers arising from environment

Fire hazard

Combustible materials may accumulate in the machine due to operation or animals, such as rodents or nesting birds, or dust resuspension.

In case of dry usage conditions, dust, impurities and crop residue may ignite on hot parts and the resulting fire may seriously injure or kill people.

- ▶ Check and clean the machine every day before using it for the first time.
- ▶ Check and clean the machine regularly during the working day.

Life-threatening electric shock from overhead lines

With tailgate open, the machine may reach the height of overhead lines. This may cause voltage to flash over to the machine and cause a fatal electric shock or fire.

- ▶ Keep a safe distance from electric overhead lines when opening the tailgate.
- ▶ Never open the tailgate near pylons and overhead lines.
- ▶ Keep a safe distance from electric overhead lines when the tailgate is open.
- ▶ To avoid a potential electric shock caused by a voltage flashover, never exit from or climb into the tractor under overhead lines.

Behavior in the case of voltage flashover of overhead lines

High electric voltage may be applied to electrically conducting parts of the machine due to voltage flashover. In case of voltage flashover, a voltage drop where major voltage differences are present is created on the ground around the machine. Due to major voltage differences in the ground, people may be killed by electric shocks when making big steps, laying on the ground or supporting themselves with their hands.

- ▶ Do not leave the cabin.
- ▶ Do not touch any metal parts.
- ▶ Do not establish any conductive connection to the ground.
- ▶ Warn people: Do not approach the machine. Electrical voltage differences on the ground may lead to severe electric shocks.
- ▶ Wait for help from professional rescue teams. The overhead line must be switched off.

If people have to leave the cabin despite the voltage flashover, for example because there is an imminent danger to life due to fire:

- ▶ Avoid simultaneous contact with machine and ground.
- ▶ Jump away from the machine. Jump into a safe standing position. Do not touch the machine from the outside.
- ▶ Move away from the machine in very small steps keeping your feet close together.

2.4.18 Sources of danger on the machine

Noise may damage your health

The noise development of the machine during operation may cause health damage such as hardness of hearing, deafness or tinnitus. When using the machine at high rotational speed, the noise level also increases. The height of the sound pressure level depends mainly on the tractor used. The emissions value was measured with the cabin closed under conditions according to DIN EN ISO 4254-1, Appendix B, [see Page 50](#).

- ▶ Before starting up the machine, estimate the risk caused by noise.
- ▶ Depending on the ambient conditions, working hours and the working and operating conditions of the machine, specify and use suitable hearing protection.
- ▶ Specify rules for the use of hearing protection and for the working time.
- ▶ During operation keep windows and doors of the cabin closed.
- ▶ Remove hearing protection for road travel.

Liquids under high pressure

The following liquids are under high pressure:

- Hydraulic oil

Liquids escaping under high pressure may penetrate through the skin and cause severe injuries.

- ▶ Shut down and safeguard the machine and contact qualified specialist workshop upon suspicion of damaged hydraulic system.
- ▶ Never search for leaks with bare hands. Even a very pin-sized hole may lead to serious injuries.
- ▶ When searching for leaks, use suitable aids, e.g. a piece of cardboard to avoid injuries.
- ▶ Keep body and face away from leaks.
- ▶ If liquids penetrate the body, immediately consult a doctor. The liquid must be removed from the body as quickly as possible.

Hot liquids

Persons can suffer burns and/or scalding when hot liquids are drained.

- ▶ Wear personal protective equipment when hot consumables are drained.
- ▶ If necessary, allow liquids and machine parts to cool down before you start repair, maintenance and cleaning work.

Damaged compressor unit

Damaged compressed-air hoses of compressor unit can tear off. Hoses moving in an uncontrolled manner can cause severe injuries.

- ▶ Contact a specialist workshop immediately if you suspect that the compressor unit is damaged.
- ▶ Shut down and safeguard the machine, [see Page 28](#).

Damaged hydraulic hoses

Damaged hydraulic hoses may tear off, burst or cause oil leaks. As a result, the machine may be damaged and people may be seriously injured.

- ▶ Shut down and safeguard the machine, [see Page 28](#).
- ▶ If it is suspected that hydraulic hoses are damaged, immediately contact a service centre, [see Page 242](#).

Hot surfaces

The following components may become hot during operation and may burn people:

- Bale chamber
- Magnetic coils of the regulating valves
- Gearbox
- ▶ Maintain an adequate distance from hot surfaces and adjacent components.
- ▶ Leave machine parts to cool down and wear protective gloves.

2.4.19 Dangers in connection with certain activities: Working on the machine

Only perform work when the machine is at standstill

If the machine is not shut down and safeguarded, parts may move unintentionally or the machine may start moving. Thus there is a risk of serious injuries or death.

- ▶ Before carrying out any repair, maintenance and cleaning work on the machine, shutdown and safeguard it, [see Page 28](#).

Maintenance and repair work

Improper maintenance and repair work endanger operational safety. Thus there is a risk of accidents, serious injuries or death.

- ▶ Only perform work which is described in this operating instructions. Prior to any work, stop and safeguard the machine, [see Page 28](#).
- ▶ All other maintenance and repair work must only be performed by qualified specialist workshop.

Working at or on heights of the machine

There is a risk of falling when working at or on heights of the machine. As a result, accidents may occur and people may be seriously or fatally injured.

- ▶ Prior to any work, stop and safeguard the machine, [see Page 28](#).
- ▶ Make sure you stand securely.
- ▶ Use a suitable fall protection.
- ▶ Secure the area below the assembly point against falling objects.

Raised machine and machine parts

The raised machine and machine parts may fall or tilt unintentionally. People may be seriously injured or killed, as a result.

- ▶ Do not stay under the raised machine or machine parts which are not safely supported, [see Page 29](#).
- ▶ Prior to all work on raised machines or machine parts, lower the machine or machine parts.
- ▶ Before performing any work under raised machines or machine parts, secure the machine or machine parts with rigid safety support or with hydraulic shut-off device or by supporting against lowering.

Danger associated with welding work

Improper welding work will endanger the operational safety of the machine. As a result, accidents may occur and people may be seriously or fatally injured.

- ▶ Never perform welding work on the following components:
 - Gearbox
 - Components of the hydraulics
 - Components of the electronics
 - Frame or supporting components
 - Running gear
- ▶ Before carrying out welding work on the machine, obtain consent by KRONE customer service and, if required, identify alternatives.
- ▶ Before performing welding work on the machine, park the machine safely and disconnect it from the tractor.
- ▶ Welding work must only be performed by experienced qualified personnel.
- ▶ Attach the earthing of the welding device near the welding points.
- ▶ Caution when performing welding work near electric and hydraulic parts, plastic parts and pressure accumulators. The parts may be damaged, endanger people or cause accidents.

2.4.20 Dangers in connection with certain activities: working on wheels and tyres

Improper assembly or disassembly of wheels and tyres will endanger the operational safety. As a result, accidents may occur and people may be seriously injured or killed.

The fitting of wheels and tyres requires adequate knowledge and approved mounting tools.

- ▶ If there is a lack of knowledge, have the wheels and tyres fitted by the KRONE dealer or by a qualified tyre service.
- ▶ When fitting tyres on the rims, never exceed the maximum permitted pressure specified by KRONE, otherwise the tyre or even the rim may explode, [see Page 50](#).
- ▶ When mounting the wheels, mount the wheel nuts with the specified tightening torque, [see Page 218](#).

2.4.21 Behaviour in dangerous situations and in case of accidents

Any measures not taken or incorrect measures in dangerous situations can make it difficult or impossible to rescue exposed persons. Due to the impeded conditions of rescue, the chances to help and heal injured people deteriorate.

- ▶ As a matter of principle: Park the machine.
- ▶ Get an overview of the existing danger and identify the reason.
- ▶ Secure the accident site.
- ▶ Save persons from the danger zone.
- ▶ Leave danger zone and do not enter it again.
- ▶ Alarm rescue workers and seek help, if possible.
- ▶ Carry out immediate lifesaving actions.

2.5 Safety routines

2.5.1 Shutting down and safeguarding the machine

 **WARNING**

Risk of injury due to movement of the machine or machine parts

If the machine has not been shut down, machine or machine parts may move unintentionally. As a result, people may be seriously injured or killed.

- ▶ Before leaving the operating position: Shut down and safeguard the machine.

To shut down and safeguard the machine:

- ▶ Park the machine on a stable, horizontal and level ground.
- ▶ Switch off the drives and wait until coasting parts have come to a complete stop.
- ▶ Switch off the tractor engine, remove the ignition key and take it with you.
- ▶ Secure the tractor against rolling away.
- ▶ Secure the machine against rolling away by using wheel chocks.
- ▶ If fitted, apply the parking brake on the machine.

2.5.2 Securing raised machine and machine parts against lowering

 **WARNING**

Crushing hazard due to movement of machine or machine parts

If the machine or machine parts are not secured against lowering, the machine or machine parts may roll, fall or sag. Thus people could be squeezed or killed.

- ▶ Lower the raised machine parts.
- ▶ Shut down and safeguard the machine, [see Page 28](#).
- ▶ Before working on or under raised machine parts: Secure machine or machine parts against lowering by means of hydraulic shut-off device (e.g. stop cock) on machine side.
- ▶ Before working on or under raised machine parts: Safely support machine or machine parts.

In order to safely support the machine or machine parts:

- ▶ To support, only use suitable and sufficiently dimensioned materials that do not break or yield.
- ▶ Bricks and hollow blocks are not suitable for safely supporting the machine and machine parts. Therefore they must not be used.
- ▶ Car jacks are also not suitable for safely supporting the machine and machine parts. They must not be used, as well.

2.5.3 Carrying out oil level check and oil and filter element changes safely

 **WARNING**

Safely checking the oil level and changing oil and filter element

The operational safety of the machine can be impaired if oil level check and oil and filter element changes are not carried out safely. This can lead to accidents.

- ▶ Safely check the oil level and change oil and filter element.

To check the oil level and change oil and filter element safely:

- ▶ Lower raised machine parts or secure them against falling down, [see Page 29](#).
- ▶ Shut down and safeguard the machine, [see Page 28](#).
- ▶ Observe the intervals for oil level check, oil and filter element changes, [see Page 207](#).
- ▶ Use only the oil grades/oil quantities specified in the consumables table, [see Page 52](#).
- ▶ Ensure that the oil and the equipment for filling are clean.
- ▶ Clean the area around the components (for example gearbox, high-pressure filter) and make sure that no foreign objects get into the components or the hydraulic system.
- ▶ Check installed seal rings for damage. Replace them if necessary.
- ▶ Collect leaking oil and/or waste oil in a container provided for this purpose, and dispose of it properly, [see Page 24](#).

2.5.4 Running actuator test

 **WARNING**

Run actuator test safely

When actuators are energised, functions are carried out directly and without a safety prompt. This may cause the unintentional movement of machine parts, trapping and seriously or fatally injuring persons.

- ✓ Only persons familiar with the machine are permitted to perform the actuator test.
- ✓ The person performing the test must know which machine parts are activated by controlling the actuators.
- ▶ Run the actuator test safely.

To run the actuator test safely:

- ▶ Lower raised machine parts or secure them against falling, [see Page 29](#).
- ▶ Shut down and secure the machine, [see Page 28](#).
- ▶ Cordon off the danger zone of the actuated moving machine parts in a clearly visible manner.
- ▶ Ensure that there is nobody in the danger zone of the actuated moving machine parts.
- ▶ Switch on the ignition.
- ▶ The actuator test must only be performed from a safe position outside the area that is affected by machine parts moved by the actuators.

2.6 Safety sign on the machine

Each safety sign is provided with an order number and can be ordered directly from the KRONE dealer. Immediately replace missing, damaged and unrecognisable safety signs.

When attaching safety signs, the contact surface on the machine must be clean and free of dirt, oil and grease to ensure optimum adhesion of the safety signs.

Location and meaning of the safety signs

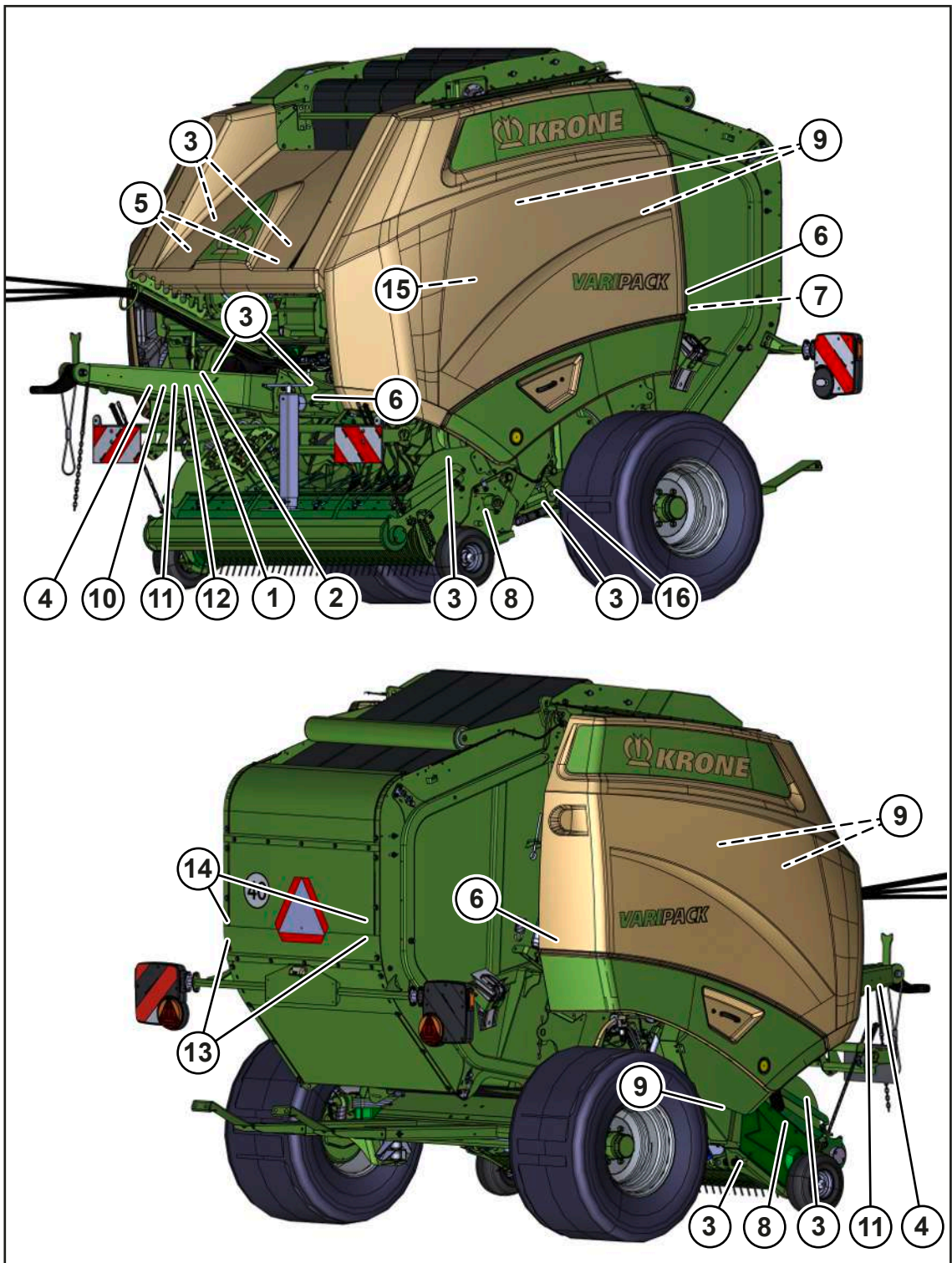

RPG000-165

1. Ord. no. 939 471 1 (1x)

	<p>Danger due to incorrect operation and lack of knowledge</p> <p>Incorrect operation and lack of knowledge of the machine as well as incorrect behaviour in hazardous situations is risking the life of the operator and third parties.</p> <ul style="list-style-type: none"> ▶ Before starting up the machine, read and follow the operating instructions and safety instructions.
--	---

2. Order no. 939 100 4 (1x) without "gearbox 1000 rpm" version

Order no. 939 101 4 (1x) with "gearbox 1000 rpm" version

	<p>Danger when exceeding the maximum permissible PTO speed or the maximum permissible operating pressure</p> <p>When exceeding the permissible PTO speed, machine parts may be destroyed or ejected.</p> <p>If the maximum permissible operating pressure is exceeded, hydraulic parts may be damaged.</p> <p>As a result, people may be seriously or fatally injured.</p> <ul style="list-style-type: none"> ▶ Observe the permissible PTO speed. ▶ Observe the permitted operating pressure.
--	---

3. Ord. no. 942 196 1 (8x)

	<p>Danger due to crushing or shearing</p> <p>Risk of injury due to crushing or shearing points on moving machine parts.</p> <ul style="list-style-type: none"> ▶ While parts are moving, never reach into areas where there is a risk of being crushed.
--	---

4. Ord. no. 939 407 1 (2x)

	<p>Danger due to rotating pick-up</p> <p>There is a danger of being drawn in if you approach the danger zone and if you use your hands or feet to remove crop blockages.</p> <ul style="list-style-type: none"> ▶ Before working on the pick-up, switch off the PTO shaft and the engine.
--	---

5. Ord. no. 939 125 1 (2x)

	<p>Danger from sharp blades</p> <p>There is danger of being cut when reaching into the danger zone of the blades.</p> <ul style="list-style-type: none"> ▶ Wear cut-resistant protective gloves.
---	--

6. Ord. no. 27 014 371 0 (3x)

	<p>Danger due to impact or crushing</p> <p>There is danger to life due to the tailgate lowering.</p> <ul style="list-style-type: none"> ▶ Before carrying out any maintenance work in the area of the tailgate, close the stop cock on the left lifting cylinder. ▶ Ensure that there is no one under the raised tailgate.
---	---

7. Order no. 942 290 0 (1x) for "support for fire extinguisher" version

	<p>Danger due to fire</p> <p>Risk of injury due to fire on the machine.</p> <ul style="list-style-type: none"> ▶ Do not operate the machine unless there is a functional fire extinguisher available.
--	---

8. Ord. no. 939 520 1 (2x)

	<p>Danger due to rotating auger</p> <p>There is a risk of being pulled in or caught by the rotating auger.</p> <ul style="list-style-type: none"> ▶ Never reach into the rotating auger. ▶ Maintain an adequate distance from moving machine parts.
---	--

9. Ord. no. 942 002 4 (5x)

	<p>Danger due to rotating machine parts</p> <p>When the machine is running, there is a risk of injury due to rotating machine parts.</p> <ul style="list-style-type: none"> ▶ Before starting up, move the guards into their protective position.
---	---

10. Ord. no. 942 360 4 (1x)



Danger due to unintended movement of the machine when opening the tailgate

Risk of injury due to the machine rolling away or overturning.

- ▶ Before opening the tailgate, ensure that the machine has been correctly coupled to the tractor.
- ▶ When uncoupling the machine, ensure that the tailgate is closed.

11. Ord. no. 939 408 2 (2x)



Danger due to rotating machine parts

When climbing onto the machine while the PTO shaft is running, there is a risk of being pulled in by rotating machine parts.

- ▶ Before climbing onto the machine, switch off the PTO shaft and the engine.

12. Ord. no. 27 028 023 0 (1x)



Danger due to electric shock

Life-threatening injuries due to voltage flashover if machine parts come too close to overhead lines.

- ▶ Maintain the prescribed safety distance from overhead power lines.

13. Ord. no. 27 013 422 0 (2x)



Danger due to impact

Risk of injury from the rolling bale.

- ▶ Ensure that no one remains in the danger zone.

14. Ord. no. 939 412 2 (2x)

	<p>Danger due to impact or crushing</p> <p>When opening the tailgate, there is a risk of people being crushed in the danger zone between the tailgate and a fixed obstacle.</p> <ul style="list-style-type: none"> ▶ Ensure that there is nobody between the tailgate and a fixed obstacle.
---	---

15. Order no. 27 018 010 0 (1x)

	<p>Danger due to high-pressure liquid</p> <p>Hydraulic pressure tanks contain pressurised oil and gas. Risk of injury due to incorrect removal of a pressure tank or improper repairs to the hydraulic system.</p> <ul style="list-style-type: none"> ▶ Removal of a pressure tank or repairs to a hydraulic system may be carried out by a service centre only.
---	--

16. Ord. no. 27 014 439 0 (1x)

	<p>Danger due to impact</p> <p>Risk of injury due to lever under spring tension.</p> <ul style="list-style-type: none"> ▶ When actuating the lever, maintain an adequate distance.
--	--

2.7 Information signs on the machine

Each information sign is provided with an order number and can be ordered directly from the KRONE dealer. Immediately replace missing, damaged and unrecognisable information signs.

When attaching information signs, the contact surface on the machine must be clean and free of dirt, oil and grease to ensure optimum adhesion of the information signs.

Location and meaning of the information signs

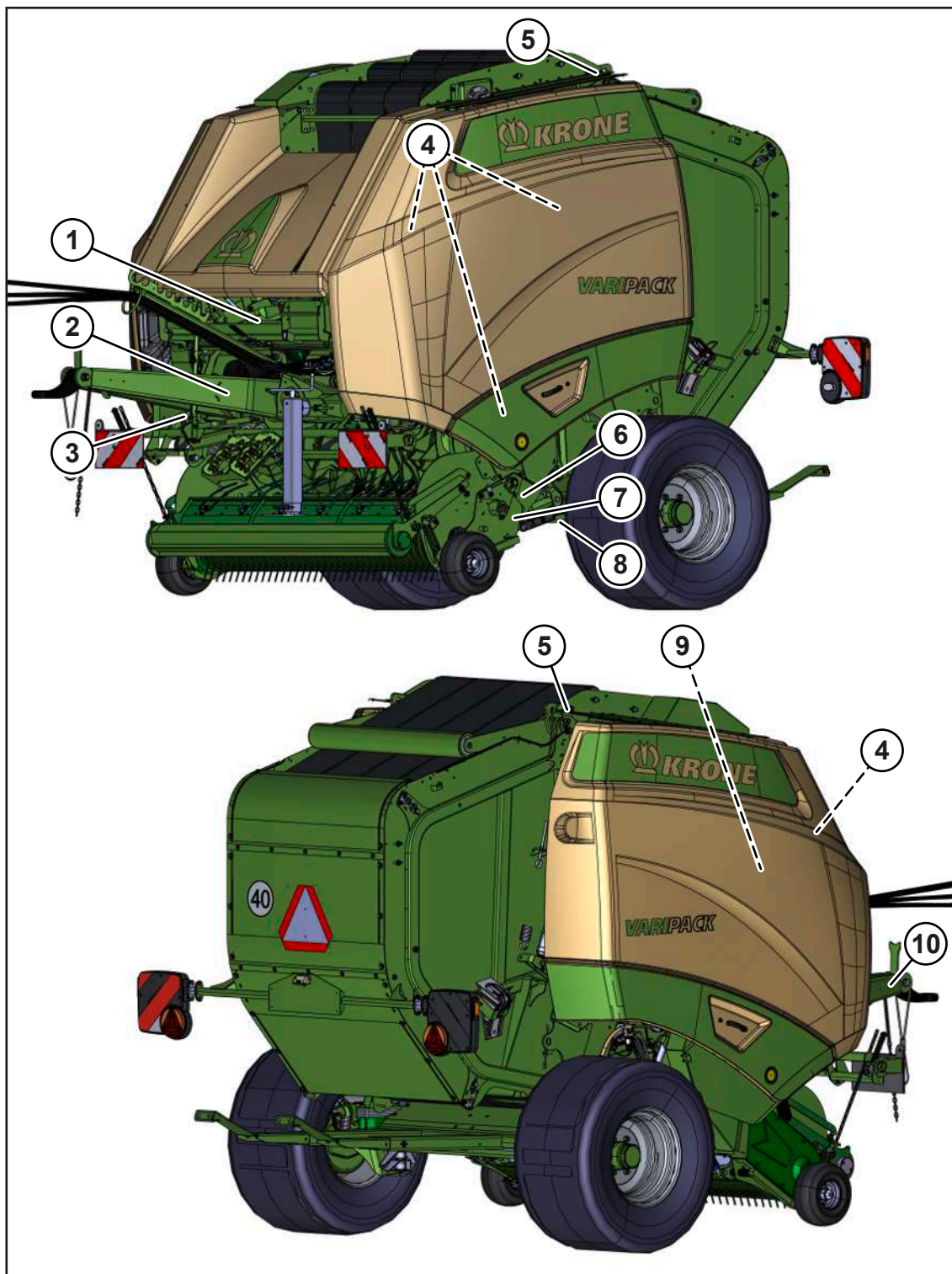

RPG000-231

1. Ord. no. 27 025 114 0 (1x)

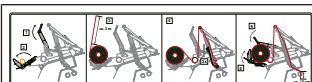

This shows how to load the net in the machine, [see Page 94](#).

2. Ord. no. 27 023 843 0 (1x)

	<p>These are the possible hydraulic connections of the machine. For additional information on connecting the hydraulic hoses, see Page 61.</p>
--	--

3. Ord. no. 27 028 145 0 (1x)

	<p>To obtain an evenly shaped round bale, tractor and machine should be guided over the swath as shown in the figure, see Page 77.</p>
--	--

4. Ord. no. 942 038 1 (4x)

	<p>The areas marked with this information sign must be protected from splash water. In particular, never direct the water jet of the high-pressure cleaner at bearings and electric/electronic components.</p>
--	--

5. Ord. no. 939 194 1 (2x)

	<p>Use a load beam when the machine is lifted, see Page 197.</p>
--	--

6. Ord. no. 27 029 221 0 (1x)

	<p>The contact pressure relief makes it easier to overcome unevenness of the ground. This contact pressure relief function can be activated or deactivated, see Page 85.</p>
--	--

7. Ord. no. 27 029 222 0 (1x)

	<p>The height of the drawbar has been optimally set when the distance between the centre of the cutting rotor or feed rotor is 835 mm for hay and 855 mm for straw when the machine is connected to the tractor, see Page 55.</p>
--	---

8. Ord. no. 27 005 758 0 (1x)

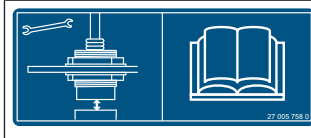

The sensor B08 "Blade cassette up" is installed here. If required, the sensor must be adjusted, [see Page 185](#).

9. Order no. 27 028 859 0 (1x) for "net wrapping and twine tying" version

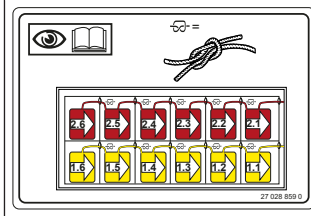

This shows how to insert and knot the spools of twine and the twine in the machine, [see Page 100](#).

10. Order no. 939 478 3 (1x) for "Drawbar eye top" version

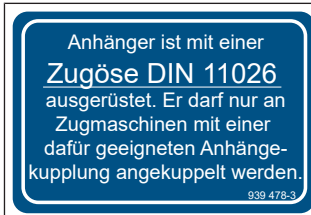

The trailer is equipped with a drawbar eye to DIN 11026. It may only be coupled to tractors with a suitable tow coupling.

- Ord. no. 27 021 260 0



There are several lubrication points on the machine which must be lubricated at regular intervals, [see Page 210](#). Lubrication points which are not directly visible are additionally marked with this information sign.

- Ord. no. 27 018 170 0



There are car jacking points on the machine which are marked by this information sign, [see Page 256](#).

- Order no. 942 012 2

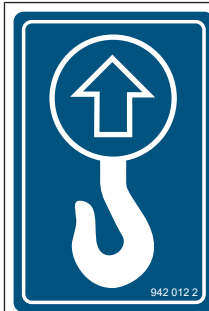

There are suspension points on the machine which are marked by this information sign, [see Page 197](#).

- Ord. no. 27 023 958 0

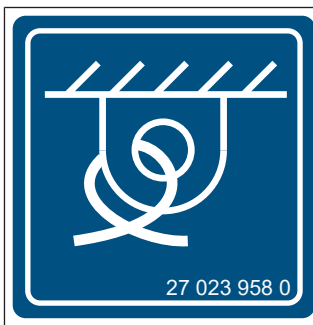

There are lashing points on the machine which are marked by this information sign, [see Page 198](#).

2.8 Safety equipment

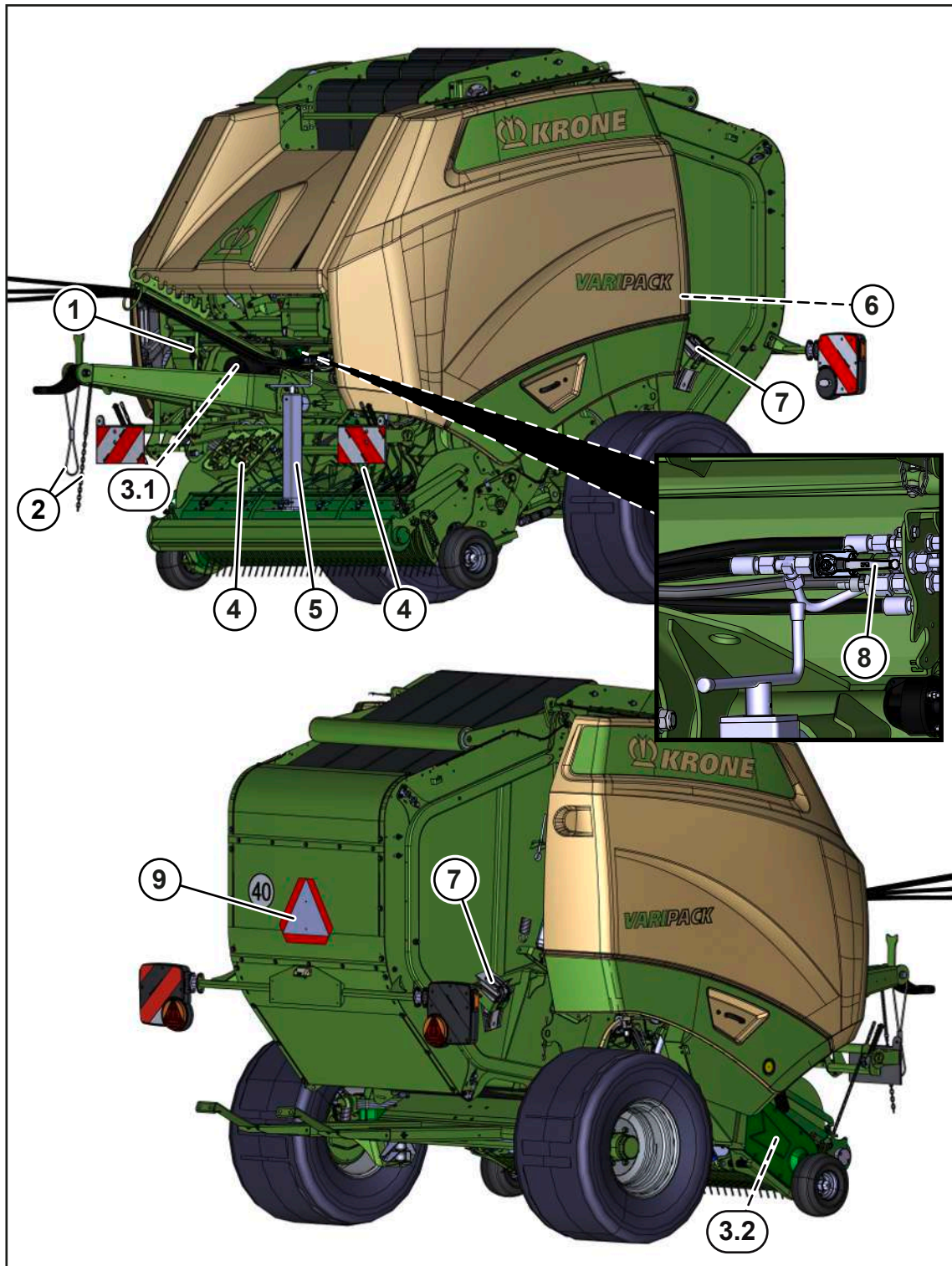

RPG000-158

Pos.	Designation	Explanation
1	Parking brake (country-specific)	<ul style="list-style-type: none"> • The parking brake is used to secure the machine from unintentionally rolling away, see Page 81. • The additional safety cable applies the parking brake if the machine breaks away from the tractor while it is driving, see Page 81. • In order to prevent the machine from rolling away, also use the wheel chocks, see Page 82.
2	Safety chain	<ul style="list-style-type: none"> • The safety chain is used for the additional protection of trailed machines in case they become unhitched during transport, see Page 64. • The country-specific regulations for using the safety chain during transportation of the machine must be observed.
	Catch loop	<ul style="list-style-type: none"> • The catch loop is used for the additional protection of hitched machines, see Page 65.
3.1	Overload protection universal shaft	<ul style="list-style-type: none"> • The overload protection guards the tractor and the machine from load peaks, see Page 45.
3.2	Pick-up overload protection	<ul style="list-style-type: none"> • The overload protection guards the tractor and the machine from load peaks, see Page 45.
4	Ladders for tying	<ul style="list-style-type: none"> • The ladders for the tying system are used to facilitate tying and to insert the net more easily, see Page 82.
5	Support jack	<ul style="list-style-type: none"> • The support jack is used to keep the machine stable when it is not connected to the tractor, see Page 79.
6	Fire extinguisher	<p>For "support for fire extinguisher" version</p> <ul style="list-style-type: none"> ▶ Register the fire extinguisher. <p>This is the only way of ensuring that due inspection intervals (every 2 years) are observed.</p> <ul style="list-style-type: none"> ▶ Observe country specifications. <p>The inspection intervals may differ from one country to another. If this is the case, follow the instructions on the fire extinguisher.</p> <p>Further information, see Page 228.</p>

Pos.	Designation	Explanation
7	Wheel chocks	<ul style="list-style-type: none"> The wheel chocks secure the machine against rolling away. 2 wheel chocks are affixed to the machine, see Page 82. To prevent the machine from rolling away, use the parking brake in addition to the wheel chocks, see Page 81.
8	Stop cock tailgate	<ul style="list-style-type: none"> The tailgate stop cock is a safety component which prevents the tailgate from unintentionally closing, see Page 105.
10 (depending on country version)	SMV emblem	<ul style="list-style-type: none"> The Slow-Moving Vehicle emblem may be attached to slow-moving machines or vehicles, see Page 42. The country-specific specifications must be observed. The SMV emblem is at the rear in the centre or on the left. If the machine is transported on transport vehicles (e.g. lorry or train), the SMV emblem must be covered or removed.

2.8.1 SMV emblem

For the version with “SMV emblem”

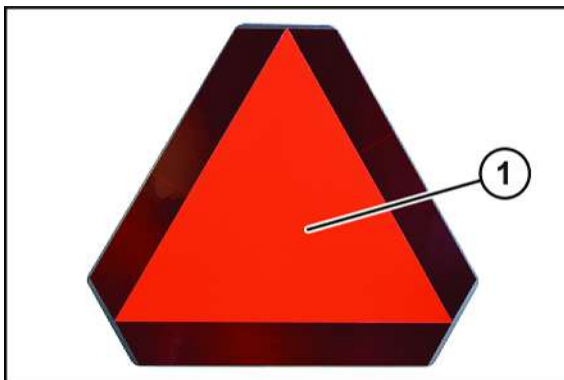

KM000-567

The SMV emblem (Slow-Moving Vehicle) (1) can be mounted on slow-moving machines or vehicles. The country-specific specifications must be observed.

The SMV emblem (1) is at the rear in the centre or on left.

If the machine is transported on transport vehicles (for example lorry or train), the SMV emblem must be covered or dismantled.

3 Data memory

A large number of electronic components of the machine contains data memories which save temporarily or permanently technical information on machine condition, events and errors. This technical information generally documents the condition of a part, a module, a system or the environment:

- Operating states of system components (e.g. filling levels)
- Status messages of the machine and its individual components (e.g. number of revolutions of wheel, wheel speed, motion delay, lateral acceleration)
- Malfunctions and defects in essential system components (e.g. light and brakes)
- Reactions of the machine in special driving situations (e.g. activation of the stability control systems)
- Ambient conditions (e.g. temperature).

This data, which is of an exclusively technical nature, is used to identify and eliminate faults and to optimise machine functions. The data cannot be used to generate movement profiles of travelled distances.

For service activities (e.g. repair services, service processes, warranty cases, quality assurance), employees of the service network (including manufacturer) can use special diagnostic units to read this technical information from the event and error data memories. If necessary, you can obtain further information there. After the error has been eliminated, the information in the error memory is either deleted or continuously overwritten.

When using the machine, situations are possible in which this technical data, in conjunction with other information (accident protocol, damage to the machine, witness statements etc.) - if necessary with the assistance of an expert - can be related to persons.

Additional functions, which are contractually agreed with the customer (e.g. teleservice), allow the transmission of certain machine data from the machine.

4 Machine description

4.1 Machine overview

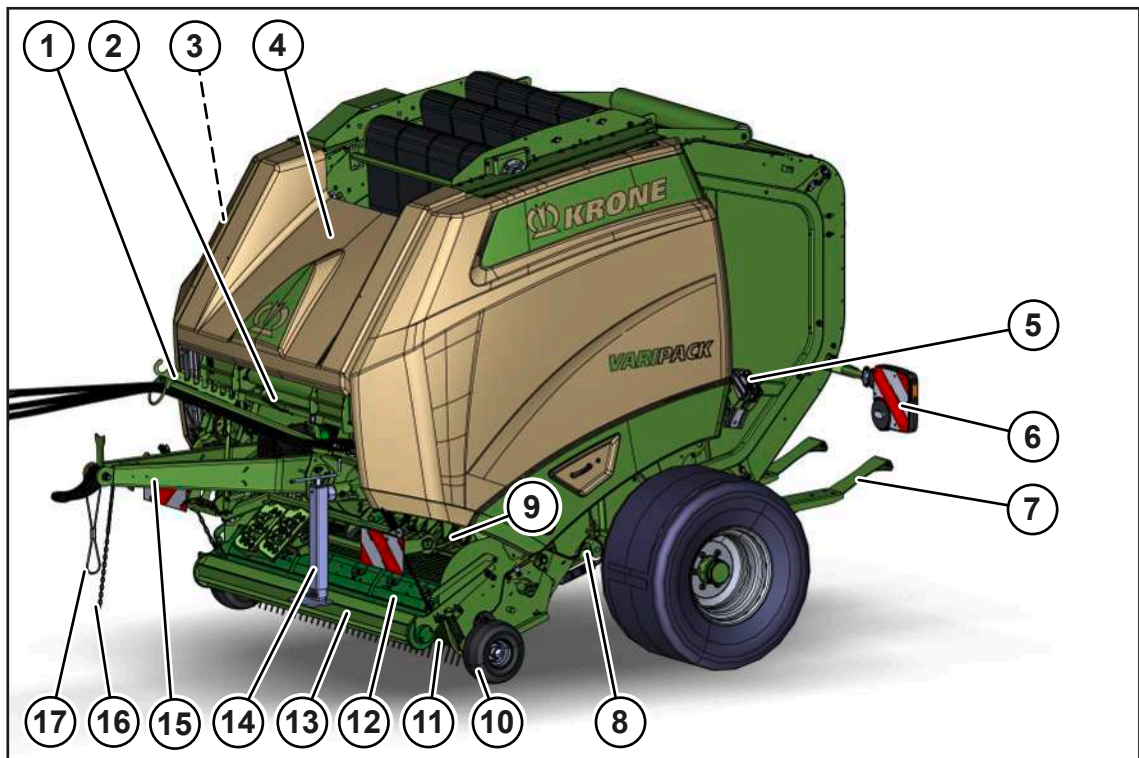

RPG000-168

- | | |
|---------------------------------------|--|
| 1 Hose and cable support | 10 Guide wheel |
| 2 Tying | 11 Pick-up |
| 3 Document storage tube | 12 Baffle sheet on the crop press roller unit |
| 4 Front hood | 13 Crop press roller unit |
| 5 Wheel chock (mounted on both sides) | 14 Support jack |
| 6 Road travel lighting | 15 Drawbar |
| 7 Bale ejector | 16 Safety chain (depending on country version) |
| 8 Blade cassette | 17 Lanyard (depending on country version) |
| 9 Integral cutting rotor | |

4.2 Overload protections on the machine

NOTICE

Machine damage due to load peaks

The overload protections protect the tractor and the machine from load peaks. For this reason, overload protections must not be modified. The warranty for the machine becomes void if other than the factory-specified overload protections are used.

- ▶ Only use the overload protections installed in the machine.
- ▶ To avoid early wear of the overload protection, switch the PTO shaft off if the overload protection responds for a longer period of time.
- ▶ Shut down and safeguard the machine, [see Page 28](#).
- ▶ Remedy the malfunction, [see Page 243](#).

The following components are protected by overload protections against damages.

Universal shaft

To prevent an overload, there is a cam clutch on the universal shaft. It is not necessary to bleed this cam clutch.

If the cam clutch is actuated due to a machine overload, [see Page 229](#).

Pick-up drive

To prevent an overload, there is a claw coupling on the pick-up drive. This claw coupling has been set at the factory and must not be adjusted without consulting your KRONE service partner.

4.3 Identification plate

INFO

The entire identification plate represents a legal document and should not be altered or rendered illegible!

Type plate

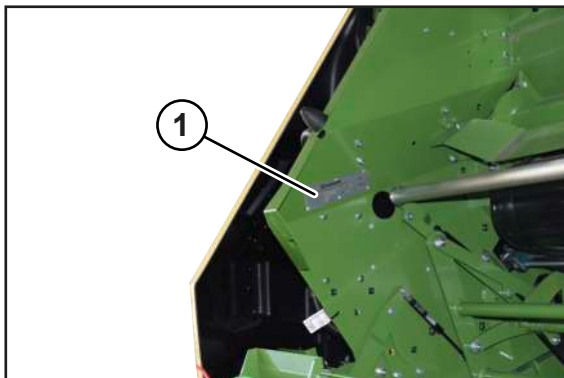

RPG000-007

The machine data is specified on a type plate (1). This is located on the right side of the machine under the front hood.

4 Machine description

4.4 Scope of delivery

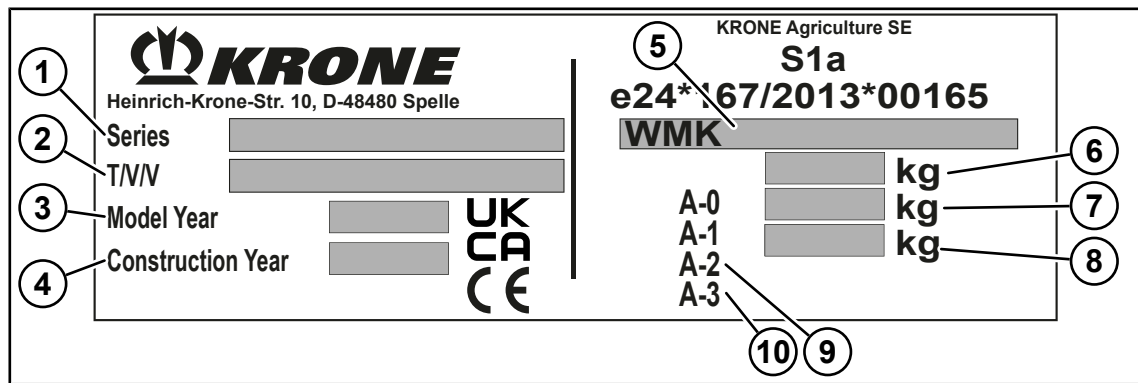

DVG000-004

Example image

- | | |
|---------------------------------|-------------------------------|
| 1 Series | 6 Total weight of the machine |
| 2 Type/variant/version (T/V/V) | 7 Drawbar load (A-0) |
| 3 Model year | 8 Axle load (A-1) |
| 4 Year of manufacture | 9 Axle load (A-2) |
| 5 Vehicle identification number | 10 Axle load (A-3) |

In case of queries about the machine and when ordering spare parts, ensure that you specify the series (1), the vehicle identification number (5) and the year of manufacture (4) of the corresponding machine. The machine number results from the last 7 digits of the vehicle identification number (5).

To ensure that the data is always available, KRONE recommends that you enter it in the boxes on the front cover of these operating instructions.

NOTE! To lift the machine, ensure that a hoist is used whose minimum load capacity depends on the permissible total weight of the machine. The minimum load capacity is the total weight of the machine (6) plus the drawbar load (7).

Location of the vehicle identification number

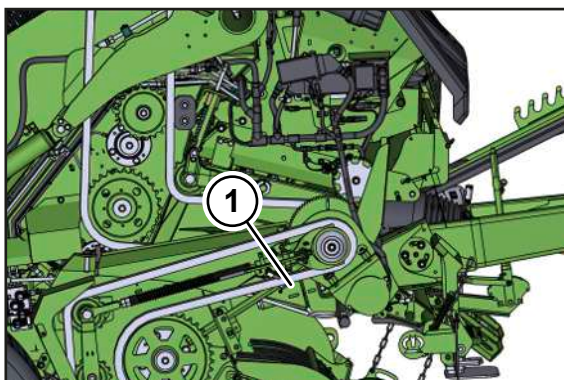

RPG000-253

In addition, the vehicle identification number (1) is embossed on the right-hand side of the machine.

4.4 Scope of delivery

The machine is delivered together with the following additional parts.

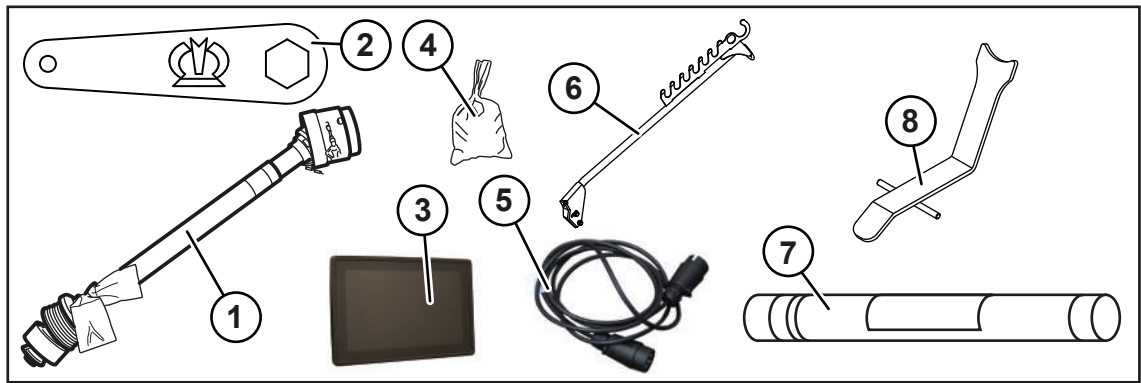

RPG000-056

- | | |
|-----------------------------------|--|
| 1 universal shaft | 5 7-pole connection cable for road travel lighting |
| 2 Ring spanner | 6 Hose and cable support |
| 3 Terminal (depending on version) | 7 Test roll KRONE excellent, net for net wrapping |
| 4 Small parts | 8 Universal shaft bracket |

4.5 Function description net wrapping

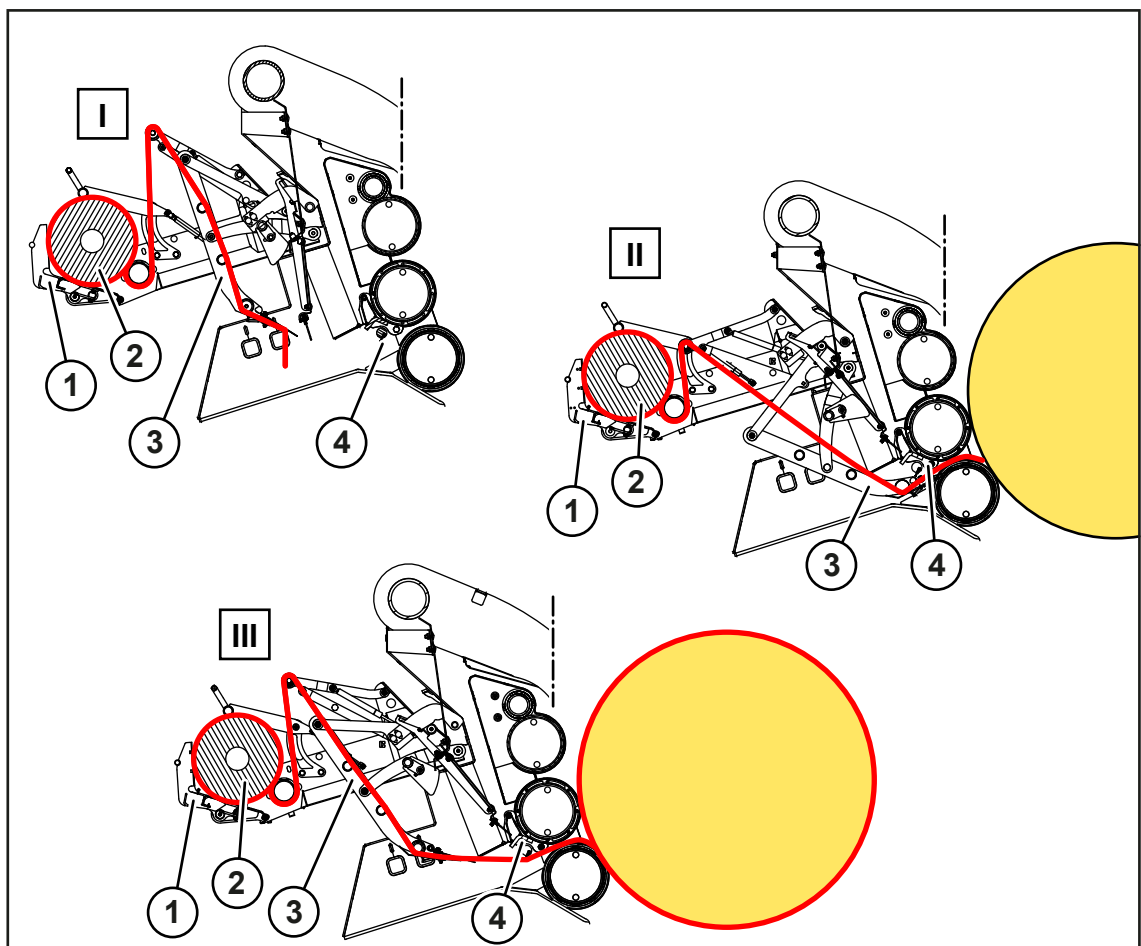

RP001-024

The net roll (2) lies in the net holder (1) and is inserted into the double wrapping unit. Here, the net path is shown in red.

(I) End position

The double wrapping unit is in the end position (I) when no round bale is wrapped. The feed rocker arm (3) is swung away from the bale chamber.

(II) Feed position

The tying cycle starts automatically or manually when the round bale is completely pressed in the bale chamber. The feed rocker arm (3) moves to the feed position (II) and guides the net to the round bale in the bale chamber. The bale chamber rollers guide the net to the round bale.

(III) Tying position

When the net is pulled, the double wrapping unit moves to the tying position (III) and continues to release net until the tying cycle with the selected number of net layers is completed. The double wrapping unit then moves back to the end position (I). This movement triggers the blade (4) to cut the net.

4.6 Function description of twine tying

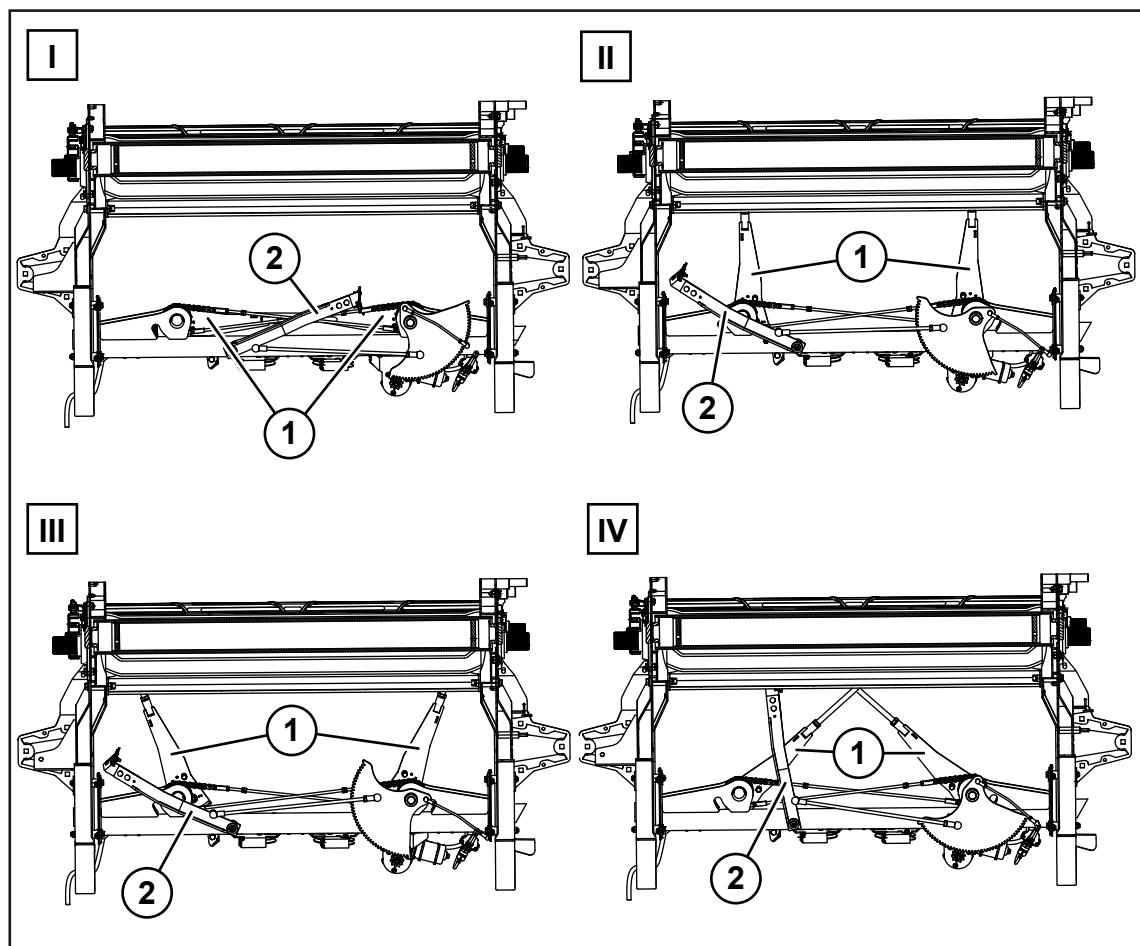

RP001-281

(I) Zero position

The double wrapping unit is in the zero position (I) when no round bale is wrapped. The twine arms (1) and the blade (2) are completely retracted.

(II) Feed position

The tying cycle starts automatically or manually when the round bale is completely pressed in the bale chamber. The twine arms (1) move to the bale chamber in feed position (II) such that the twine can be pulled off the round bale.

(III) Tying start position

When both twines are pulled, the twine arms (1) move to the previously stored tying start position (III) at the outer edge of the round bale. The tying cycle starts there with the selected number of twine layers.

(IV) End position

During the tying cycle, the twine arms (1) move from the outer edge to the centre of the round bale to the previously stored end position (IV). When the selected number of twine layers is reached, the twine arms move back to the zero position (I). At the same time, the blade (2) cuts both twines one by one in succession.

4.7 Function description cutting unit

The machine has a cutting unit with cutting rotor and fixed blades. Cutting helps to improve further processing of the round bales and to increase baling density. From the tractor, the blade cassette can be swivelled hydraulically out of the feed channel if there are any crop blockages, [see Page 88](#).

5 Technical data

5.1 Dimensions

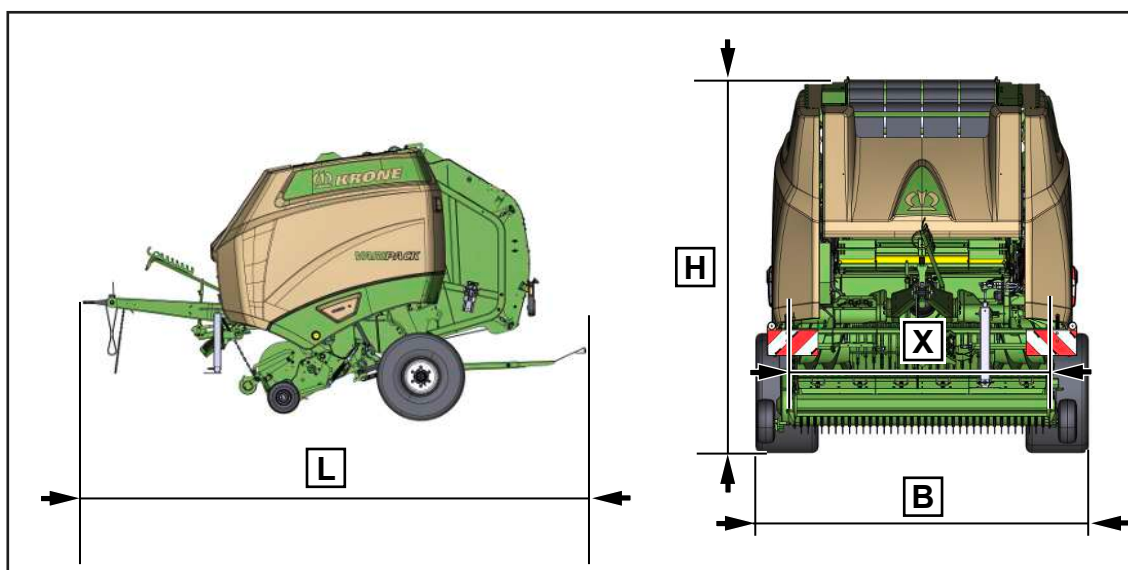

RPG000-229

Dimensions	
Width [W] depending on tyres	2,541–2,765 mm
Height [H] (with standard tyres)	2,940 mm
Length [L] (with bale ejector)	5,005 mm
Working width [X]	2,150 mm

5.2 Weights

Weights	
Weights	See information on the type plate, see Page 45 .

5.3 Technically permitted maximum speed (road travel)

The technically permitted maximum speed may be restricted by different equipment features (e.g. coupling device, axle, brake, tyres, etc.) or by statutory regulations in the country of use.

Technically permitted maximum speed (road travel)	
Technically permitted maximum speed (road travel)	40 km/h

5.4 Airborne noise emission

Airborne noise emission	
Emissions value (sound pressure level)	73.2 dB
Measurement device	Bruel & Kjaer, Type 2236
Accuracy class	2
Measurement uncertainty (according to DIN EN ISO 11201)	4 dB

5.5 Ambient temperature

Ambient temperature	
Temperature range for machine operation	-5 to +45 °C

5.6 Tyres

Tyre designation	Minimum pressure $V_{max}=10$ km/h	Maximum pressure	Recommended tyre pressure ¹
Guide wheels on the pick-up			
15x6.00-6		3.2 bars	1.5–2.0 bar
Tyres on the machine			
15.0/55-17 (standard tyres)	1.8 bar	2.6 bar	2.6 bar
500/50-17	1.5 bar	2.8 bar	2.0 bar
500/55-20	1.5 bar	3.0 bar	1.5 bar

¹ The recommendation applies in particular to the usual mixed operation (field/road) at the maximum permitted speed of the machine. If required, the tyre pressure can be reduced to the indicated minimum air pressure. However, the associated maximum speed must then be observed.

5.7 Safety chain

Safety chain	
Tensile strength	89 kN (20,000 lbf)

5.8 Bale dimensions

Bale dimensions	
Width	1,200 mm
Diameter	dia. 800-1650 mm

5.9 Twine wrapping and tying material

Twine wrapping and tying material	
Run length plastic twine	400–600 m/kg
Run length sisal	150–300 m/kg
Maximum diameter of the spool of twine	270 mm
Maximum height of the spool of twine	270 mm

5.10 Net wrapping and tying material

Net wrapping and tying material	
External diameter of the net roll	∅ max. 300 mm
Length of the sleeve	max. 1,320 mm
Recommended net width	1,230–1,250 mm

5.11 Requirements for tractor - power

Requirements for tractor - power	
Tractor power	66 kW (90 HP)
PTO speed (without version "Gearbox 1000 rpm")	540 rpm
PTO speed (for "Gearbox 1000 rpm" version)	1000 rpm
PTO shaft end	1 3/8"; Z=6

5.12 Tractor requirements – hydraulics

Tractor requirements – Hydraulics	
Volume flow of the hydraulic system	30 ... 60 L/min
Minimum operating pressure of the hydraulic system	150 bars
Maximum operating pressure of the hydraulic system	200 bar
Maximum hydraulic oil temperature	80°C
Hydraulic oil quality	Oil ISO VG 46
Hydraulic connection (T)/depressurised return in the tank	1x
Single-acting hydraulic connection	1x
Double-acting hydraulic connection	1x

5.13 Requirements for tractor – electrics

Requirements for tractor – electrics	
Road travel lighting	12 volt, 7-pin socket
DS 100 operation unit power supply	12 volt, 3-pin socket
DS 500 operation unit power supply	12 volt, 9-pin socket
CCI 800/CCI 1200 terminal power supply	12 volt, 9-pin socket
ISOBUS	12 volt, 9-pin socket

5.14 Requirements for tractor – brake system

Requirements for tractor – brake system	
Compressed-air connection for "compressed air brake" version	2x
Maximum operating pressure for "hydraulic brake" version	100 bars

5.15 Consumables

<i>NOTICE</i>
<p>Complying with change intervals for biooils</p> <p>To ensure high life expectancy of the machine, it is absolutely necessary to comply with change intervals for biooils due to the ageing of the oils.</p>

NOTICE
Machine damage due to mixing of oil

If oils, which have different specifications, are mixed with each other, the machine may be damaged.

- ▶ Never mix oils, which have different specifications, with each other.
- ▶ Contact your KRONE service partner before using an oil with a different specification after changing the oil.

Biodegradable consumables can be used on request.

5.15.1 Oils

Designation	Filling quantity	Specification
T-gearbox main drive	2.00 L	SAE 90 GL4
Central chain lubrication unit	8.00 L	SAE 10W-40

5.15.2 Lubricating greases

Designation	Filling quantity	Specification
Lubrication points (manual lubrication)	The filling quantity is as required. Lubricate the lubrication points until lubricating grease comes out of the bearing position. After lubricating, remove the grease coming out of the bearing position.	Lubricating grease as specified in DIN 51818 of NLGI class 2, Li soap with EP additives
Lubrication points on the ADR axle	The filling quantity is as required. Lubricate the lubrication points until lubricating grease comes out of the bearing position. After lubricating, remove the grease coming out of the bearing position.	Lubricating grease as specified in DIN 51825: KP 3 N-20.
Lubrication points on the BPW axle	The filling quantity is as required. Lubricate the lubrication points until lubricating grease comes out of the bearing position. After lubricating, remove the grease coming out of the bearing position.	BPW ECO-Li Plus

For a list of the lubrication points to be lubricated [see Page 210](#).

6 Initial operation

This chapter describes assembly and adjustment work on the machine which may be carried out by qualified technicians only. Here, the notice "Personnel qualification of technicians" applies, [see Page 17](#).

WARNING

Risk of injury or damage to the machine due to faulty initial operation

If the initial operation is carried out incorrectly or incompletely, the machine may present defects. As a result, people may be injured or killed or the machine may be damaged.

- ▶ Initial operation must only be carried out by authorised technicians.
- ▶ Read in full and observe the "Personnel qualification of technicians", [see Page 17](#).

WARNING

Risk of injury due to non-observance of relevant safety notices

If the relevant safety notices are not observed, persons may get seriously injured or killed.

- ▶ To avoid accidents, the basic safety instructions must be read and observed, [see Page 16](#).

WARNING

Risk of injury due to non-observance of safety instructions

If the relevant safety routines are not observed, persons may be seriously injured or killed.

- ▶ The safety routines must be read and observed to avoid accidents, [see Page 28](#).

6.1 Checklist for initial operation

- ✓ All screws and nuts are checked for tightness, and are tightened to the specified tightening torques, [see Page 215](#).
- ✓ All sensors have been checked for tight fit and tightened to the specified tightening torques. The location of the sensors is shown in the circuit diagram.
- ✓ The safety devices are mounted and checked for completeness and damage.
- ✓ The machine is fully lubricated, [see Page 210](#).
- ✓ The universal shaft is lubricated, [see Page 214](#).
- ✓ The hydraulic system has been checked for leaks.
- ✓ The tractor corresponds to the machine requirements, [see Page 50](#).
- ✓ The supplied operating instructions are in the document storage tube.
- ✓ The tyres have been checked and the tyre pressure is adjusted correctly, [see Page 218](#).
- ✓ **For the "Support for fire extinguisher" version:** The fire extinguisher is mounted.
- ✓ The drawbar height is adjusted, [see Page 55](#).
- ✓ The length of the universal shaft has been checked and adjusted, [see Page 58](#).
- ✓ The universal shaft is mounted, [see Page 57](#).
- ✓ The cable ties, which were mounted to secure the storage box flap and the side hood, were removed.

6.2 Scope of delivery

The machine is delivered together with the following additional parts.

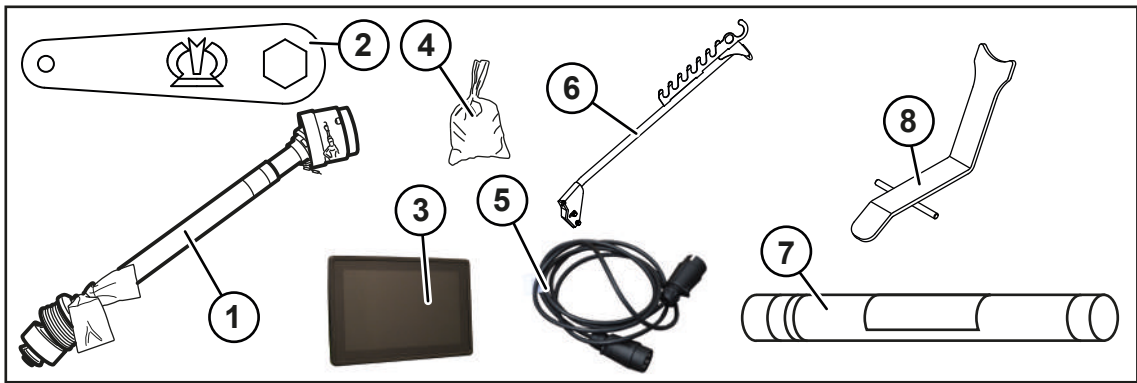

RPG000-056

- | | |
|-----------------------------------|--|
| 1 universal shaft | 5 7-pole connection cable for road travel lighting |
| 2 Ring spanner | 6 Hose and cable support |
| 3 Terminal (depending on version) | 7 Test roll KRONE excellent, net for net wrapping |
| 4 Small parts | 8 Universal shaft bracket |

6.3 Adjusting the drawbar height

NOTICE

When the tractor and machine are in a horizontal position, the hitched mechanical connection devices (e.g. ball-head hitch) must be in a horizontal position (+/- 3°) with respect to the ground so as not to obstruct the operational swivel angle between the mechanical connection devices.

To ensure that the pick-up evenly picks up the crops, the drawbar height of the machine must be adjusted to the tractor used.

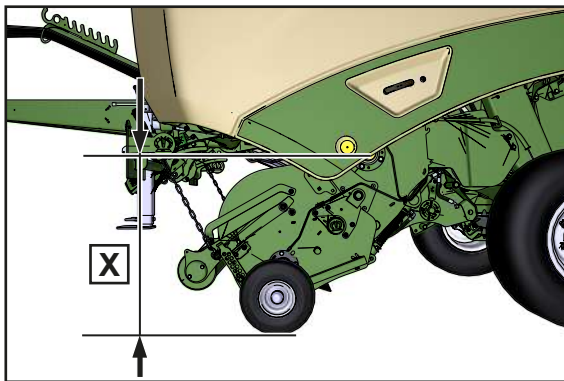

RPG000-058

The drawbar height adjustment is optimal when the distance X between the centre of the cutting rotor and the ground is **835 mm** when the machine is connected to the tractor.

The distance can be different for straw (large swaths): **X=855 mm**.

INFO

For high driving speeds on uneven terrain, KRONE recommends a **distance of X=855 mm**. If the machine is too low, there is no support pressure relief for the pick-up.

Checking drawbar height

- ✓ The tyre pressure matches the value in the tyre table, [see Page 51](#).
- ▶ To ensure optimum operating conditions, hitch the machine so that the dimension X matches the aforementioned values.
 - ⇒ If the measured dimension differs from dimension X, adjust the drawbar height as follows.

Adjusting the drawbar height

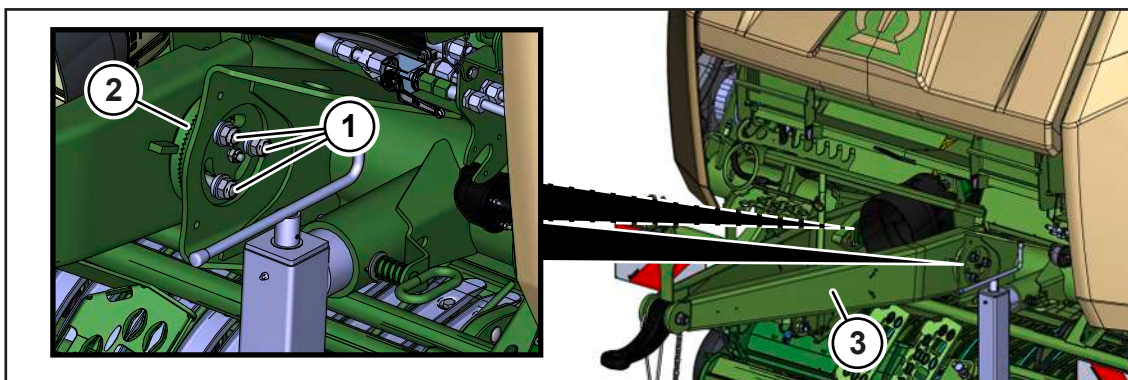

RPG000-087

- ✓ The machine is disconnected from the tractor and stands on the support jack.
- ▶ Loosen the screw connections (1) on the right and left sides of the drawbar until the drawbar (3) can be moved in the toothed disc connections (2).
- ▶ Adjust the drawbar (3) to the height of the tractor hitch.
- ▶ Ensure that the toothed disc connections (2) mesh.

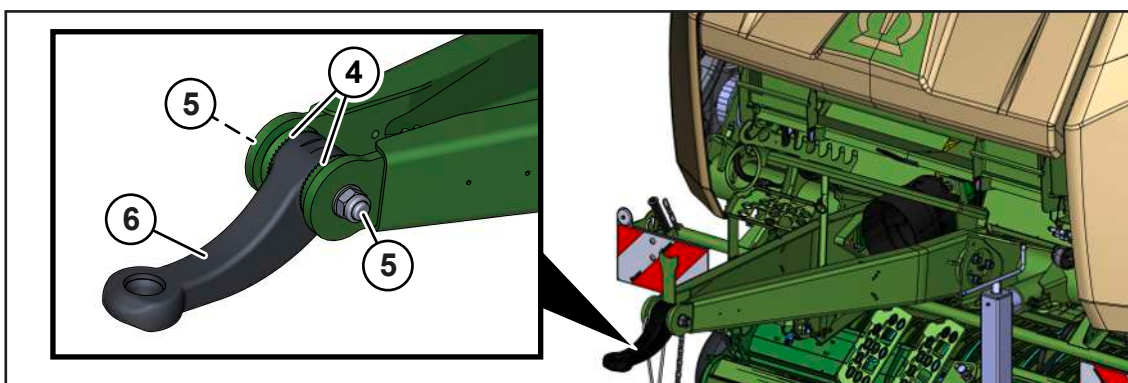

RPG000-136

To adjust the height of the drawbar eye (6):

- ▶ Loosen the screw connections (5) until the drawbar (6) can be moved in the toothed disc connections (4).
- ▶ Align the drawbar eye (6) parallel to the ground.
- ▶ Ensure that the toothed disc connections (4) mesh.
- ▶ Tighten the screw connections (1) and (5). Torque, [see Page 215](#).
- ▶ After 10 operating hours tighten the screw connections (1) and (5).

6.4 Universal shaft

6.4.1 Mounting the universal shaft on the machine

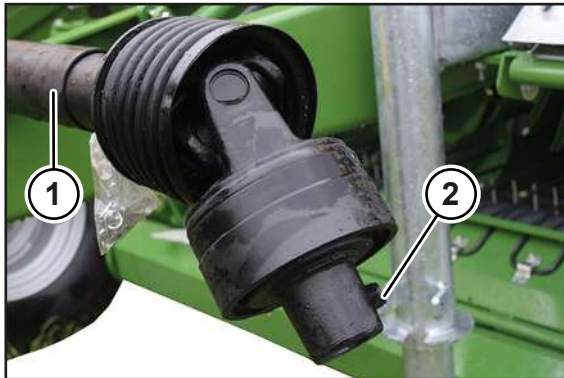

RP000-281

- ✓ The machine has been shut down and secured, [see Page 28](#).
- ✓ The length of the universal shaft is adjusted to the tractor, [see Page 58](#).
- ▶ Remove the screw connection (2) from the universal shaft (1).

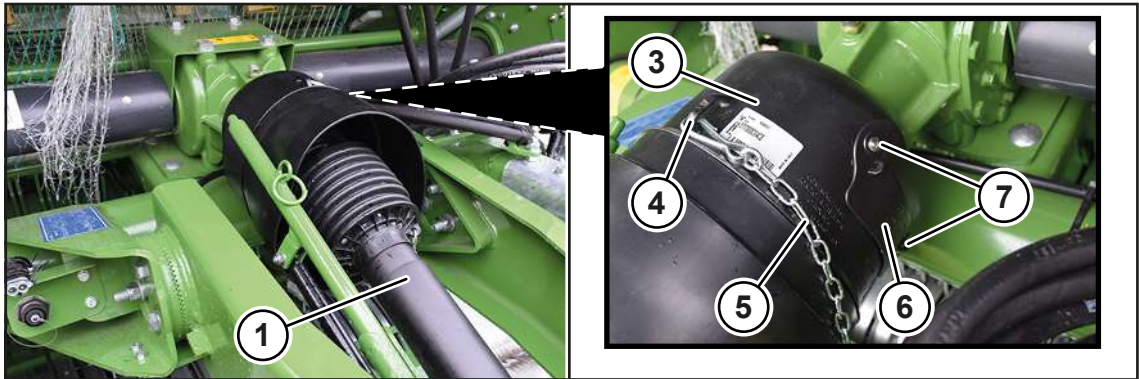

RPG000-179

- ▶ To facilitate access to the screw connection (2) on the universal shaft (1), remove the screw connections (7) and the cover (6) on the protective cap (3).
- ▶ Push the universal shaft (1) onto the PTO shaft end of the machine.
- ▶ Mount the screw connection (2) through the resulting hole behind the cover (6). The tightening torque is specified in the operating instructions provided with the universal shaft.
- ▶ Mount the cover (6).
- ▶ To prevent the supporting chain (5) from rotating, hook it into the eye (4) on the protective cap (3).

INFO

More details can be found in the operating instructions for the universal shaft.

6.4.2 Adjusting the length of the universal shaft

NOTICE

Changing the tractor

There is a risk of damaging the machine if the length of the universal shaft is not checked when the tractor is changed.

- ▶ To prevent damage to the machine, check the length of the universal shaft whenever you change tractors. Have it corrected by a KRONE service partner if necessary.

The universal shaft must be shortened as far as the narrowest position of both universal shaft halves permits.

To move the machine into the shortest position:

- ▶ Turn the steering of the tractor all the way to the left or to the right and move tractor and machine forwards until the narrowest position is reached when driving around curves.
- ▶ Switch off the engine and remove the ignition key and carry it with you.
- ▶ Secure machine and tractor against rolling away.
- ▶ Instructions on how to shorten the universal shaft can be found in the operating instructions of the universal shaft manufacturer.

6.4.3 Mounting universal shaft bracket

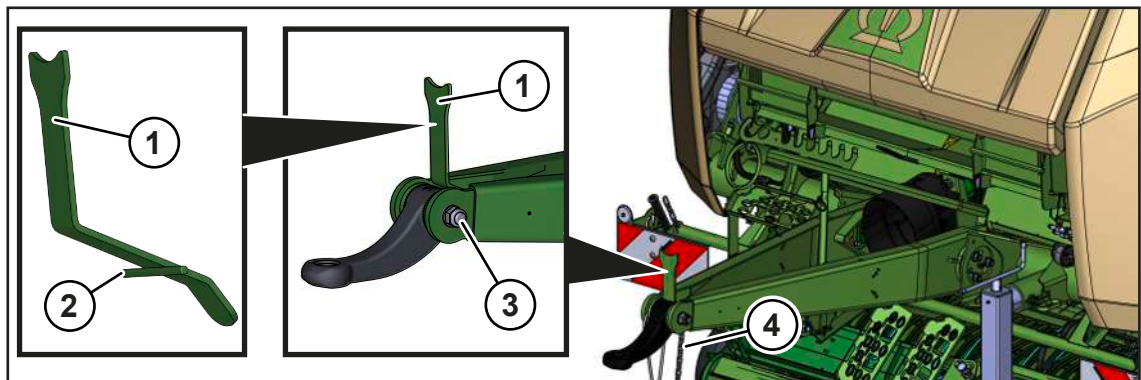

RPG000-133

The universal shaft bracket (1) is only required if the drawbar is in the bottom hitching.

The universal shaft bracket (1) is required to support the universal shaft when the machine has been uncoupled from the tractor.

- ✓ The machine has been shut down and secured, [see Page 28](#).
- ✓ The universal shaft chain (4) and the chain holder have been removed.
- ▶ To mount the universal shaft bracket (1), remove the screw connection (3).
- ▶ Clamp the ends of the bolt (2) on both sides in the boreholes in the drawbar beams.

NOTE! These are the boreholes of the universal shaft chain which was removed beforehand.

- ▶ Mount the screw connection (3). Torque: [see Page 215](#).
- ➔ The universal shaft can be deposited with the bottom hitching of the drawbar on the universal shaft bracket (1), [see Page 194](#).

7 Commissioning

 **WARNING**

Risk of injury due to non-observance of relevant safety notices

If the relevant safety notices are not observed, persons may get seriously injured or killed.

- ▶ To avoid accidents, the basic safety instructions must be read and observed, [see Page 16](#).

 **WARNING**

Risk of injury due to non-observance of safety instructions

If the relevant safety routines are not observed, persons may be seriously injured or killed.

- ▶ The safety routines must be read and observed to avoid accidents, [see Page 28](#).

 **WARNING**

Risk of injury or damage to the machine due to connection lines which have been incorrectly connected, interchanged or improperly installed

If the connection lines of the machine have been incorrectly connected to the tractor or have been improperly installed, they may pull off or be damaged. This may result in serious accidents. If connection lines are interchanged, functions may inadvertently be actuated which may also result in serious accidents.

- ▶ Correctly connect and secure the hoses and cables.
- ▶ Lay the hoses, cables and ropes so that they do not scrape, come under tension or become jammed or come into contact with other components (e.g. tractor tyres).
- ▶ Couple and connect the hoses and cables to the designated connections as described in the operating instructions.

7.1 Connecting machine to tractor

NOTICE

When the tractor and machine are in a horizontal position, the hitched mechanical connection devices (e.g. ball-head hitch) must be in a horizontal position (+/- 3°) with respect to the ground so as not to obstruct the operational swivel angle between the mechanical connection devices.

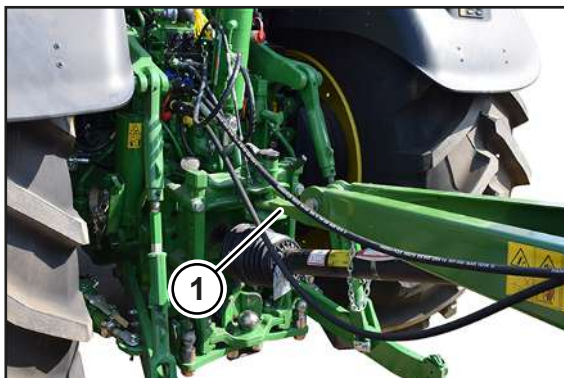

RP000-098

Example image

For version with "Drawbar eye"

WARNING! Increased risk of injury! Ensure that there is no one between the tractor and the machine while connecting the machine (especially while driving the tractor backwards).

- ▶ Reverse the tractor onto the drawbar until the drawbar eye of the machine has been inserted into the hitching device of the tractor.
- ▶ Shut down and safeguard the machine, [see Page 28](#).
- ▶ Secure the hitching device according to the operating instructions of the tractor manufacturer.

For version with "Ball drawbar eye"

WARNING! Increased risk of injury! Ensure that there is no one between the tractor and the machine while connecting the machine (especially while driving the tractor backwards).

- ▶ Drive the tractor backwards onto the drawbar and move the ball-head hitch of the tractor under the ball-head attachment of the machine.
- ▶ Lower the drawbar using the support jack until the ball-head drawbar eye is positioned on the ball-head attachment.
- ▶ Shut down and safeguard the machine, [see Page 28](#).
- ▶ Secure the hitching device according to the operating instructions of the tractor manufacturer.

7.2 Mounting the universal shaft on the tractor

WARNING

Risk of injury by failure to take account of the danger zone of the universal shaft

If the danger zone of the universal shaft is ignored, persons can be seriously hurt or killed.

- ▶ To avoid accidents, observe the danger zone of the universal shaft, [see Page 20](#).

NOTICE

Changing the tractor

There is a risk of damaging the machine if the length of the universal shaft is not checked when the tractor is changed.

- ▶ To prevent damage to the machine, check the length of the universal shaft whenever you change tractors. Have it corrected by a KRONE service partner if necessary.

- ✓ The machine has been shut down and secured, [see Page 28](#).

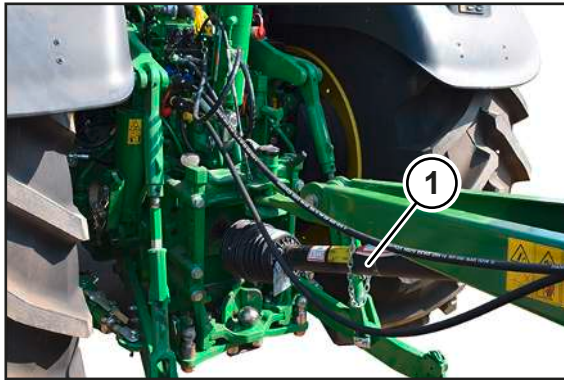

RPG000-096

- ▶ Push the universal shaft (1) onto the tractor PTO shaft and secure against turning by attaching the supporting chain in a suitable location.

7.3 Connecting hydraulic hoses

 **WARNING**

Risk of injury from escaping hydraulic oil

The hydraulic system operates at very high pressure. Escaping hydraulic oil may seriously injure skin, limbs and eyes.

- ▶ Prior to connecting the hydraulic hoses to the tractor, depressurise both sides of the hydraulic system.
- ▶ Depressurise the hydraulic system before you uncouple the hoses and work on the hydraulic system.
- ▶ When connecting the quick couplings, ensure that they are clean and dry.
- ▶ Check hydraulic hoses at regular intervals [see Page 242](#) and replace them if they are damaged (e.g chafing areas or points of contact) or aged. The replacement lines must comply with the technical requirements of the device manufacturer.

NOTICE

Damage to the machine due to soiling of the hydraulic system

If foreign objects or liquids get into the hydraulic system, the hydraulic system may be severely damaged.

- ▶ When connecting the quick couplings, ensure that they are clean and dry.
- ▶ Check the hydraulic hoses for abrasion and pinch point and replace if required.

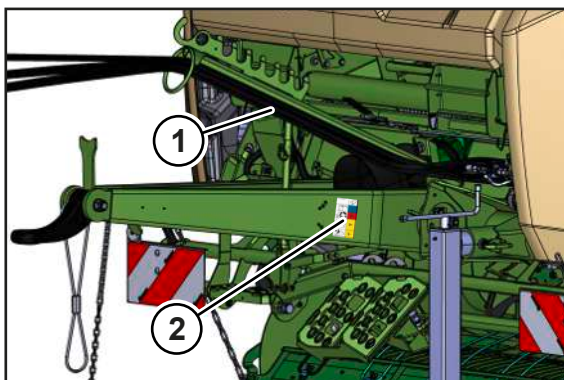

RPG000-117

Control units which can be locked in neutral position against unintentional operation must be used on the tractor.

To connect the hydraulic hoses (1) correctly, the hydraulic hoses (1) are marked with numbers.

Additional explanations of the markings on the handles can be found on the label (2) on the machine.

To connect the hydraulic hoses (1) and the other hydraulic connections correctly for Load Sensing, the hydraulic hoses (1) are marked with letters and coloured caps.

Additional explanations of the markings on the handles can be found on the label (2) on the machine.

- ▶ Depressurise the tractor hydraulics.
- ▶ Shut down and safeguard the machine, [see Page 28](#).
- ▶ Clean and dry the connections of the hydraulic quick connector.

Hydraulic connection for return to the tank

- ▶ Connect the hydraulic hose (blue, T) with the depressurised return on the tractor.

Opening/closing the hydraulic connection for the tailgate

- ▶ Connect the hydraulic hose (red, 1+) to a single-acting control unit of the tractor.

Lifting/lowering hydraulic connection for pick-up and for swivelling blades in/out and for lifting/lowering blade cassette

- ▶ Connect the hydraulic hoses (yellow, 3+, 3-) to a double-acting control unit of the tractor.

7.4 Connecting hydraulic brake (export)

A hydraulic brake may be required on the machine to meet country specific standards. A brake valve is required on the tractor for the hydraulic brake. The corresponding hydraulic hose is connected to the brake valve on the tractor. The brake is activated by actuating the brake pedal.

- ✓ The machine has been shut down and secured, [see Page 28](#).
- ▶ Connect the hydraulic hose of the hydraulic brake to the connection for the hydraulic brake on the tractor.

7.5 Connecting/disconnecting compressed air connections for the compressed air brake

The machine features a dual-line compressed air braking system. The coupling heads are connected to the machine for attachment of the supply line (2) (red coupling head) and brake line (1) (yellow coupling head) of the tractor.

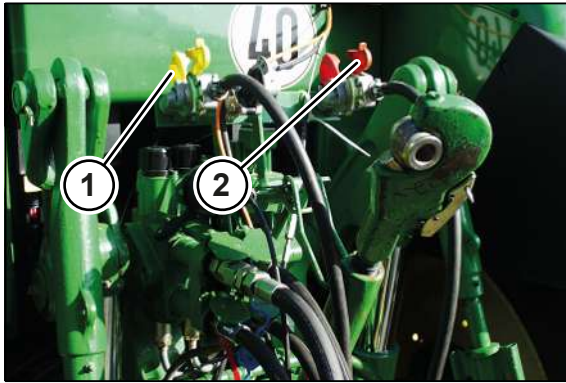

BP000-101

✓ The machine has been shut down and secured, [see Page 28](#).

Connecting

Observe the correct order when connecting the compressed air lines.

- ▶ Firstly, connect the brake line (1) (yellow coupling head).
- ▶ Then connect the supply line (2) (red coupling head).

Disconnecting

Observe the correct order when disconnecting the compressed air lines.

- ▶ Firstly, disconnect the supply line (2) (red coupling head).
- ▶ Then disconnect the brake line (1) (yellow coupling head).

7.6 Connecting the road lighting

NOTICE

Short circuit caused by impurities and moisture in the plug connection

The machine may be damaged by a short circuit.

- ▶ Make sure that the plugs and sockets are clean and dry.

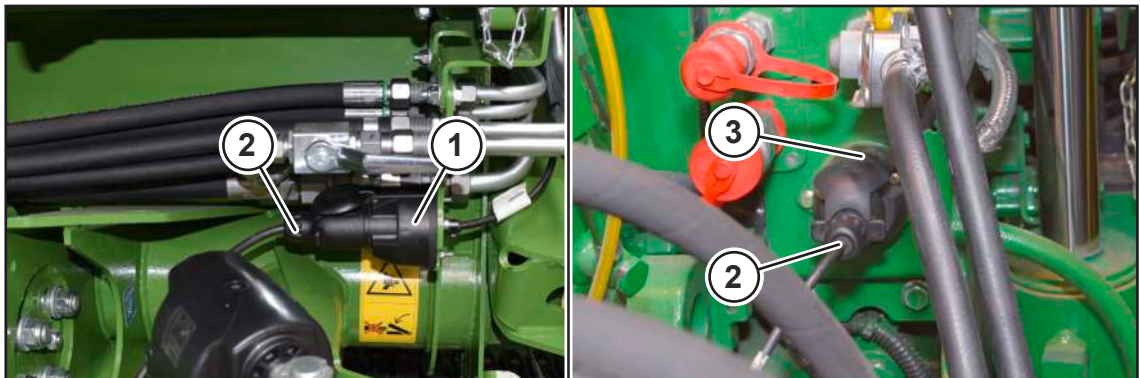

BPG000-067

The road travel lighting is connected by means of the enclosed 7-pin lighting cable (2).

- ✓ The machine has been shut down and secured, [see Page 28](#).
- ▶ Connect the 7-pin plug of the lighting cable (2) to the 7-pin socket (1) of the machine.
- ▶ Connect the 7-pin plug of the lighting cable (2) to the 7-pin socket (3) of the tractor.
- ▶ Route the lighting cable (2) so that it does not come into contact with the tractor wheels or other moving parts of the machine.

7.7 Mounting safety chain

 **WARNING**

Risk of accident due to a incorrectly dimensioned safety chain

When using an incorrectly dimensioned safety chain, the safety chain may tear if the machine loosens unintentionally. This may result in serious accidents.

- ▶ Always use a safety chain with a minimum tensile strength of 89 kN (20,000 lbf).

 **WARNING**

Risk of injury or damage to the machine due to incorrectly installed safety chain.

If the installed safety chain is too taut or too slack, the safety chain may tear. As a result, people may be seriously injured or the tractor and machine may be damaged.

- ▶ Install the safety chain in such a way that, when cornering, it is not tensioned and does not come into contact with the tractor wheels or other parts of the tractor or machine.

INFO

The country-specific regulations for using the safety chain during transportation of the machine must be observed.

This safety chain is on the net storage container on the left side of the machine.

The safety chain serves as an additional safety precaution for trailed devices in case these come loose from the hitch during transport. Attach the safety chain with the respective mounting parts to the hitching device holder of the tractor or to another specified coupling point. The safety chain should have enough play when driving around curves.

- ✓ The machine has been shut down and secured, [see Page 28](#).

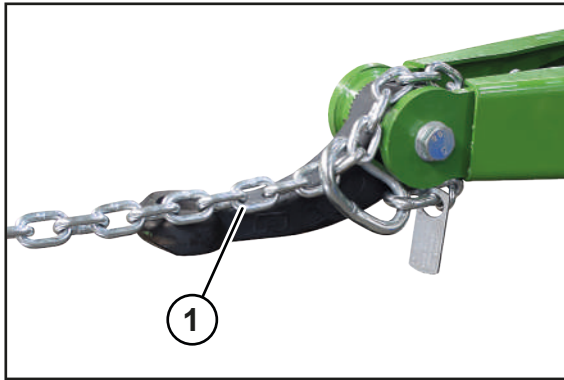

RP000-104

- ▶ Mount the safety chain (1) on the machine.

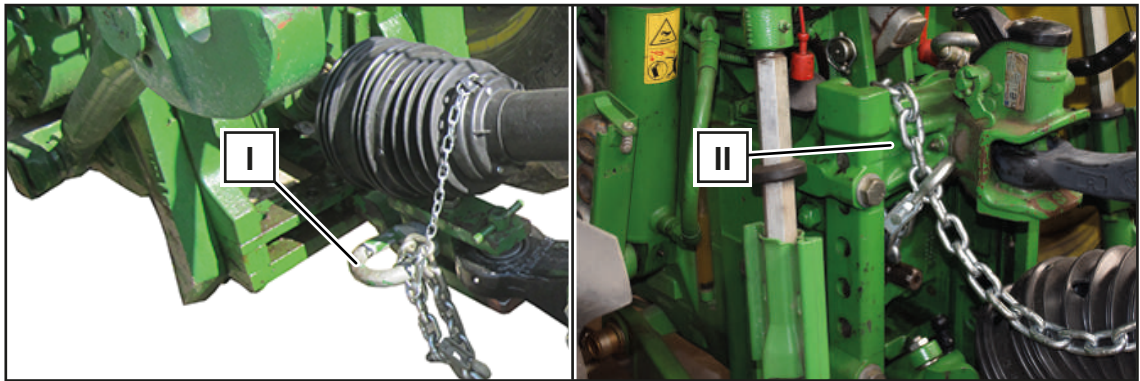

RP001-623

- ▶ Install the safety chain (1) at a suitable position (for example: [I] or [II]) on the tractor.

7.8 Mounting the catch loop

For "Catch loop" version

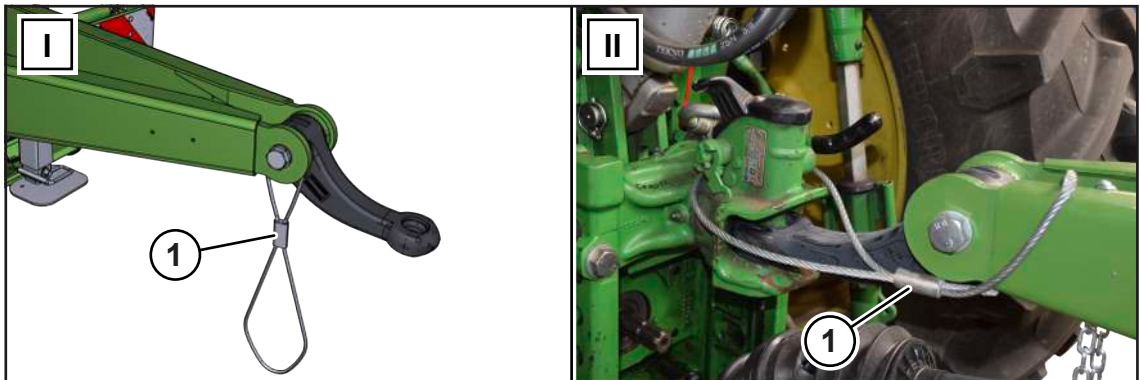

RP001-607

The catch loop (1) is used for the additional protection of hitched machines.

The catch loop (1) is pre-mounted at the drawbar in position (I).

- ✓ The machine has been shut down and secured, [see Page 28](#).
- ▶ Fasten the catch loop (1) at a suitable position at the rear of the tractor, e.g. position (II).

7.9 Connecting the KRONE DS 100 operation unit

NOTICE

Short circuit caused by impurities and moisture in the plug connection

The machine may be damaged by a short circuit.

- ▶ Make sure that the plugs and sockets are clean and dry.

Tractors with integrated ISOBUS system

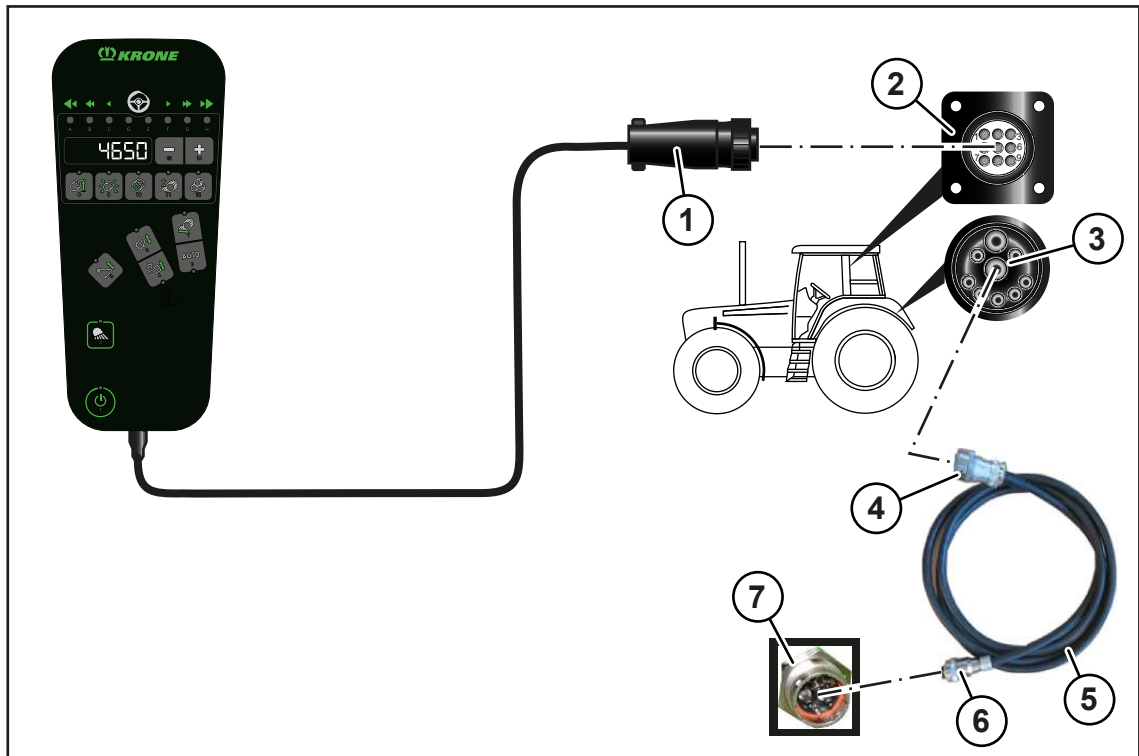

EQG003-125

- ✓ The machine has been shut down and secured, [see Page 28](#).

Connection terminal to tractor

- ▶ Connect the 9-pin plug (1) of the terminal to the 9-pin socket (2) (In-cab).

Connection tractor to machine

INFO

The cable (5) can be ordered by quoting the order number 20 086 886 *.

- ▶ Connect the 9-pin plug (4) of the cable (5) to the 9-pin ISOBUS socket (3) of the tractor.
- ▶ Connect the 11-pin plug (6) of the cable (5) to the 11-pin socket (7) of the machine.

Tractors without ISOBUS system

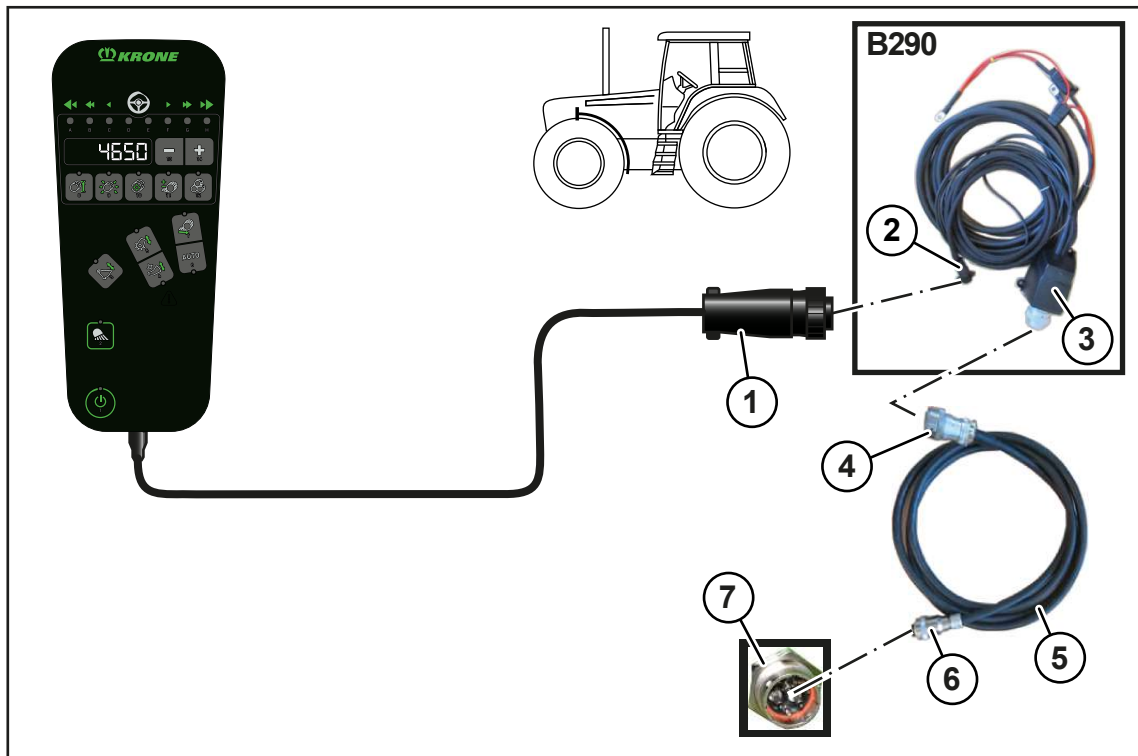

EQG003-124

- ✓ The machine has been shut down and secured, [see Page 28](#).
- ✓ The accessories kit B290 “KRONE tractor retrofitting” is mounted.

Connection terminal to tractor

- ▶ Connect the 9-pin plug (1) of the terminal to the 9-pin socket (2) (In-cab).

Connection tractor to machine

INFO

The cable (5) can be ordered by quoting the order number 20 086 886 *.

- ▶ Connect the 9-pin plug (4) of the cable (5) to the 9-pin ISOBUS socket (3) of the tractor.
- ▶ Connect the 11-pin plug (6) of the cable (5) to the 11-pin socket (7) of the machine.

7.10 Connecting KRONE terminal DS 500

NOTICE

Short circuit caused by impurities and moisture in the plug connection

The machine may be damaged by a short circuit.

- ▶ Make sure that the plugs and sockets are clean and dry.

Tractors with integrated ISOBUS system

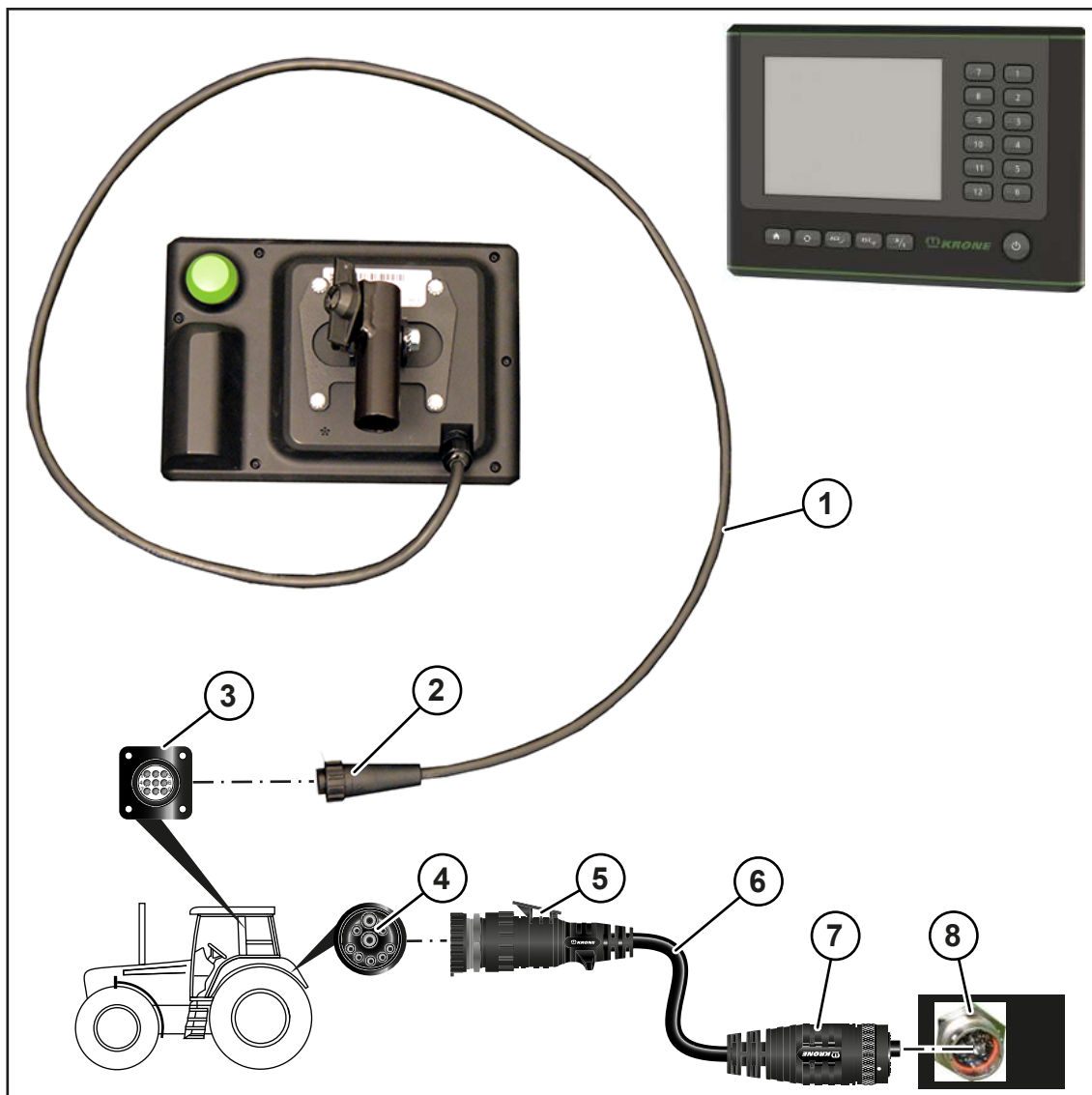

EQ003-251

- ✓ The machine has been shut down and secured, [see Page 28](#).

Connection terminal to tractor

- ▶ Connect the 9-pin plug (2) of the cable (1) to the 9-pin socket (3) (In-cab).

Connection tractor to machine

INFO

The cable (6) can be ordered by quoting the order number 20 086 886 *.

- ▶ Connect the 9-pin plug (5) of the cable (6) to the 9-pin ISOBUS socket (4) of the tractor.
- ▶ Connect the 11-pin plug (7) of the cable (6) to the 11-pin socket (8) of the machine.

Tractors without ISOBUS system

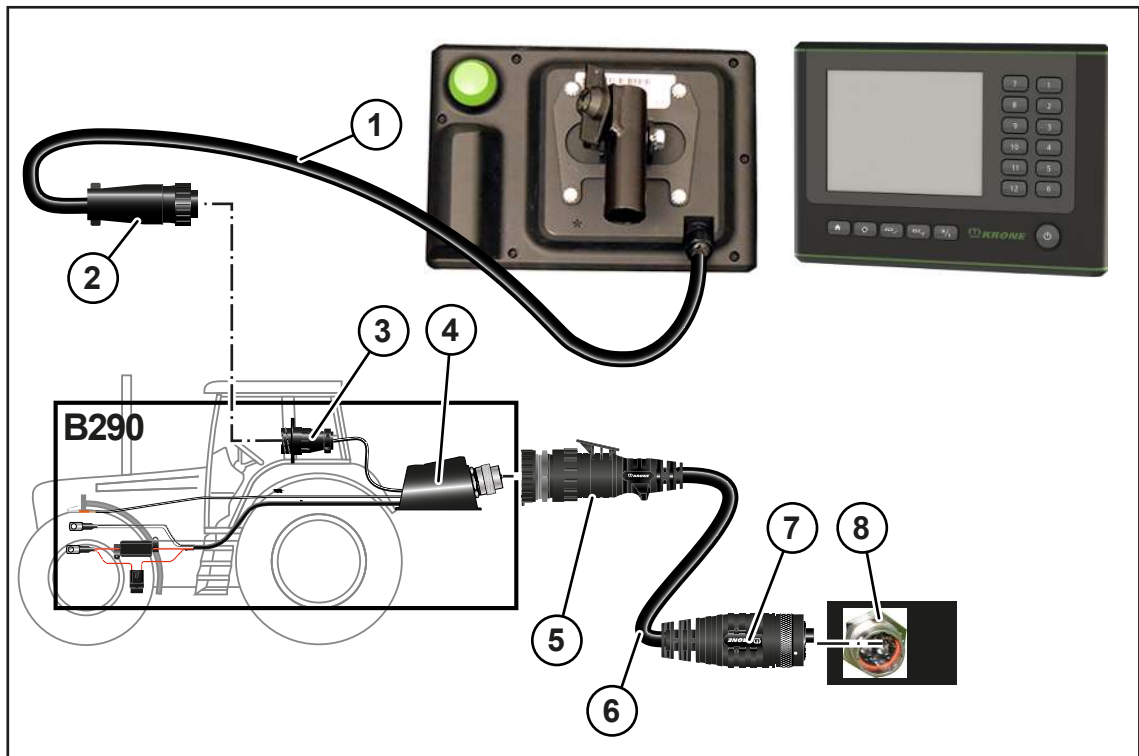

EQ003-252

- ✓ The machine has been shut down and secured, [see Page 28](#).
- ✓ The accessories kit B290 “KRONE tractor retrofitting” is mounted.

Connection terminal to tractor

- ▶ Connect the 9-pin plug (2) of the cable (1) to the 9-pin socket (3) (In-cab).

Connection tractor to machine

INFO

The cable (6) can be ordered by quoting the order number 20 086 886 *.

- ▶ Connect the 9-pin plug (5) of the cable (6) to the 9-pin ISOBUS socket (4) of the tractor.
- ▶ Connect the 11-pin plug (7) of the cable (6) to the 11-pin socket (8) of the machine.

7.11 Connecting the KRONE ISOBUS terminal (CCI 800, CCI 1200)

NOTICE

Short circuit caused by impurities and moisture in the plug connection

The machine may be damaged by a short circuit.

- ▶ Make sure that the plugs and sockets are clean and dry.

INFO

To mount the terminal in the tractor cabin, observe the provided operating instructions of terminal.

Tractors with integrated ISOBUS system

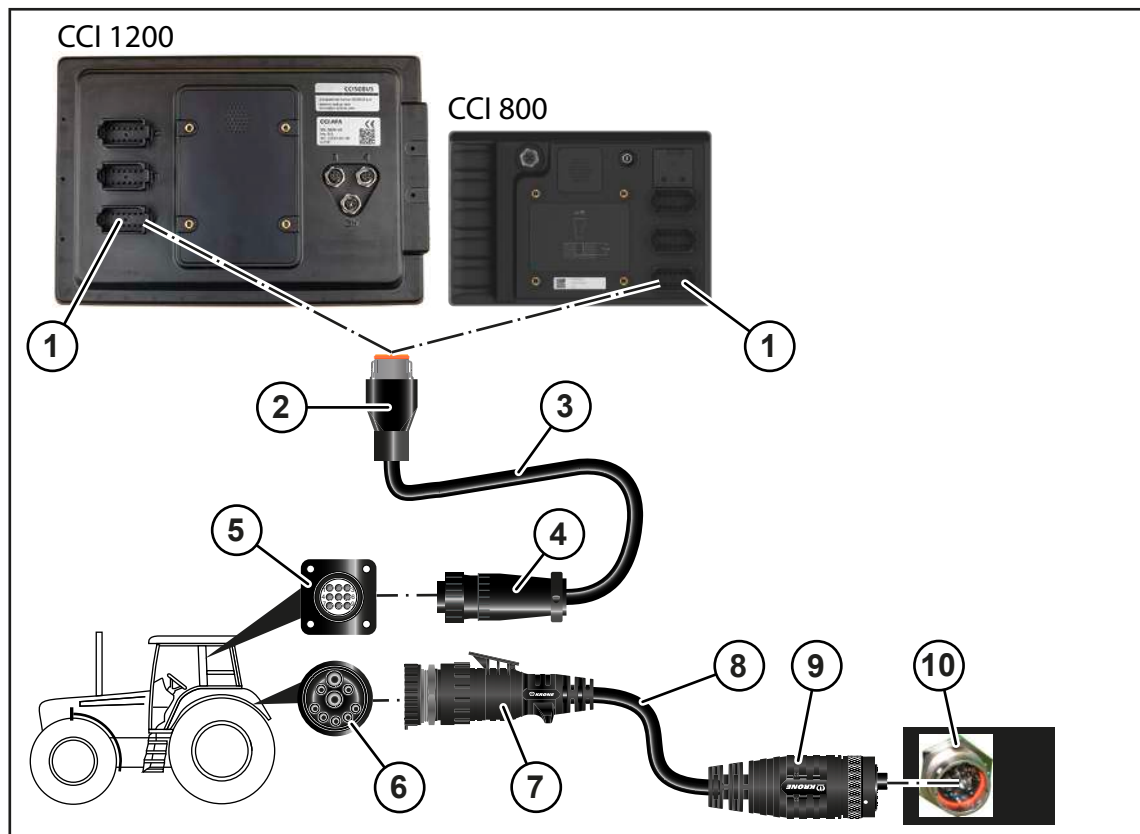

EQ001-173

✓ The machine has been shut down and secured, [see Page 28](#).

Connection terminal to tractor

- ▶ Connect the 12-pin plug (2) of the cable (3) to the 12-pin socket (1) of the terminal.
- ▶ Connect the 9-pin plug (4) of the cable (3) to the 9-pin socket (5) (In-cab).

Connection tractor to machine

INFO

The cable (8) can be ordered by quoting the order number 20 086 886 *.

- ▶ Connect the 9-pin plug (7) of the cable (8) to the 9-pin ISOBUS socket (6) of the tractor.
- ▶ Connect the 11-pin plug (9) of the cable (8) to the 11-pin socket (10) of the machine.

Tractors without ISOBUS system

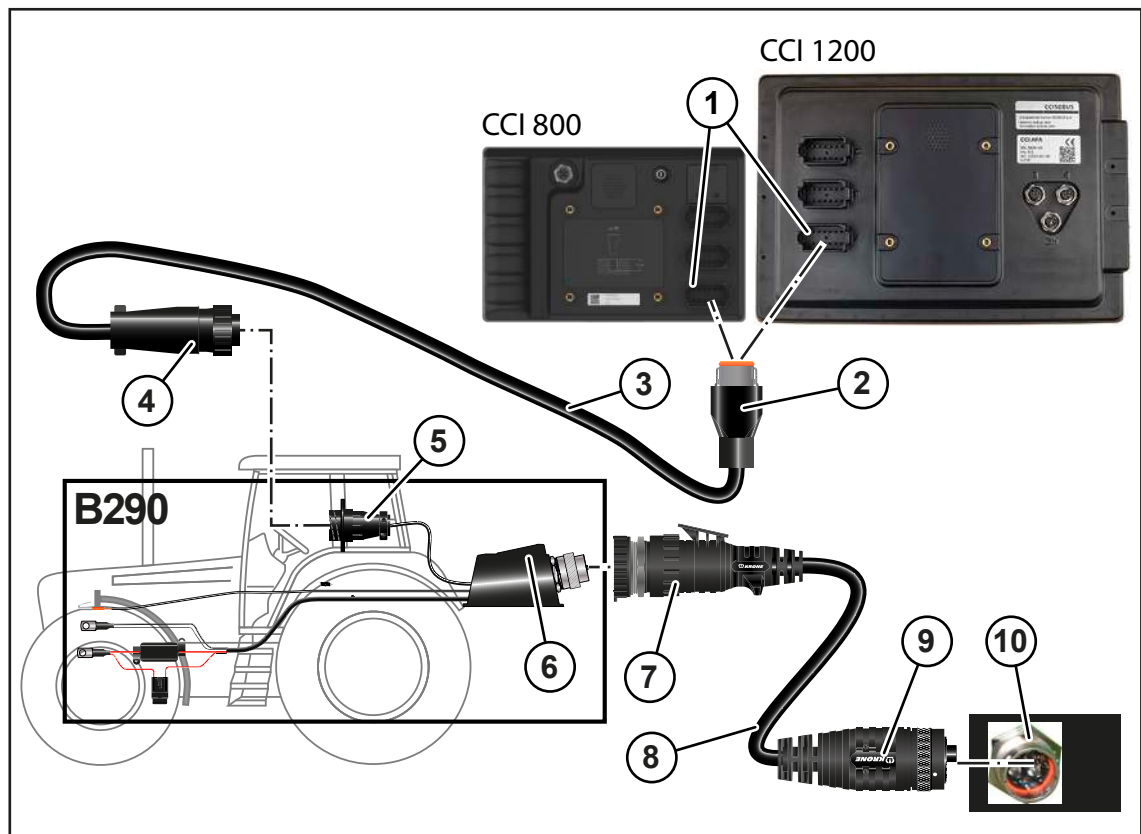

EQ001-181

- ✓ The machine has been shut down and secured, [see Page 28](#).
- ✓ The accessories kit B290 “KRONE tractor retrofitting” is mounted.

Connection terminal to tractor

- ▶ Connect the 12-pin plug (2) of the cable (3) to the 12-pin socket (1) of the terminal.
- ▶ Connect the 9-pin plug (4) of the cable (3) to the 9-pin socket (5) (In-cab).

Connection tractor to machine

INFO

The cable (8) can be ordered by quoting the order number 20 086 886 *.

- ▶ Connect the 9-pole plug (7) of the cable (8) to the 9-pole ISOBUS socket (6) of the tractor.
- ▶ Connect the 11-pole plug (9) of the cable (8) to the 11-pole socket (10) of the machine.

7.12 Connecting foreign ISOBUS terminal

NOTICE

Short circuit caused by impurities and moisture in the plug connection

The machine may be damaged by a short circuit.

- ▶ Make sure that the plugs and sockets are clean and dry.

INFO

To mount the terminal in the tractor cabin, observe the provided operating instructions of terminal.

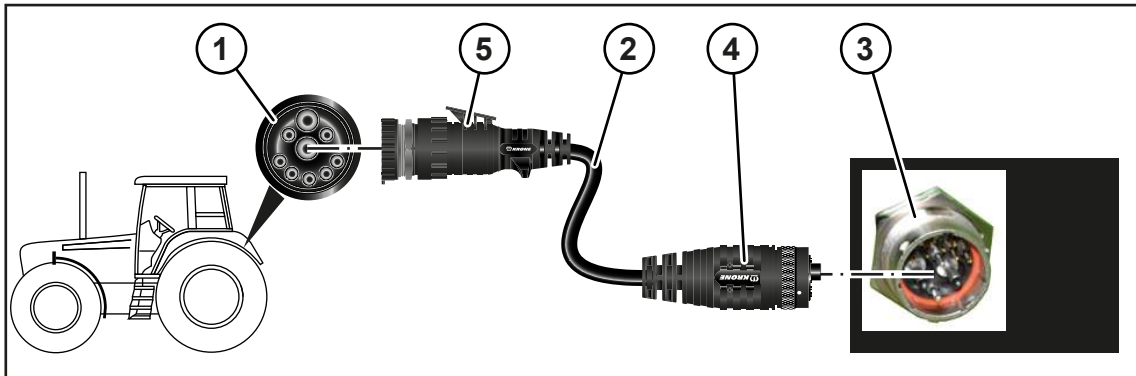

EQ001-146

- ✓ The machine has been shut down and secured, [see Page 28](#).

Connection tractor to machine

- ▶ Connect the 9-pole plug (5) of the cable (2) to the 9-pole ISOBUS socket (1) of the tractor.
- ▶ Connect the 11-pole socket (4) of the cable (2) to the 11-pole socket (3) of the machine.

7.13 Connecting joystick

INFO

Follow the supplied joystick operating instructions for attachment of the joystick in the tractor cabin.

KRONE ISOBUS terminal on tractors with integrated ISOBUS system

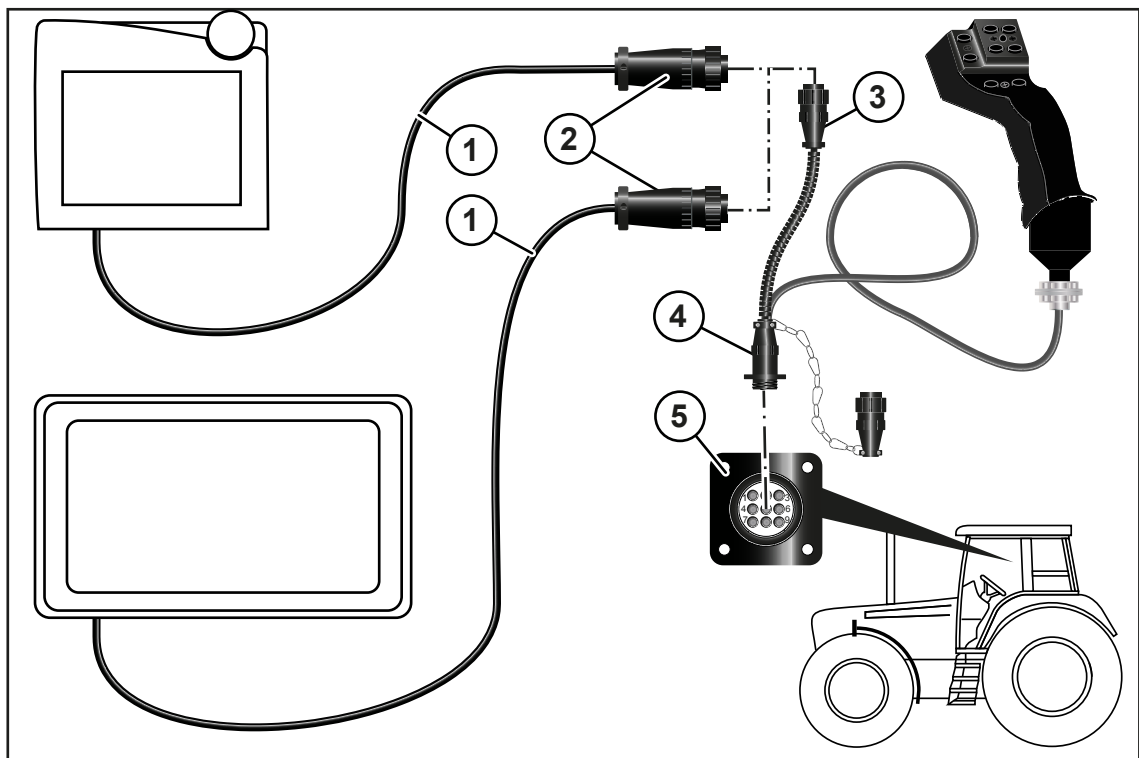

EQ001-150

- ✓ The machine has been shut down and secured, [see Page 28](#).
- ▶ Connect the 9-pin plug (2) of the cable (1) to the 9-pin socket (3) of the joystick.
- ▶ Connect the 9-pin plug (4) of the joystick to the 9-pin socket (5) (In-cab).

KRONE ISOBUS terminal on tractors without integrated ISOBUS system

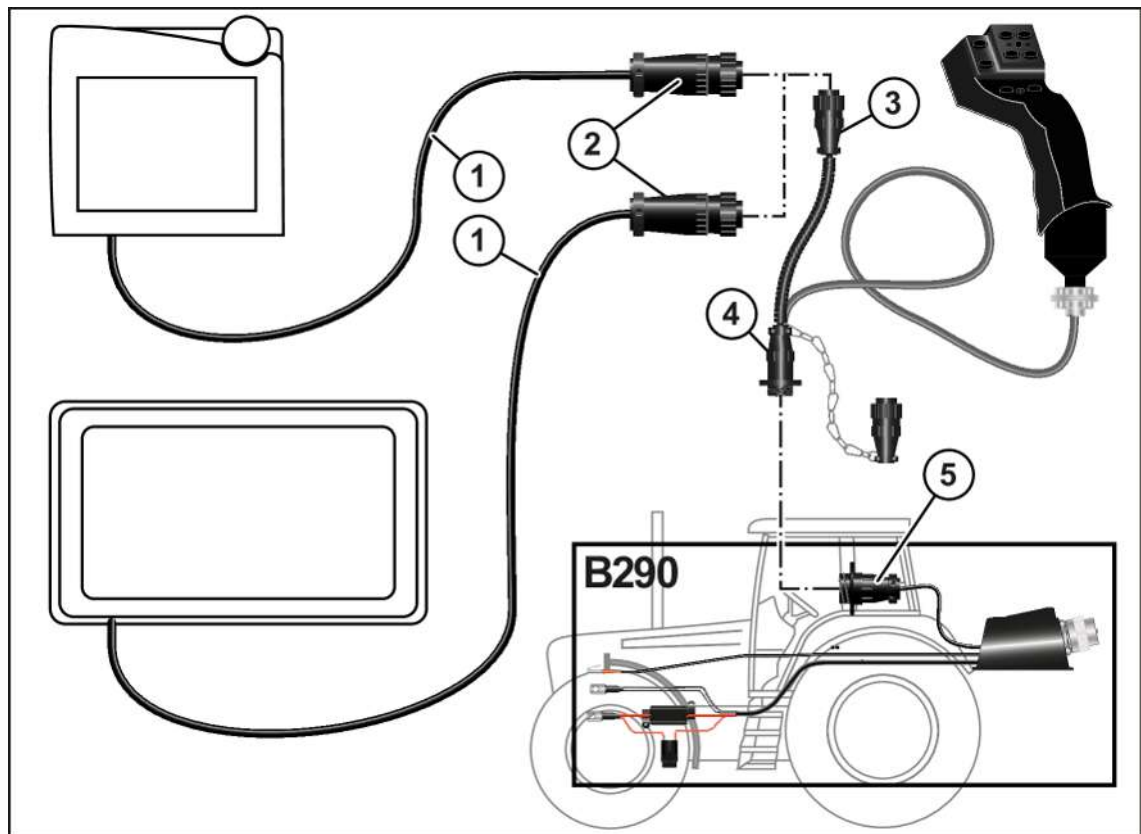

EQ001-151

- ✓ The machine has been shut down and secured, [see Page 28](#).
- ✓ The accessories kit B290 “KRONE tractor retrofitting” is mounted.
- ▶ Connect the 9-pin plug (2) of the cable (1) to the 9-pin socket (3) of the joystick.
- ▶ Connect the 9-pin plug (4) of the joystick to the 9-pin socket (5) (In-cab).

7.14 Connecting the camera to the KRONE ISOBUS terminal CCI 800 or CCI 1200

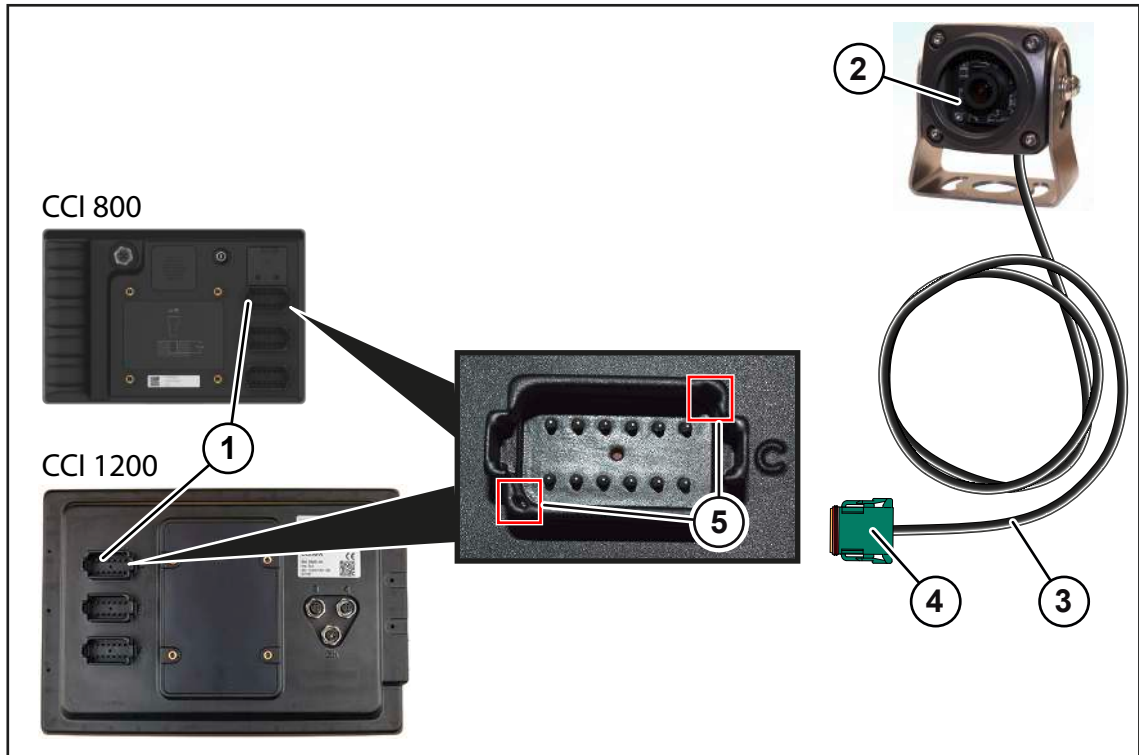

EQ000-212

- ▶ Insert the plug (4) on the camera (2) cable (3) into the connection C (1) of the KRONE ISOBUS terminal CCI 800 or CCI 1200 .
- ▶ To connect the plug (4) correctly, ensure that it is aligned with the marked points (5).

8 Operation

WARNING

Risk of injury due to non-observance of relevant safety notices

If the relevant safety notices are not observed, persons may get seriously injured or killed.

- ▶ To avoid accidents, the basic safety instructions must be read and observed, [see Page 16](#).

WARNING

Risk of injury due to non-observance of safety instructions

If the relevant safety routines are not observed, persons may be seriously injured or killed.

- ▶ The safety routines must be read and observed to avoid accidents, [see Page 28](#).

WARNING

Risk of injury due to unpredictable movement of the round bales when the machine is operating on a slope

If round bales are deposited on a slope, they may start moving on their own. Once round bales have started moving, their weight and cylindrical shape may cause serious accidents and injure people.

- ▶ On slopes, deposit round bales in manual mode only.
- ▶ On slopes, always deposit round bales in such a way that they cannot start moving on their own.

8.1 Preparation before baling

- ✓ The pick-up is in working position, [see Page 84](#).
- ✓ The crop press roller unit has been correctly set according to the amount of crops, [see Page 87](#).
- ✓ The wrapping material has been correctly inserted.
Twine tying: [see Page 101](#)
Net wrapping: [see Page 94](#)
- ✓ The baling pressure has been set.
For version with "operation unit DS 100": [see Page 115](#)
For the remaining terminals: [see Page 163](#)
- ✓ The bale diameter has been set.
For version with "operation unit DS 100": [see Page 113](#)
For the remaining terminals: [see Page 147](#)
- ✓ The required cutting length has been set, [see Page 205](#).
- ✓ The customer counter has been set to 0, [see Page 175](#).
- ✓ The tailgate is closed.
- ✓ The working screen has been selected, [see Page 146](#).

8.2 Filling the bale chamber

NOTICE

Machine damage due to machine overload

Too firm or too large round bales can damage the machine and reduce the service life considerably. In the event of an overload, forced tying is automatically actuated which is saved on the terminal.

- ▶ Press only round bales which do not exceed the maximum set bale diameter.
- ▶ Observe the following information on the even filling of the bale chamber.

NOTICE

Baling belts damaged by barrel-shaped round bales

Unevenly shaped and compressed round bales may damage the baling belts.

- ▶ Bale only evenly shaped and compressed round bales.
- ▶ Observe the following information on the even filling of the bale chamber.

To attain a consistent bale density inside the round bale, the bale chamber must be filled evenly. The appropriate swath width is important for this. The swath width is optimal when the swath has exactly the same width as the bale chamber.

Procedure

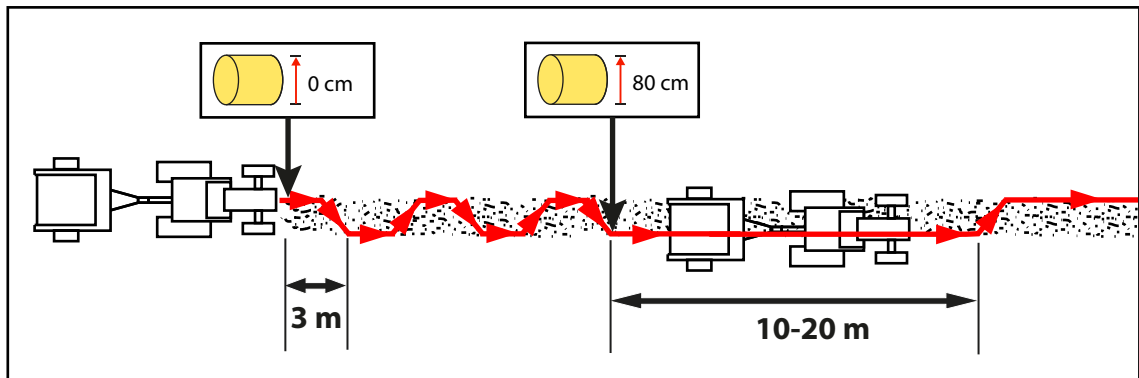

RP000-736

To obtain an evenly shaped round bale, the right and left sides of the swath must be changed quickly while crops are being picked up.

At the beginning, change the side every **3 m** until the bale diameter is approx. 80 cm.

Next, crops must be picked up on each side approx. every **10 ... 20 m**. The crops will then be distributed evenly on the right and left sides of the bale chamber.

While crops are being picked up, it is advisable to monitor the baling belts in the machine:

- If the baling belts move to the left, steer the tractor to the right to pick up the crops on the left side of the bale chamber.
- If the baling belts move to the right, steer the tractor to the left to pick up the crops on the right side of the bale chamber.
- ▶ At the start of the baling process change quickly from the left to the right side of the swath so that crops can be fed alternately on the left and right sides of the bale chamber. On each side pick up crops approx. **3 m** long (Section (X)). Perform this quick change until a bale diameter of approx. **80 cm** has been reached.
- ▶ Drive approx. **10–20 m** and pick up crops on one side of the swath.
- ▶ Quickly change the side, drive on the other side approx. **10–20 m** and pick up crops.
- ▶ Repeat the procedure until the required bale diameter has been reached and a tying cycle can be actuated.

If swaths are too wide

The pressed round bales do not have an exact shape. Also the round bale is frayed on the sides and difficult to eject from the bale chamber.

- ▶ Make the swaths narrower on the field.
- ▶ Reduce the baling pressure, [see Page 200](#).

If swaths are too narrow

- ▶ Also retain the procedure for driving on alternate sides.
- ▶ Drive quickly over the swath.
- ▶ Do not drive in wavy lines.
- ▶ If the baling belts do not run smoothly, reduce the PTO speed.

If the swath is small and flat

- ▶ Reduce the PTO speed.
- ▶ Increase the driving speed.

For short and brittle straw

- ▶ Reduce the baling pressure.
For version with "operation unit DS 100": [see Page 115](#).
For the remaining terminals: [see Page 163](#).
- ▶ Reduce the number of blades in the cutting unit or completely swivel out the blades, [see Page 88](#).
- ▶ Start the tying cycle earlier than indicated.
- ▶ To largely prevent short, brittle straw from falling out of the bale chamber when driving from one swath to the next swath, switch off the PTO shaft in the meantime.

Driving speed

KRONE recommends a driving speed of 5 ... 12 km/h.

The driving speed while working must be adapted to the following circumstances:

- Type of crop
- Moisture content of crops
- Swath height
- Selected cutting length
- Ground conditions

Additional tips for filling the bale chamber

- Reduce the driving speed at the end of the filling process to obtain consistent bale sizes.
- Start the tying cycle at the end of the filling process. This will prevent crops from getting between the net layers.
- The shorter the crops in the bale chamber, the greater the friction on the side walls. As such, the overload clutch can engage more frequently. Moreover, short crops can be compressed more easily. That's why the baling pressure can be lowered with the blades swivelled in without the bale density being reduced, [see Page 200](#). The response of the overload clutch can be reduced in this way.
- Do not operate the machine for too long a time with empty bale chamber.
- After the tying mechanism has been actuated 3 times, the accumulator of the machine is empty and must be filled again, [see Page 255](#).

8.3 Completing the baling process, starting tying cycle and ejecting round bales

- ▶ **For version with "Operation unit DS 100":** Read off the status of the bale chamber filling on the warning lights of the DS 100, [see Page 108](#).
- ▶ **For the remaining terminals:** Read off the status of the bale chamber filling on the terminal, [see Page 140](#).
- ▶ Stop the tractor.
- ▶ Start the tying process in automatic mode or start it in manual mode.
- ▶ Wait until the tying process is complete.
- ▶ Open the tailgate and eject the round bale.
- ▶ Close the tailgate.
- ▶ Start the next baling process.

8.4 Reducing the pressure on the side walls of the bale chamber

If very heavy crops without structure are picked up, the round bales may become very hard and press on the side walls of the machine. Then reliable rotation of the round bale can be increased in the bale chamber by taking the following measures:

- ▶ To reduce the pressure on the side walls, do not drive too far to the right or left.
- ▶ Take the outer blades out of the cutting unit or completely switch off the cutting unit.
- ▶ Reduce the baling pressure, [see Page 200](#).

8.5 Operating the support jack

INFO

In order to increase the base of the support jack when the ground is soft, use a suitable support.

The support jack is used to keep the machine stable when it is not connected to the tractor. The support jack must be used whenever the machine is parked.

- ✓ The machine is connected to the tractor, [see Page 59](#).
- ✓ The machine has been shut down and secured, [see Page 28](#).

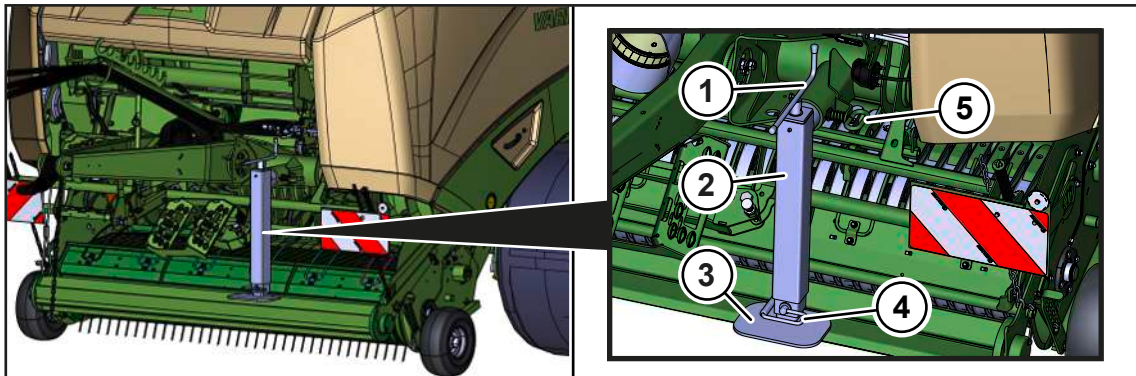

RPG000-063

Moving the support jack into support position

- ▶ Pull the handle (5) and fold the support jack (2) downwards.
- ▶ Turn the crank handle (1) several revolutions anti-clockwise.

WARNING! Crush hazard due to the support jack! Keep hands and feet out of the danger zone of the support jack.

- ▶ Pull out the securing pin (4), extend the parking support (2) and secure the position using the securing pin (4).
- ▶ Turn the support jack (2) anti-clockwise firmly down onto the ground using the crank handle (1) until the drawbar is relieved.

Moving the support jack into transport position

- ▶ Turn the crank handle (1) several revolutions clockwise until the support plate (3) is relieved.

WARNING! Crush hazard due to the support jack! Keep hands and feet out of the danger zone of the support jack.

- ▶ Pull out the securing pin (4), push in the support jack (2) and secure the position with the securing pin (4).
- ▶ Turn the support jack (2) clockwise all the way up using the crank handle (1).
- ▶ Fold the side support jack (2) upwards and engage it.
- ▶ Turn the crank handle (1) towards the machine so that it cannot touch the tractor wheel.

8.6 Releasing/applying the parking brake

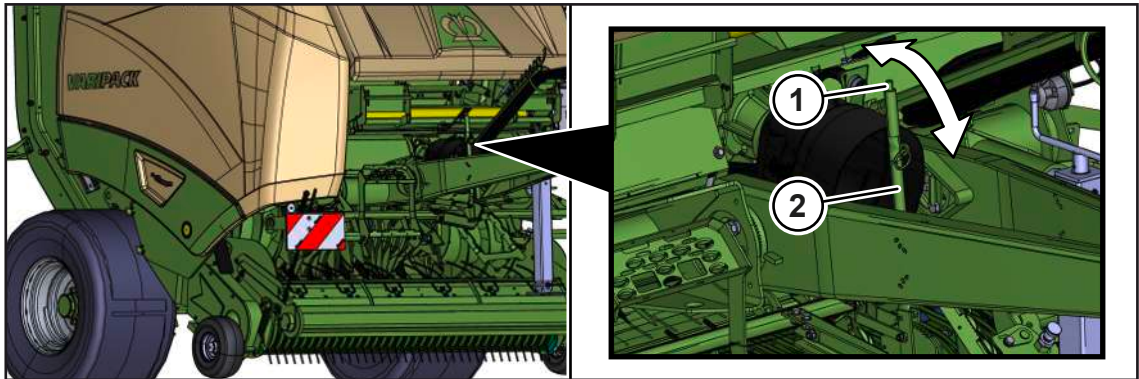

RPG000-131

The parking brake (2) is located on the front side of the machine on the drawbar. The parking brake (2) is used to secure the machine from unintentionally rolling away, .

In order to prevent the machine from rolling away, also use the wheel chocks, [see Page 82](#).

✓ The tractor engine is switched off, the ignition key is removed and taken with you.

Applying the parking brake (2)

- ▶ Apply the parking brake (2) until the resistance has increased noticeably.

Releasing the parking brake (2)

- ▶ Push in the key (1) and press parking brake (2) all the way down.

Attaching safety cable of the parking brake (for "Hydraulic brake export" version)

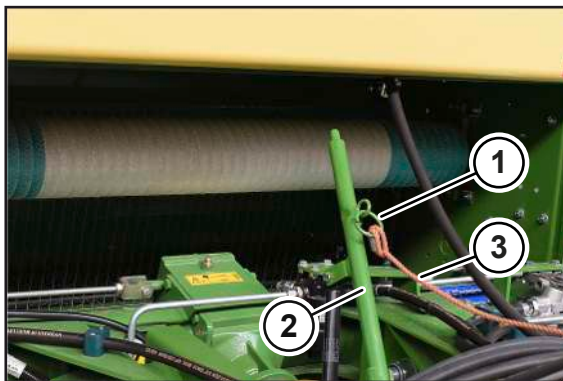

RP000-399

The safety cable (3) applies the parking brake (2) if the machine breaks away from the tractor while it is driving.

- ▶ Fasten the safety cable (3) to the machine using the smaller loop at the ring (1) of the parking brake (2).
- ▶ Attach the other end of the safety cable (3) to a suitable point at the rear of the tractor.
- ▶ Ensure that the safety cable (3) cannot come loose and does not come into contact with moving parts, for example the tractor tyres.

8.7 Using ladders for the tying system

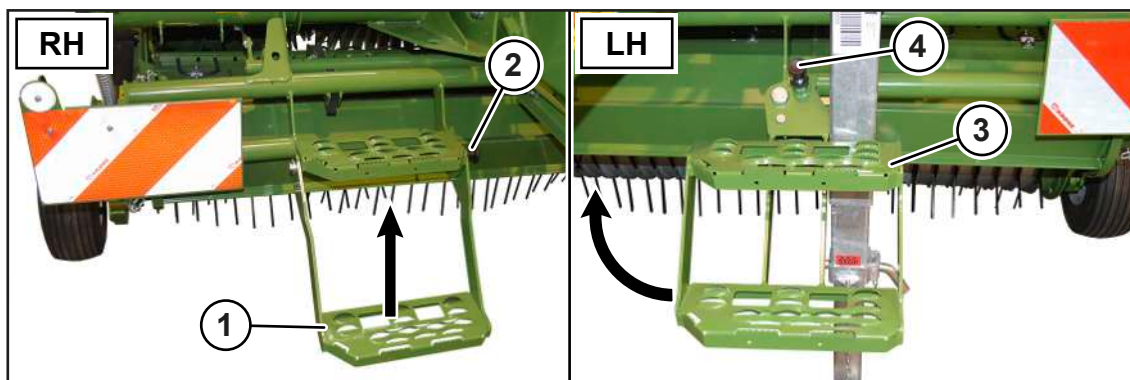

RP000-812

The ladders (1) and (3) are located at the front of the machine to facilitate tying and to insert the net more easily.

When driving on roads and working in fields, the ladders (1) and (3) must be folded up to prevent damage to the tractor tyres and to the ladders themselves.

- ✓ The machine has been shut down and secured, [see Page 28](#).

Folding the ladder (1) up and down (RH)

- ▶ **Folding up:** Fold the lowest step of the ladder (1) upwards in the direction of the arrow until it engages.
- ▶ **Folding down:** Pull the knob (2) and fold the ladder downwards against the direction of the arrow.

Folding the ladder (3) up and down (LH)

- ▶ **Folding up:** Pull the knob (4) and fold the side ladder (3) upwards to the left in the direction of the arrow until it engages.
- ▶ **Folding down:** Pull the knob (4) and fold the side ladder (3) downwards against the direction of the arrow until it engages.

8.8 Fitting wheel chocks

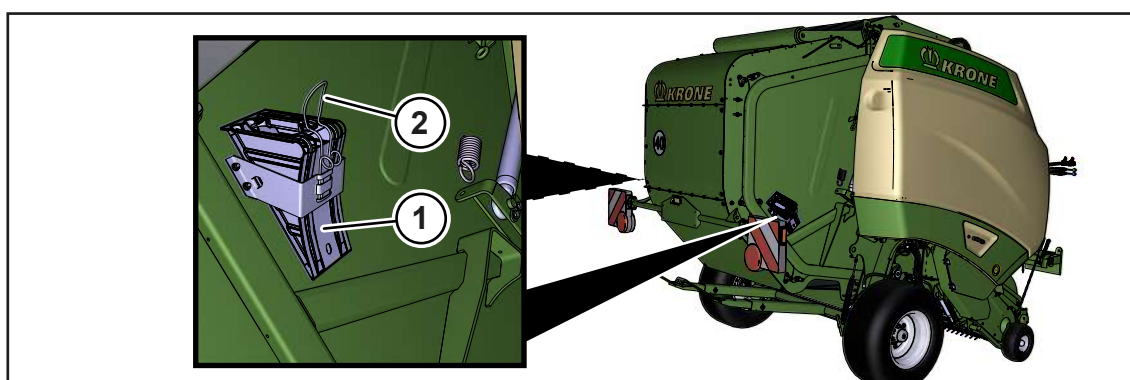

RPG000-012

The wheel chocks (1) secure the machine against rolling away. 2 wheel chocks are affixed to the machine.

For "Parking brake" version: In order to prevent the machine from rolling away, use the parking brake in addition to the wheel chocks (1), [see Page 81](#).

- ✓ The machine is parked on a stable, horizontal and even surface.
- ✓ The machine has been shut down and secured, [see Page 28](#).
- ▶ To dismount the wheel chocks (1) from the machine, press the supports (2) down, pull the wheel chocks (1) upwards, and remove them.

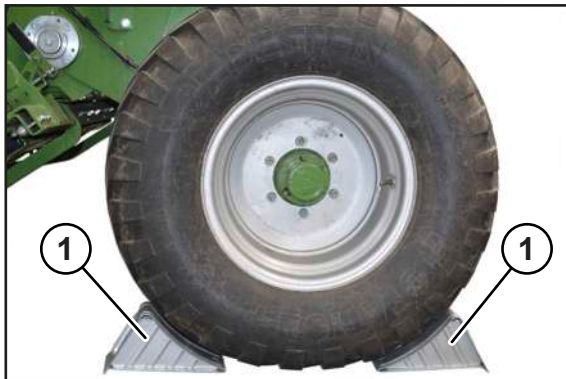

RPG000-180

- ▶ Place the wheel chocks (1) so tightly in front of and behind the same wheel that the machine is prevented from rolling away.

8.9 Removing/mounting the safety device which prevents unauthorised use

The safety device is used to prevent unauthorised use when the machine has been switched off.

- ✓ The machine has been parked, [see Page 193](#).

For version with "ball-head attachment" or "drawbar eye attachment"

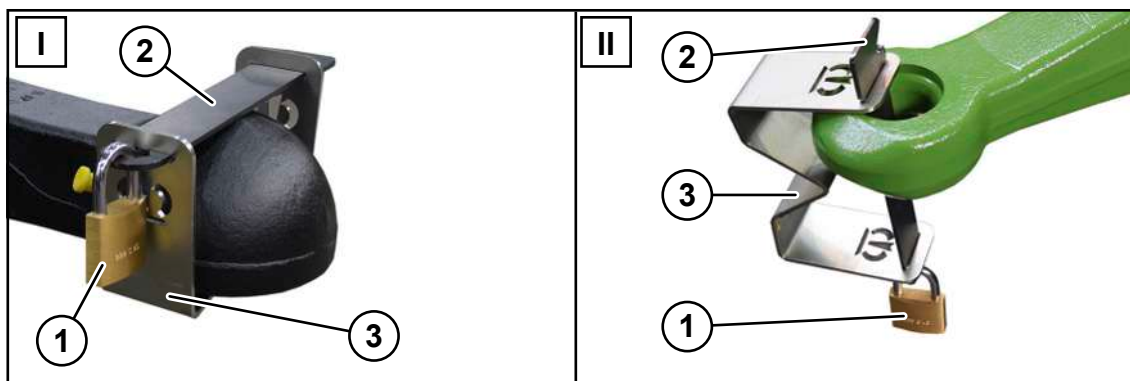

KS000-414

I Version with ball-head attachment

II Version with drawbar eye attachment

Removing

- ▶ Remove the padlock (1), the latch (2) and the bracket (3) and take them with you.

Mounting

- ▶ Mount the bracket (3) with the latch (2) and secure with the padlock (1) and keep the key in a safe place.

8.10 Pick-up

8.10.1 Bringing the pick-up to transport/working position

Working position

WARNING! Risk of injury due to falling pick-up! While the pick-up is being lowered, remove people from the movement range of the pick-up.

- ▶ For "Operation unit DS 100" version: To preselect the pick-up, press the  key, [see Page 108](#).

⇒ The indicator lamp above the key lights up.

- ▶ For the other terminals: To preselect the pick-up, press the  key on the terminal, [see Page 138](#).

⇒ The key switches to .

- ▶ To lower the pick-up into the working position, actuate the control unit on the tractor (yellow, 3+).

Transport position

WARNING! Risk of injury due to rising pick-up! While the pick-up is being raised, tell people to leave the movement range of the pick-up.

- ▶ For "Operation unit DS 100" version: To preselect the pick-up, press the  key, [see Page 108](#).

⇒ The indicator lamp above the key lights up.

- ▶ For the other terminals: To preselect the pick-up, press the  key on the terminal, [see Page 138](#).

⇒ The key switches to .

- ▶ To lift the pick-up into the transport position, actuate the control unit on the tractor (yellow, 3+).

8.10.2 Setting the pick-up working height

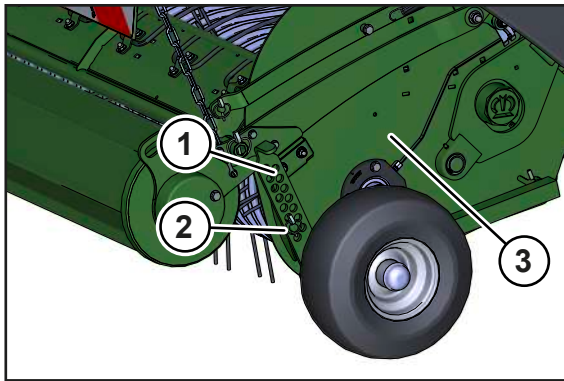

RPG000-151

The working height of the pick-up (3) must be set so that the distance between the tines and the ground is approx. **20-30 mm**. Also the working height of the pick-up (3) must be adjusted to the ground conditions.

✓ The drawbar height has been set correctly, [see Page 55](#).

Make the following setting on the right and left sides of the pick-up in the same way:

- ▶ Lift the pick-up (3) hydraulically, [see Page 84](#).
- ▶ Shut down and safeguard the machine, [see Page 28](#).
- ▶ Remove the linch pin (2).
- ▶ Push the perforated bar (1) to the required position and secure it with the linch pin (2).
- ▶ Lower the pick-up (3) hydraulically, [see Page 84](#).
- ▶ Shut down and safeguard the machine, [see Page 28](#).
- ▶ Check whether the distance between the tines and the ground is approx. **20-30 mm**.
- ▶ If required, re-adjust the perforated bar (1).

8.10.3 Activating/deactivating the bearing pressure relief for the pick-up

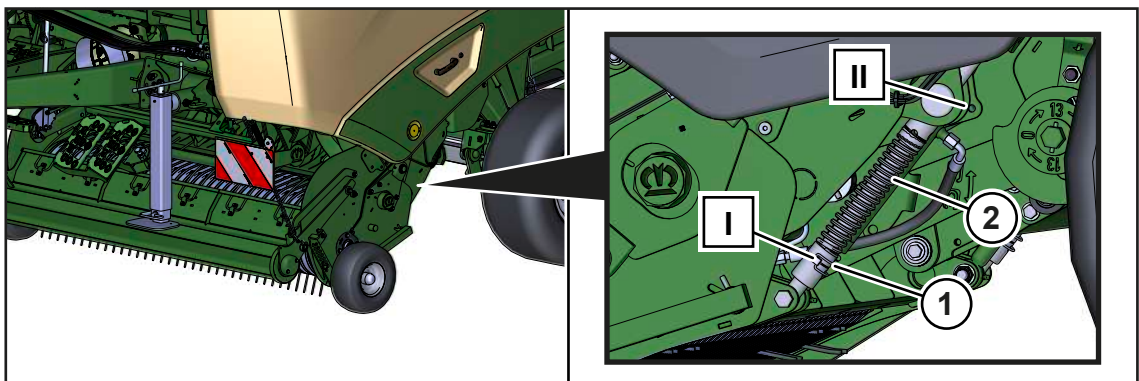

RPG000-153

To be able to negotiate uneven ground better, the pick-up is relieved on the right and left sides of the machine with the aid of the spring (2). This bearing pressure relief function can be activated or deactivated.

KRONE recommends activating the bearing pressure relief for the pick-up to protect the sward and to protect the machine from damage.

Position	Explanation
I	Bearing pressure relief for the pick-up activated
II	Bearing pressure relief for the pick-up deactivated, the linch pin (1) is located in the loss protection borehole.

Deactivating the bearing pressure relief

- ▶ Move the pick-up into the transport position, [see Page 84](#).
- ▶ Switch off the tractor, remove the ignition key and take it with you.

Make the following setting on the right and left sides of the machine in the same way:

- ▶ Dismount the linch pin (1) from position (I) and mount in position (II).
- ➔ The spring (2) has been relieved and therefore the bearing pressure relief for the pick-up has been deactivated. The spring (2) and the bushings can move freely on the shaft.

If the bearing pressure relief has been deactivated, the height of the pick-up can also be set, [see Page 86](#).

Activating the bearing pressure relief

- ▶ Move the pick-up into the transport position, [see Page 84](#).
- ▶ Switch off the tractor, remove the ignition key and take it with you.

Make the following setting on the right and left sides of the machine in the same way:

- ▶ Dismount the linch pin (1) from position (II) and mount in position (I).
- ➔ The spring (2) has been tensioned and therefore the bearing pressure relief for the pick-up has been activated.

2 positions can be selected in position (I):

- Borehole with notch: bearing pressure relief lower
- Borehole without notch: bearing pressure relief higher

Crop collection without using guide wheels

If the bearing pressure relief for the pick-up has been deactivated, the working height of the pick-up can be set independently of the guide wheels.

This is suitable for uneven ground and light crops.

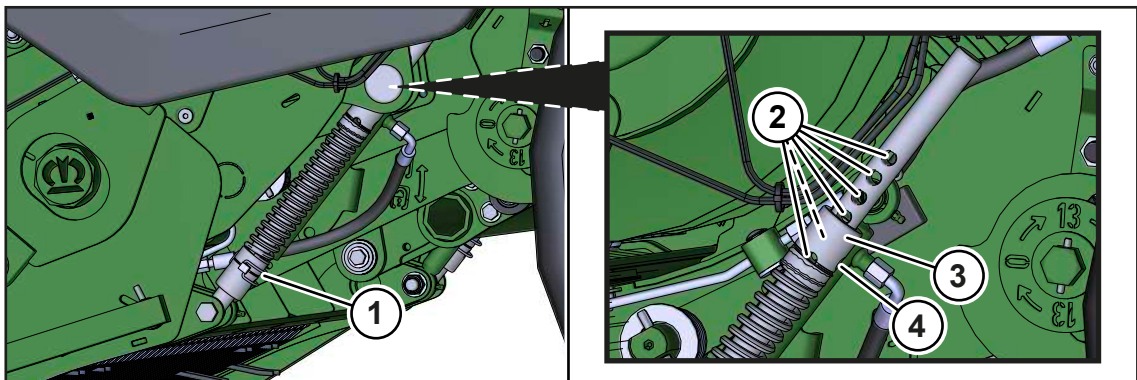

RP000-801

Make the following setting on the right and left sides of the machine in the same way:

- ▶ Move the pick-up into the transport position, [see Page 84](#).
- ▶ Switch off the tractor, remove the ignition key and take it with you.
- ▶ Push up the bushing (3) and insert the linch pin (1) into one of the boreholes (2) and secure.

If the gaps between the boreholes (2) are too great and therefore the working height cannot be set exactly enough:

- ▶ Use the borehole (4) without machined groove in the bushing (3).

The higher the borehole, the higher the pick-up has been set.

8.11 Crop press roller unit

 **WARNING**

Risk of injury if the machine is used without a crop press roller unit

The crop press roller unit is used for accident protection! If the machine is operated without a roller crop guide, people can be seriously injured or killed.

- ▶ Never operate the machine without a crop press roller unit.

8.11.1 Setting the crop press roller unit



RPG000-110

The crop press roller unit (3) guides the crops at the intake via the pick-up.

The height of the crop press roller unit (3) must be set so that the operating crop press roller (2) continuously touches the swath.

Adjusting the height of the crop press roller unit

Make the following setting on the right and left side of the pick-up in the same way:

- ✓ The machine has been shut down and secured, [see Page 28](#).
- ▶ Remove the linch pin (5).
- ▶ Hook in the chain (1) higher or lower according to the swath: In doing so, first thread the load-bearing chain link, then thread the chain overhang up to 2 more times.
- ▶ Mount the linch pin (5).

If the linch pin (5) is not required, the linch pin (5) can be inserted into the borehole (4).

8.11.2 Removing/mounting the baffle sheet on the crop press roller unit

In operation the baffle sheet must have been mounted on the crop press roller unit. The baffle sheet on the crop press roller unit can be briefly removed in the event of crop blockages.

Removing crop blockages: [see Page 105](#)

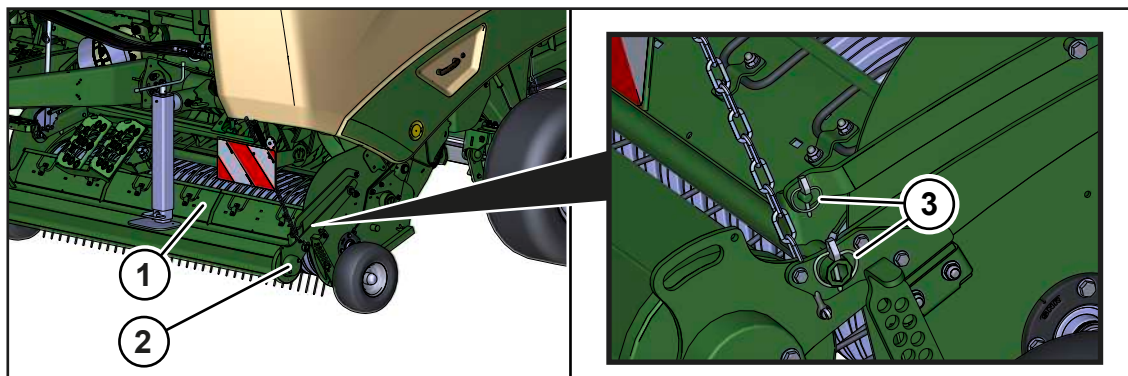

RPG000-152

✓ The machine has been shut down and secured, [see Page 28](#).

Dismounting

- ▶ Remove the lynch pins (3) from the right and left sides of the pick-up.
- ▶ Push the baffle sheet (1) to one side and remove.

Mounting

- ▶ Place the baffle sheet (1) on the crop press roller (2) and secure with the lynch pins (3) on the right and left sides of the pick-up.

8.12 Cutting unit

8.12.1 Lifting/lowering blade cassette

WARNING







Crush hazard due to lowering or lifting of the blade cassette

Lifting and lowering the blade cassette may crush body parts.

- ▶ Before lifting or lowering the blade cassette, ensure that there is nobody inside the danger zone of the blade cassette.
- ▶ Before doing any work on the blade cassette, shut down and safeguard the machine, [see Page 28](#).

Lowering the blade cassette



When the blade cassette is lowered, the blade cassette is moved into maintenance position. In a closed sequence, first the blade cassette is lowered and then the blades swivel out (deactivated). This maintenance position is used, for example, to change the blades or to remove crop blockages.

- ▶ **For "Operation unit DS 100" version:** To preselect the blade cassette, press the  key, *see Page 108*.
 - ⇒ The indicator lamp below the key lights up.
- ▶ **For the other terminals** To preselect the blade cassette, press the  key on the terminal, *see Page 138*.
 - ⇒ The key switches to .
- ▶ To lower the blade cassette, actuate and hold down the control unit in the tractor (yellow, 3-).
- ➔ The blade cassette moves into maintenance position: The blade cassette is lowered and the blades are swivelled out (deactivated).
- ➔ **For version with "Operation unit DS 100":** The warning lamp  below the key  is lit as soon as the blade cassette and the blades are in maintenance position.
- ➔ **For the remaining terminals:**  is lit in the status line as soon as the blade cassette and blades are in maintenance position.

NOTE! To lower the blade cassette, so that the maintenance position can be reached, do not move the control unit in the tractor into float position. When the control unit is put to floating position, only the blade cassette is lowered, the blades remain in the feed channel.



Lifting the blade cassette



When the blade cassette is raised, the blade cassette and blades are put into operation again. The number of blades set beforehand is swivelled in (activated).

- ▶ **For "Operation unit DS 100" version:** To preselect the blade cassette, press the  key, *see Page 108*.
 - ⇒ The indicator lamp below the key lights up.
- ▶ **For the other terminals** To preselect the blade cassette, press the  key on the terminal, *see Page 138*.

⇒ The key switches to .

- ▶ To raise the blade cassette, actuate and hold down the control unit in the tractor (yellow, 3+).
- ➔ The blade cassette is raised and the number of blades set beforehand is swivelled in (activated).

➔ **For version with "Operation unit DS 100":** The warning lamp  below the key  goes out as soon as the blade cassette has been raised and the number of blades set beforehand has been swivelled in.

➔ **For the remaining terminals:**  or  is lit in the status line as soon as the blade cassette has been raised and the number of blades set beforehand has been swivelled in.

8.12.2 Swivelling in/out blades

The blades can be swivelled in/out via the terminal and the tractor hydraulics without lowering the blade cassette.

Swivelling in (activating) blades



▶ **For "Operation unit DS 100" version:** To preselect the blades, press the  key.

⇒ The indicator lamp under the key is lit until the blades have been swivelled in.

▶ **For the other terminals:** To preselect the blades, press the  key.

⇒ The  key appears additionally on the display.

▶ Press the  key.

⇒ The  key is displayed with a green arrow  until the blades are swivelled in.

▶ To swivel in (activate) the blades, actuate and hold down the control unit in the tractor (yellow, 3+).

The following prompt to move the blades via the tractor hydraulics appears if the control unit is **not** pressed after approx. 3 seconds:

Icon	Explanation
522014-7 	Moving blades

For the "DS 100 operation unit" version: As soon as the blades are swivelled in (activated), the indicator lamp above the field above the key lights up as a status display.



All blade groups were swivelled out in the mechanical blade group control system if the indicator lamp above the field of the key does not shine, [see Page 91](#).

For the remaining terminals:  is lit in the status line as soon as the blades have been swivelled in (activated).



If  is displayed in the status line, all blade groups were swivelled out with the mechanical blade group control system, [see Page 91](#).

Swivelling out (deactivating) blades

► **For "Operation unit DS 100" version:** To preselect the blades, press the  key.
⇒ The indicator lamp under the key is lit until the blades have been swivelled out.

► **For the other terminals:** To preselect the blades, press the  key.
⇒ The  key appears additionally on the display.

► Press the  key.

⇒ The  key is displayed with a green arrow  until the blades are swivelled out.

► To swivel out (deactivate) the blades, actuate and hold down the control unit in the tractor (yellow, 3-).

The following prompt to move the blades via the tractor hydraulics appears if the control unit is **not** pressed after approx. 3 seconds:

Icon	Explanation
522014-7 	Moving blades

For "DS 100 operation unit" version: As a status display, the indicator lamp does not shine above the field above the key as soon as the blades are swivelled out (deactivated).

For the remaining terminals:  is lit in the status line as soon as the blades have been swivelled out (deactivated).

8.12.3 Swivelling blade groups in/out

The blades of the cutting unit can be individually swivelled in or out in 2 groups or both groups can be completely swivelled in or out. The number of blades used determines the cutting length of the crops, [see Page 205](#).

- ✓ The pick-up is fully raised in transport position, [see Page 84](#).
- ✓ The blades have been swivelled out (inactive), [see Page 90](#).
- ✓ The machine has been shut down and secured, [see Page 28](#).

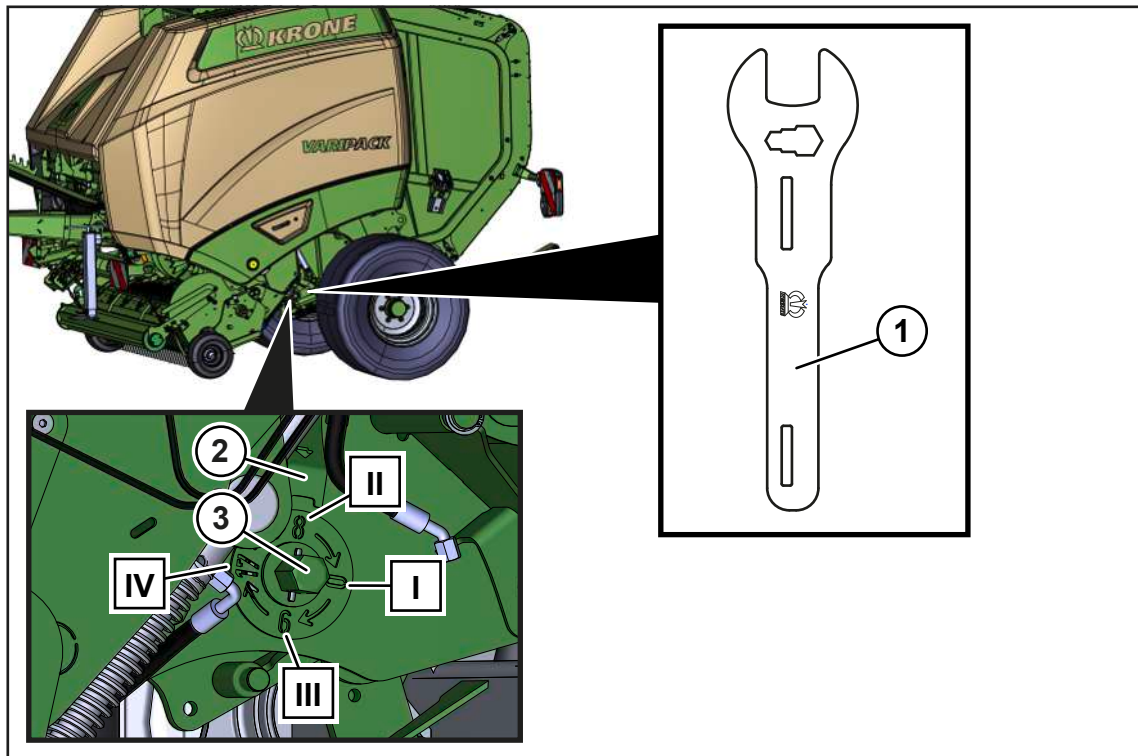

RP000-802

Position	Explanation
I	0 blades
II	8 blades as a group
III	9 blades as a group
IV	17 blades

- ▶ Remove the maintenance key (1) which is attached near the blade cassette.
- ▶ Using the maintenance key (1), rotate the blade control shaft (3) in the direction of the arrow into the required position.
- ▶ Ensure that the pointer (2) is pointing towards the required position.
- ➔ 8 blades are illustrated here.

If individual blades did not swivel in

The following steps must be performed if individual blades did not swivel in after the blade groups were mechanically or hydraulically swivelled in.

Move the blades and the blade cassette into the maintenance position as follows:

- ▶ **For "Operation unit DS 100" version:** To preselect the blade cassette, press the  key, [see Page 108](#).

⇒ The indicator lamp below the key lights up.

- ▶ **For the other terminals** To preselect the blade cassette, press the  key on the terminal, *see Page 138*.

⇒ The key changes to .

- ▶ To lower the blade cassette, actuate the control unit on the tractor (yellow, 3-).
- ➔ The blades and blade cassette are in maintenance position: The blades have been swivelled out and the blade cassette has been lowered.

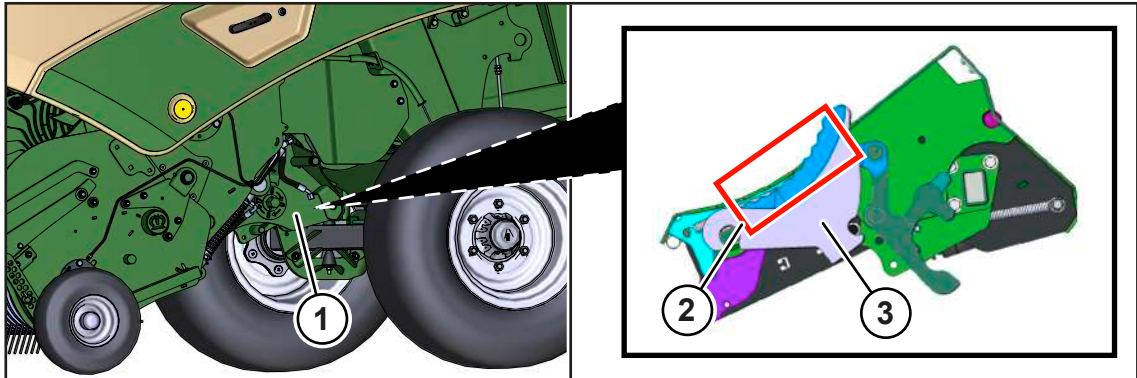

RPG000-154

- ✓ The tailgate is open and secured with the stop cock, *see Page 105*.
- ✓ The machine has been shut down and secured, *see Page 28*.
- ▶ Clean the blades (3) and the blade cassette (1) from the rear side of the machine. In particular, clean the area (2) on the cutting edge of the blade (3).
- ▶ Swivel the blade groups back into the working position.
- ▶ If required, move individual blades, which have not swivelled in, into the working position using a suitable tool, e.g. a plastic hammer, by tapping the back of the blade.

8.12.4 Storing blades on the blade support

The blade support on the left and/or right side of the machine is used to suspend a set of blades for storage. Here, you can store either the new or the used set of blades.

For "Blade support left" version, for "Blade support right" version

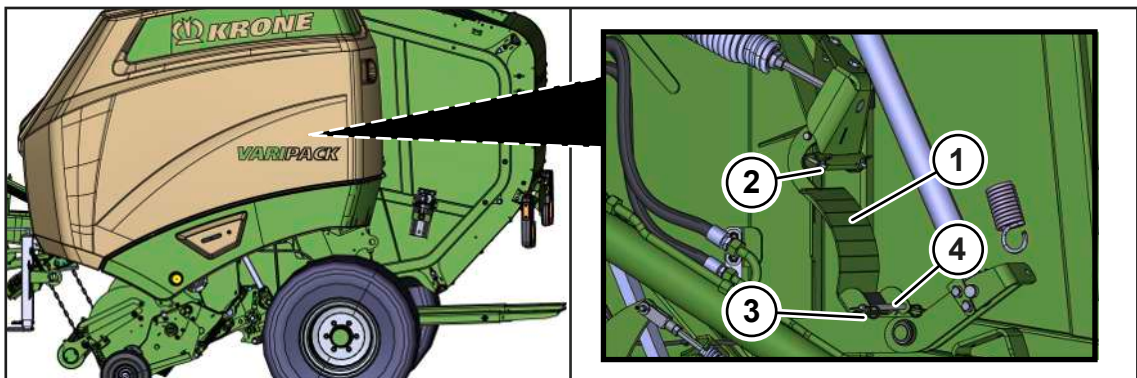

RPG001-242

The blade support (1) sits on the left or right side of the machine, under the side hood. Here, the blade support (1) is shown on the left-hand side as an example.

- ✓ The machine has been shut down and secured, [see Page 28](#).
- ▶ Remove the linch pin (2).
- ▶ Dismount the bolt (4) and the spring cotter pin (3).
- ▶ Push the blades onto the blade support (1) for storage.
- ▶ Mount the bolt (4) and secure it by means of the spring cotter pin (3).
- ▶ Mount the linch pin (2).

8.13 Net wrapping

8.13.1 Inserting the net roll

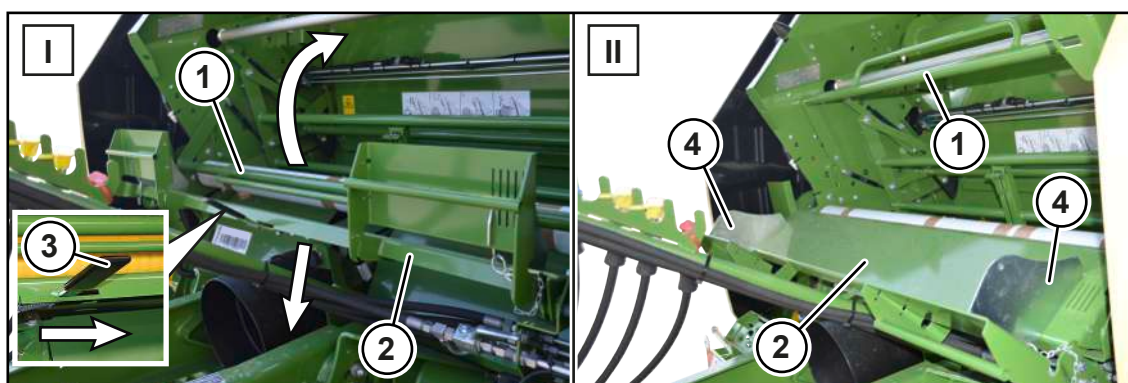

RP000-722

Position	Explanation
Position (I)	The pressure pipe (1) and the net support / holder (2) have been folded in.
Position (II)	The pressure pipe (1) and the net support / holder (2) have been folded out. A net roll can be inserted.

- ✓ The machine has been shut down and secured, [see Page 28](#).
- ▶ Using the handle, fold the pressure pipe (1) upwards in the direction of the arrow.
- ▶ To release the net support / holder (2), move the lever (3) to the right in the direction of the arrow.
- ▶ At the same time fold the net support / holder (2) downwards in the direction of the arrow.
- ▶ Dismount one of the two alignment sheets (4) to make it easier to insert the net roll in the next step.

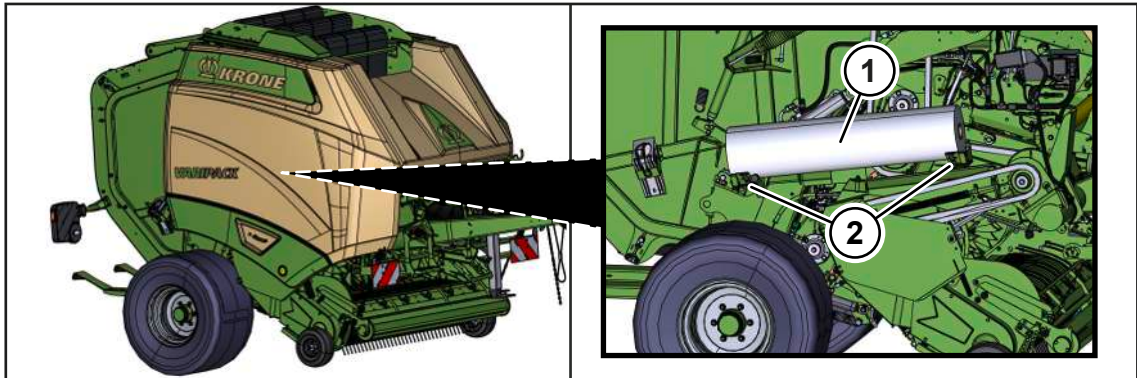

RPG001-243

On the right and left side of the machine there is a net roll support behind the side hood. This support can be used to stow a net roll (1) in the packaging.

The net roll (1) is secured with the straps (2).

- ▶ Lift the net roll (1) off the net roll support and lean it on the right or left side on the net holder.
- ▶ Stow the straps (2) on the net roll support such that they cannot get into machine movements.

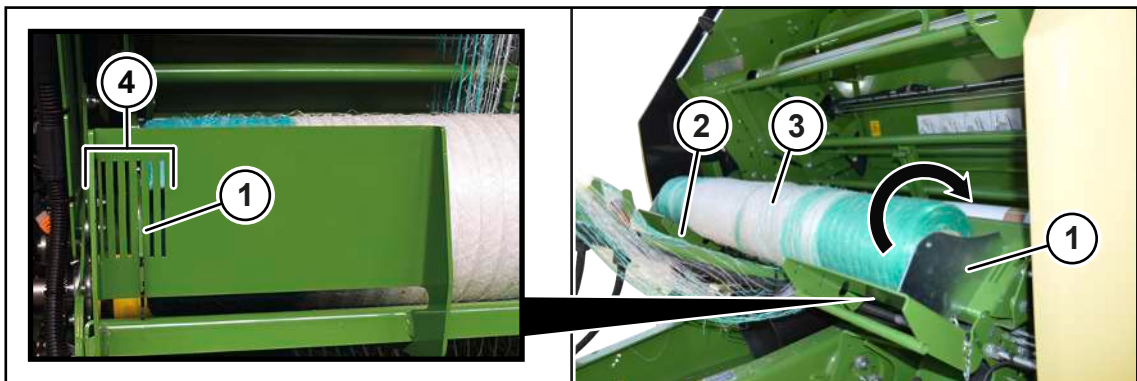

RP000-723

- ▶ Slip the net roll (3) sideways on the net holder (2).
- ▶ Ensure that the net roll (3) rotates in the direction of the arrow and can be pulled out from below as illustrated.
- ▶ To centre the net roll (3), insert the alignment sheets (1) identically on both sides of the net support / holder (2). Ensure that a gap of approx. **2 mm** is maintained on both sides between the net roll (3) and alignment sheet (1).

INFO

Ensure that the net holder (2) is folded up again after the net has been loaded. This is described in the next chapter, [see Page 97](#).

8.13.2 Inserting the net

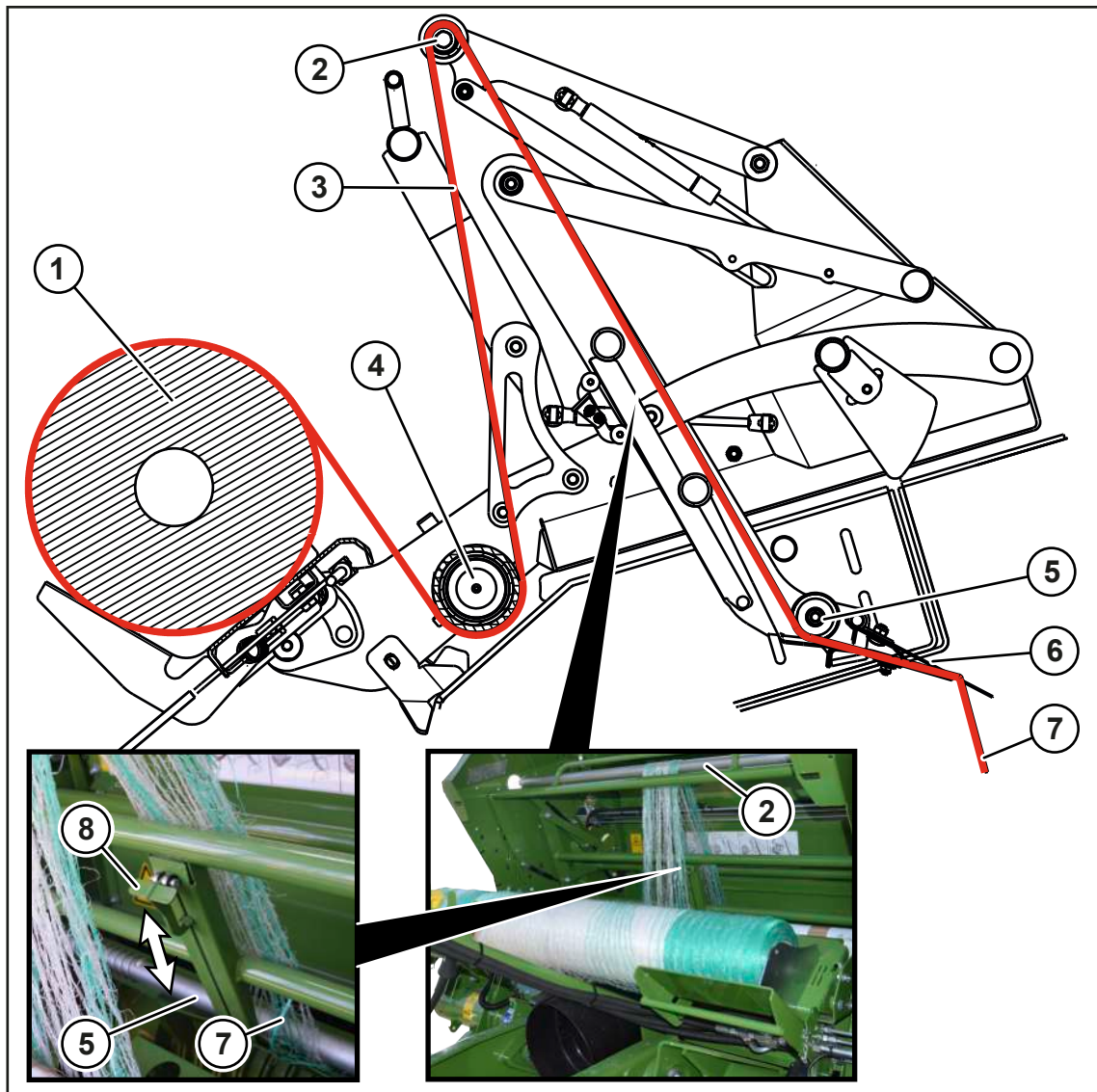

RP000-724

The net path (3) is shown in red on the drawing.

- ✓ The machine has been shut down and secured, [see Page 28](#).
- ▶ Unwind approx. 2 metres forwards off the net roll (1).
- ▶ Route the net under the yellow rubber roll (4).
- ▶ Place the net over the deflection roll (2).
- ▶ Place the end of the net (7) between the spreading roll (5) and net pusher (8).

INFO

A length of approx. 2 metres is reached when the net is pulled upwards off the net roll as far as the opened front hood and back.

To make it easier to thread the net, you can tie a knot in the end of the net.

Folding back net support / holder

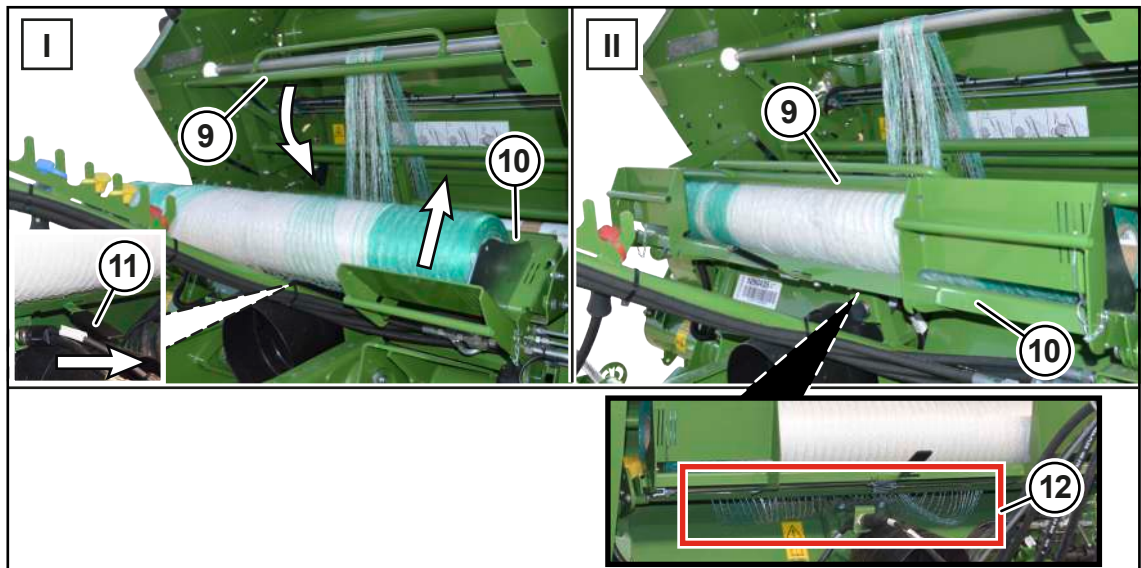

RP000-946

Position	Explanation
Position (I)	The pressure pipe (9) and the net support / holder (10) for insertion of the net have been folded out.
Position (II)	The pressure pipe (9) and the net support / holder (10) have been folded in. When the net roll and the net have been completely inserted, the tying system is now ready for operation.

- ▶ To release the net support / holder (10), move the lever (11) to the right.
- ▶ At the same time fold the net support / holder (10) upwards in the direction of the arrow.

Actuating the net pusher (8)

- ▶ Move the net pusher (8) several times up and down in the direction of the arrow so that the net is pushed under the spreading roll (5).
- ▶ Ensure that approx. **10 cm** of the net protrudes between the rubber pads (6).
- ▶ After the last pushing movement, push the net pusher (8) back into the upper position.

If there is still net under the net roll

This surplus net is shown in the area (12).

- ▶ Roll the net back onto the net roll and lightly tension the net.

WARNING! Risk of injury to fingers! Always use the handle to move the pressure pipe (9)!

- ▶ Using the handle, fold the pressure pipe (9) downwards in the direction of the arrow onto the inserted net roll.

8.13.3 Cutting the net

For version with "Pivoted wrapping and tying material supply"

If the start of the net roll is damaged, this damaged part must be cut off. The installed blades on the machine can be used for this purpose.

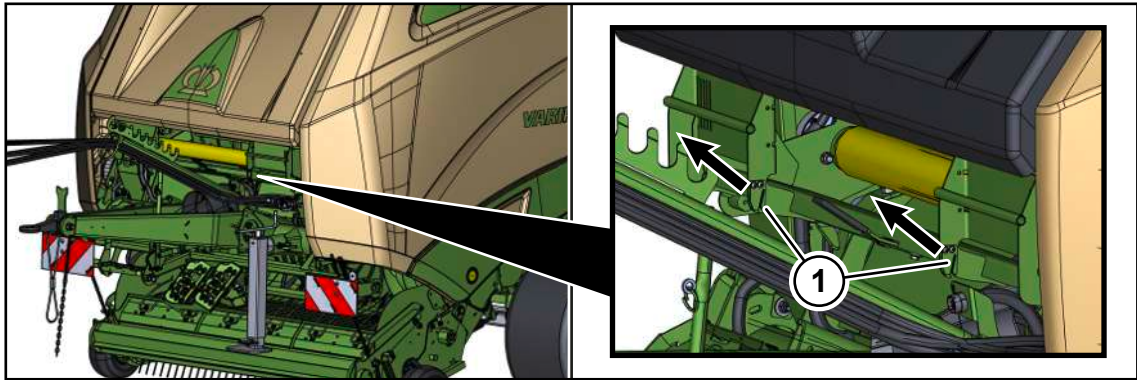

RPG000-188

- ✓ The machine has been shut down and secured, [see Page 28](#).
- ▶ Place the net in the notches (1) and pull the net in the direction of the arrow.
- ➔ The net is cut off by the installed blades in the notches (1).
- ▶ Dispose of the net remainders properly.

8.13.4 Using pivoted wrapping and tying material supply

For version with "Pivoted wrapping and tying material supply"

Fitting pivoted wrapping and tying material supply

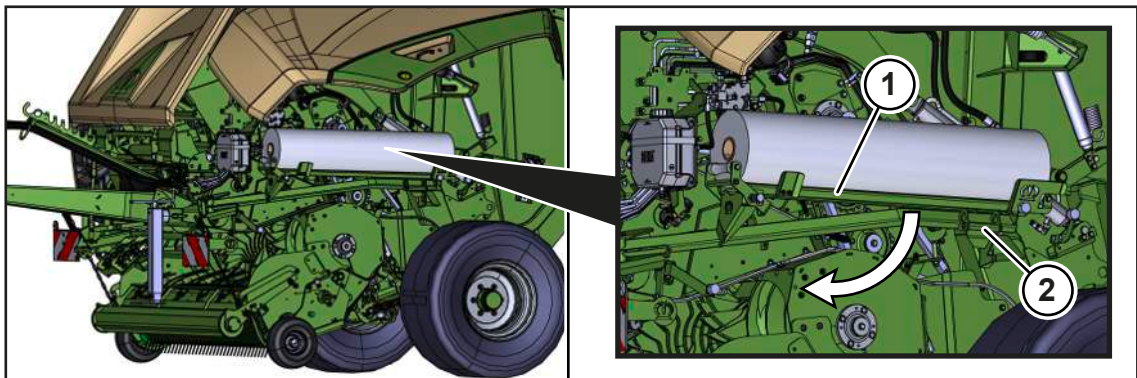

RPG000-166

A new net roll can be entrained during operation on the pivoted wrapping and tying material supply (1) on the left side of the machine under the side hood. The net roll can be placed on the pivoted wrapping and tying material supply with little effort.

- ✓ The machine has been shut down and secured, [see Page 28](#).
- ✓ The left side hood is open.
- ▶ Pull the handle (2) and manually guide pivoting storage container for wrapping material (1) and swivel out to the side.

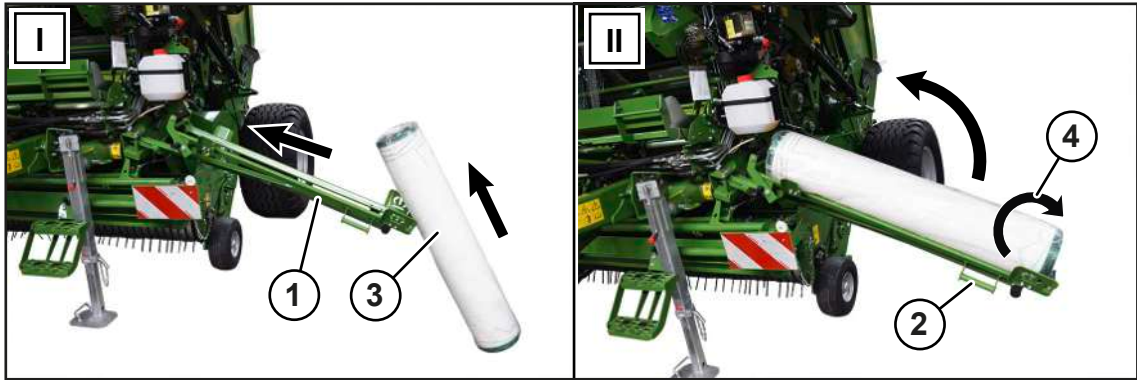

RPG000-262

- ▶ Lean a new net roll (3), including protective sleeve, on the storage container for wrapping material (1) swivelled out to the side (Position I).
- ▶ Ensure that the net roll was rotated in the correct direction (4).
- ▶ Push the net roll (3) in the direction of the arrow onto the wrapping and tying material supply (1) (Position II).
- ▶ Using the handle (2), manually guide the storage container for wrapping material (1) and swivel back onto the machine.

Changing the net roll

The new net roll can be pushed with little effort from the pivoted wrapping and tying material supply onto the net support / holder on the tying system.

Beforehand prepare the net support / holder on the tying system as follows:

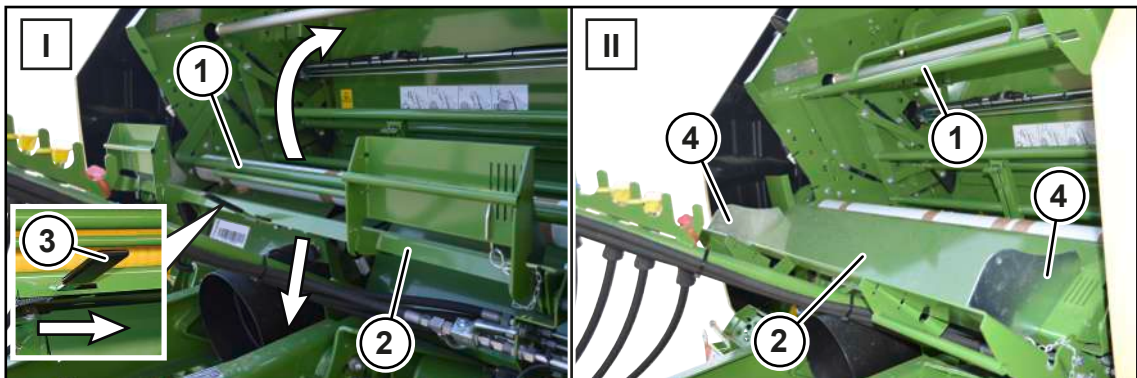

RP000-722

Position	Explanation
Position (I)	The pressure pipe (1) and the net support / holder (2) have been folded in.
Position (II)	The pressure pipe (1) and the net support / holder (2) have been folded out. A net roll can be inserted.

- ✓ The machine has been shut down and secured, [see Page 28](#).
- ▶ Using the handle, fold the pressure pipe (1) upwards in the direction of the arrow.
- ▶ To release the net support / holder (2), move the lever (3) to the right in the direction of the arrow.
- ▶ At the same time fold the net support / holder (2) downwards in the direction of the arrow.
- ▶ Dismount one of the two alignment sheets (4) to make it easier to insert the net roll in the next step.

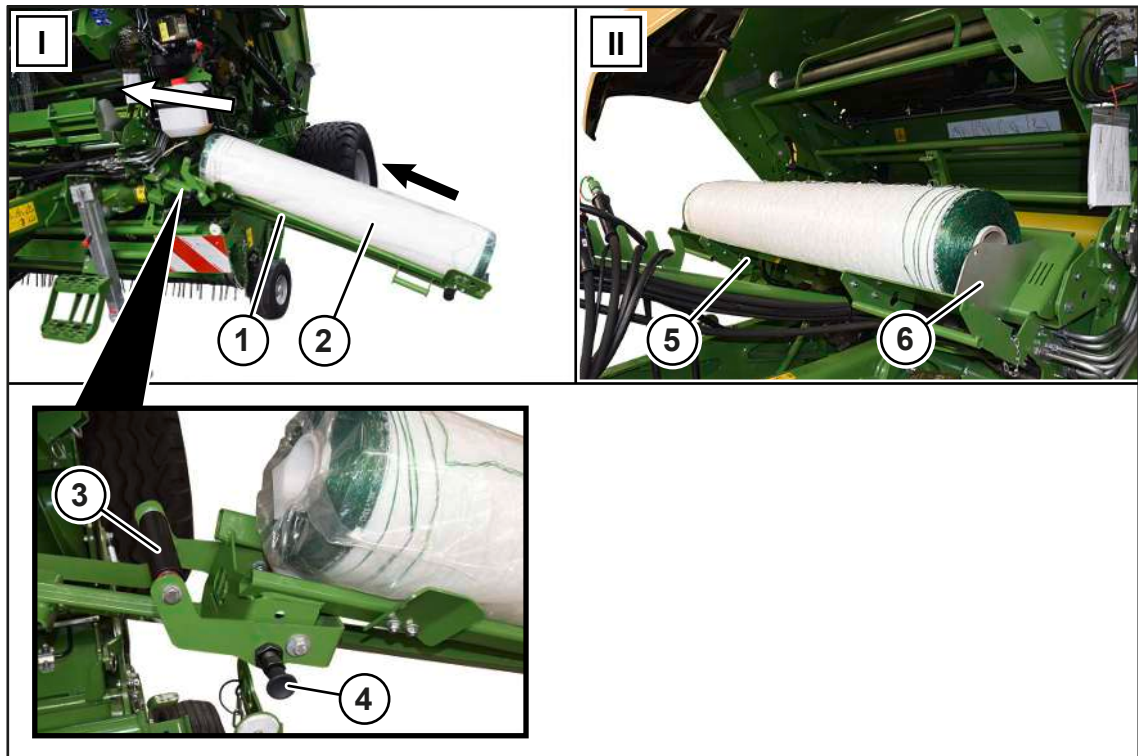

RP000-829

- ✓ The pivoted wrapping and tying material supply (1) with the new net roll (2) has been swivelled out to the side (Position I).
- ▶ Pull the knob (4) and swivel the retaining clip (3) downwards.
- ▶ Dismount the alignment sheet (6) from the net support / holder (5).
- ▶ Push the net roll (2) in the direction of the arrow onto the net support / holder (5) (Position II).

For the following steps for inserting the net roll and for inserting the net, [see Page 94](#) and [see Page 96](#).

8.14 Twine tying

For the "Net wrapping and twine tying" version

8.14.1 Connecting spools of twine with each other

NOTICE

Damage to the machine due to soiling of the components of twine tying system

If the twine or components of the twine tying are soiled by oil or lubricating grease, the machine may suffer damage.

- ▶ Cut off any soiled section of twine or use a new twine spool.
- ▶ Clean the components of the twine tying before inserting the twine.

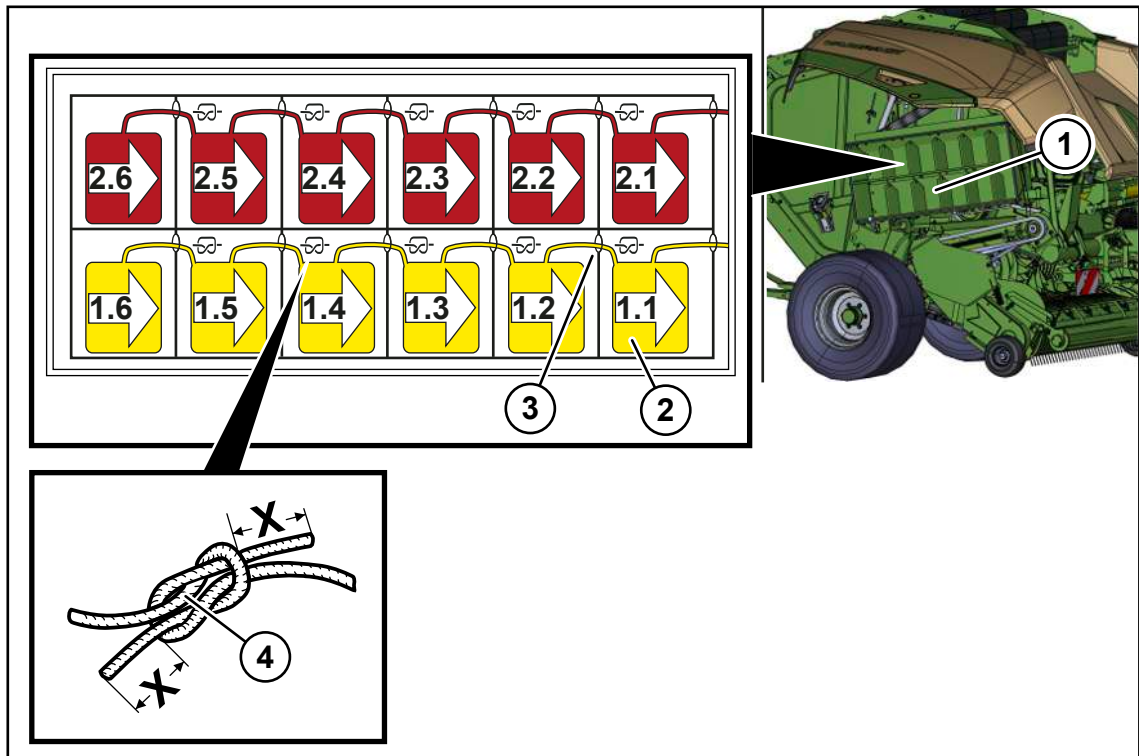

RPG000-201

Producing tying twines 1 and 2

The twine tying system of the machine works with 2 tying twines which are tied around the round bale. Before the tying twines are inserted into the machine, the spools of twine (2) in the twine storage box (1) are knotted together in the following way.

- ✓ The machine has been shut down and secured, [see Page 28](#).
- ✓ The right side hood is open.
- ▶ Thread the twine front end of spool of twine 1.6/2.6 through the lateral eyelet (3) and connect it with a reef knot (4) to the twine end of spool of twine 1.5/2.5.
- ▶ Using the same procedure (see figure above), also connect the adjacent spools of twine.
- ▶ Lead the twine front end of spool of twine 1.1/2.1 through the lateral eyelet (3) out of the twine storage box (1).
- ▶ Shorten the twine ends of all reef knots to **X=15 ... 20 mm**.

8.14.2 Inserting tying twine

- ✓ The machine has been shut down and secured, [see Page 28](#).
- ✓ The spools of twine are connected with each other in the twine box, [see Page 100](#).

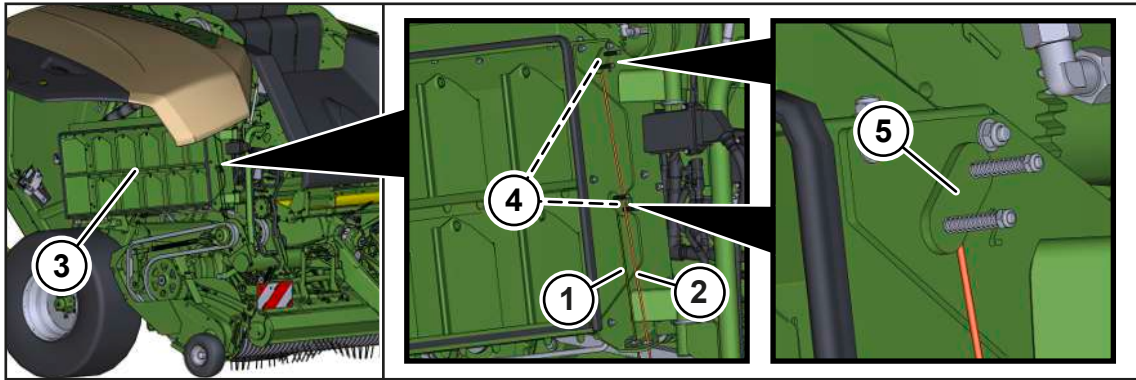

RP001-027

The tying twines (1) and (2) are coloured in the figures below:

- Yellow: Bottom tying twine (1) from the bottom row of the twine box
- Red: Top tying twine (2) from the top row of the twine box
- ▶ Using your fingers, loosen the spring plates (5) slightly so that the tying twines can be threaded through them.
- ▶ Route the tying twines (1) and (2) through the eyelets (4) out of the twine box (3) to the outside.

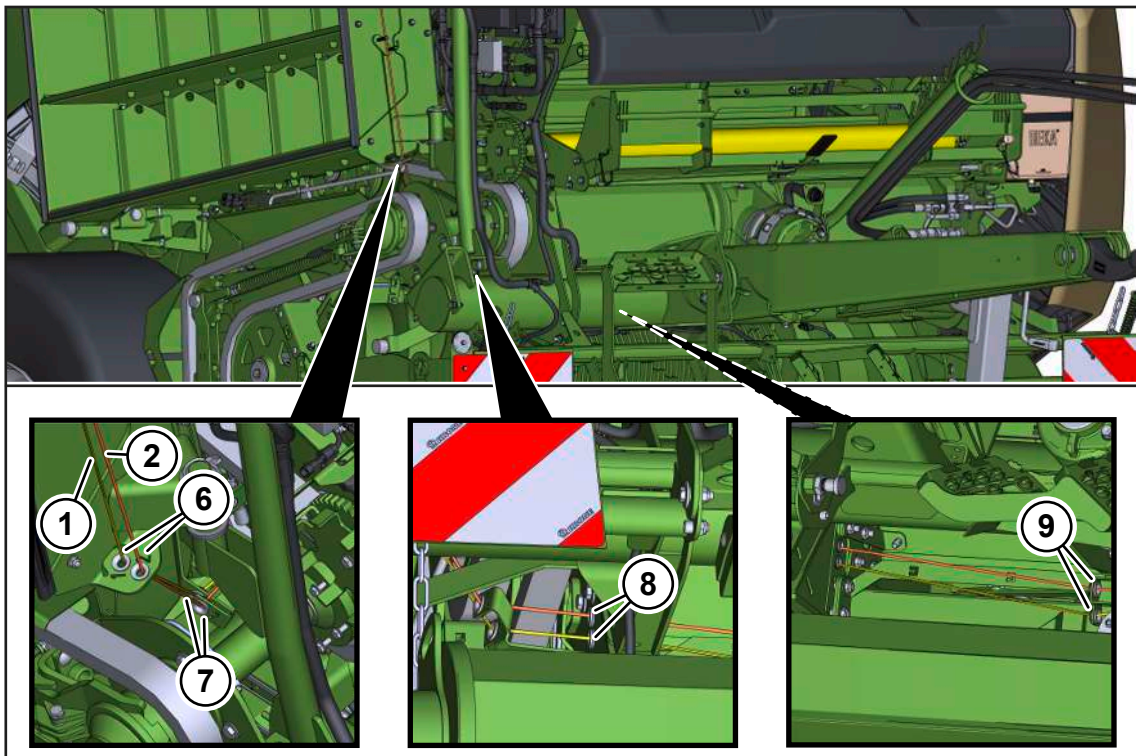

RP001-028

- ▶ Route the tying twines (1) and (2) through the eyelets (6), (7), (8) and (9).

For assistance, the eyelets on the machine are marked with 1 and 2.

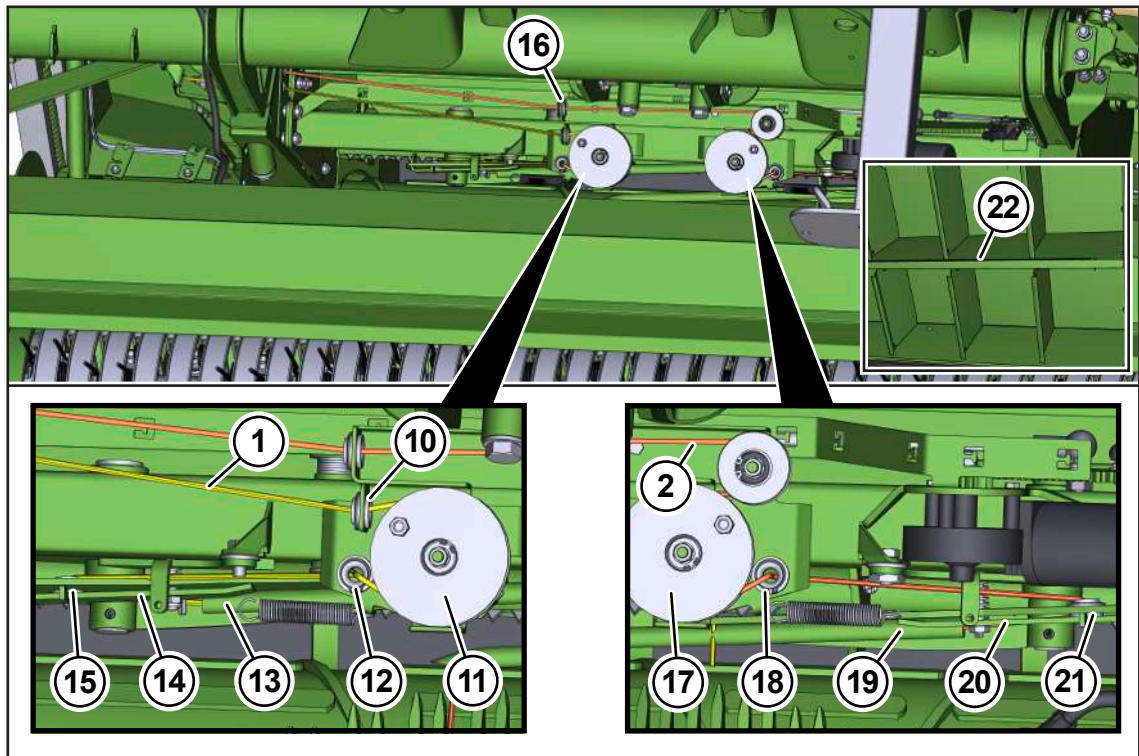

RP001-034

In the twine box on the left side of the machine there is a movable spring (22) which can be removed in order to guide the twine (1) more easily through the guide tubes (13) and (19).

Bottom tying twine (1)

- ▶ After the eyelet (10), route the tying twine (1) around the sensor roll (11) and through the eyelet (12).
- ▶ Swivel the brake plate of the twine brake (14) to the side.
- ▶ Thread the tying twine (1) from above through the eyelet (15).
- ▶ Using the spring (22), route the twine (1) through the guide tube (13) to the centre of the machine, leaving about 15 cm overhang at the end.
- ▶ Put the brake sheet of the twine brake (14) back onto the eyelet (15), so that the twine (1) is pinched.

Top twine (2)

- ▶ After the eyelet (16), route the tying twine (2) around the sensor roll (17) and through the eyelet (18).
- ▶ Swivel the brake plate of the twine brake (20) to the side.
- ▶ Thread the tying twine (2) from above through the eyelet (21).
- ▶ Using the spring (22), route the twine (2) through the guide tube (19) to the centre of the machine, leaving about 15 cm overhang at the end.
- ▶ Put the brake sheet of the twine brake (20) back onto the eyelet (21), so that the twine (2) is pinched.

To adjust the twine tension on the twine brake [see Page 202](#).

8.14.3 Swivelling the twine box to and fro

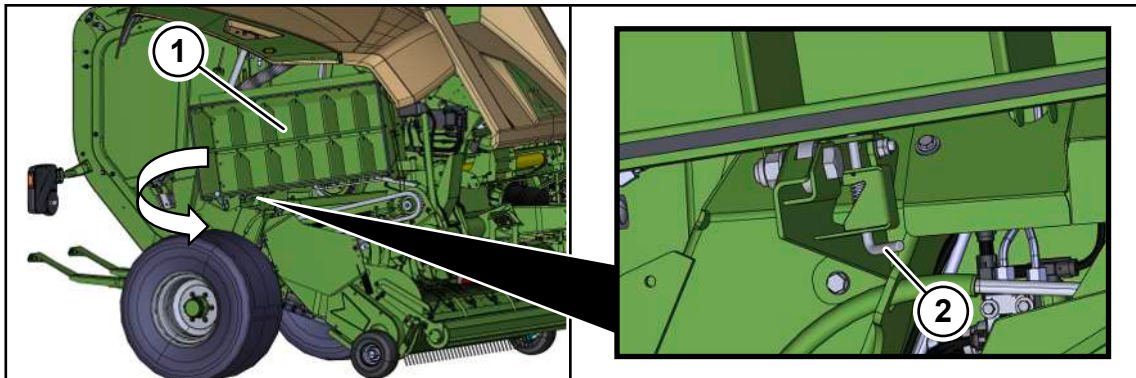

RPG000-202

The twine box (1) sits on the right side of the machine. To carry out maintenance and adjustment work on the right-hand side of the machine, you can swivel the twine box (1) forward.

- ✓ The machine has been shut down and secured, [see Page 28](#).
- ▶ To swivel the twine box (1) forward, pull and turn the unlocking handle (2) so that it locks.

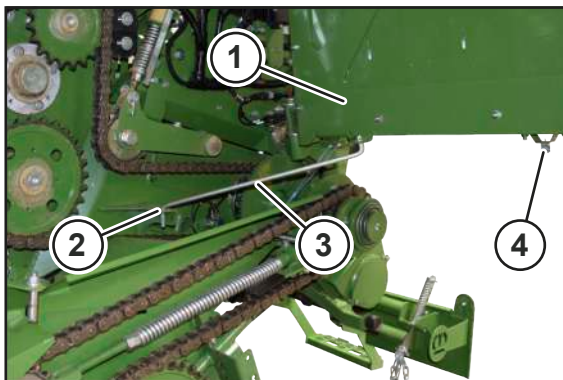

RP001-032

- ▶ To secure the twine box (1) in the unfolded position, insert the wire bracket (3) from the mounting bracket (4) into the borehole (2).

8.15 Open/close tailgate

WARNING

Risk of injury due to unpredictable movement of the round bales when the machine is operating on a slope

If round bales are deposited on a slope, they may start moving on their own. Once round bales have started moving, their weight and cylindrical shape may cause serious accidents and injure people.

- ▶ On slopes, deposit round bales in manual mode only.
 - ▶ On slopes, always deposit round bales in such a way that they cannot start moving on their own.
-
- ▶ To open the tailgate, actuate the control unit on the tractor (red, 1+) until the tailgate is open.
 - ▶ To close the tailgate, move the control unit on the tractor (red, 1+) into the float position.

8.16 Using the stop cock of the tailgate

 **WARNING**

Risk of injury if the stop cock of the tailgate is opened

When working on or underneath the opened tailgate or inside the bale chamber, the tailgate may drop down in an uncontrolled manner if the stop cock is opened. As a result, people may be seriously injured or killed.

- ▶ Always close the stop cock when carrying out work with the tailgate open.

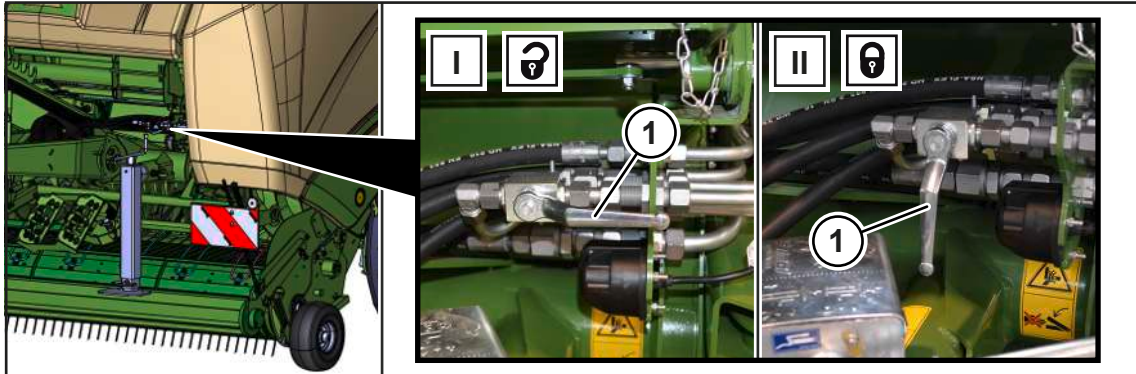

RPG000-014

The tractor supplies the machine hydraulics via hydraulic hoses. The tailgate stop cock (1) is a safety component which prevents the tailgate from unintentionally closing. The tailgate stop cock (1) must be closed if working in the bale chamber or on the tailgate.

The tailgate stop cock (1) is located at the front of the machine near the support jack.

- ✓ The machine has been shut down and secured, [see Page 28](#).

Opening the stop cock

- ▶ Turn the stop cock (1) into position (I).
- ➔ The tailgate can be closed.

Closing the stop cock

- ▶ Turn the stop cock (1) into position (II).
- ➔ The tailgate cannot be closed.

8.17 Removing crop blockages

8.17.1 Crop blockage at the right-hand and left-hand end of the pick-up

- ▶ Lower the rotational speed.
- ▶ While the PTO shaft is running, reverse and actuate the control unit in the tractor (yellow, 3+) several times to lift and lower the pick-up.
- ▶ Ensure that the crop press roller unit does not collide with the chassis when raised.

If this does not remove the crop blockage:

- ▶ Shut down and safeguard the machine, [see Page 28](#).

CAUTION! Risk of injury due to sharp parts! Always wear appropriate protective gloves when removing crop blockages.

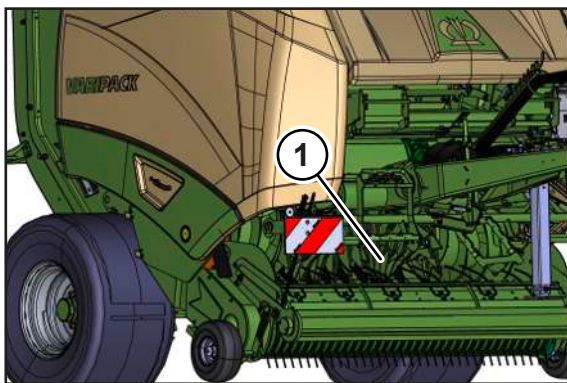

- ▶ Remove the accumulated crops manually.
- ▶ After remedying the crop blockage, increase the speed to the rated speed again.
- ▶ Resume baling.

8.17.2 Crop blockage under the cutting rotor



RPG000-164

To remove the accumulated crops from under the cutting rotor (1), proceed as follows:

- ▶ Switch off the PTO shaft.
- ▶ Reverse.
- ▶ Ensure that the tractor is in straight alignment with the machine.
- ▶ **For "Operation unit DS 100" version:** To preselect the blade cassette, press the  key, [see Page 108](#).
 - ⇒ The indicator lamp below the key lights up.
- ▶ **For the other terminals** To preselect the blade cassette, press the  key on the terminal, [see Page 138](#).
 - ⇒ The key changes to .
- ▶ To lower the blade cassette, actuate the control unit on the tractor (yellow, 3-).
- ▶ The blades and blade cassette are in maintenance position: The blades have been swivelled out and the blade cassette has been lowered.
- ▶ Switch on the PTO shaft and test at idling speed whether the crop blockage is being removed.

If this does not remove the crop blockage:

- ▶ Shut down and safeguard the machine, [see Page 28](#).

CAUTION! Risk of injury due to sharp parts! Always wear appropriate protective gloves when removing crop blockages.

- ▶ Manually remove the accumulated crops.

When the crop blockage has been removed, put the cutting unit back into operation as follows:

- ▶ Switch on the PTO shaft.
- ▶ Hydraulically raise the blade cassette, [see Page 88](#).
 - ⇒ The blade cassette is raised.
- ▶ Resume baling.

8.17.3 Crop blockage in the baling element

- ▶ Switch on the PTO shaft.
- ▶ Open the tailgate.
- ▶ Shut down and safeguard the machine, [see Page 28](#).
- ▶ Close the stop cock, [see Page 105](#).

CAUTION! Risk of injury due to sharp parts! Always wear appropriate protective gloves when removing crop blockages.

- ▶ Manually remove the accumulated crops from the baling element.
- ▶ Open the stop cock, [see Page 105](#).
- ▶ Switch on the tractor engine and the PTO shaft.
- ▶ Close the tailgate.
- ▶ Resume baling.

9 KRONE operation unit DS 100

For version with "Net wrapping"

NOTICE







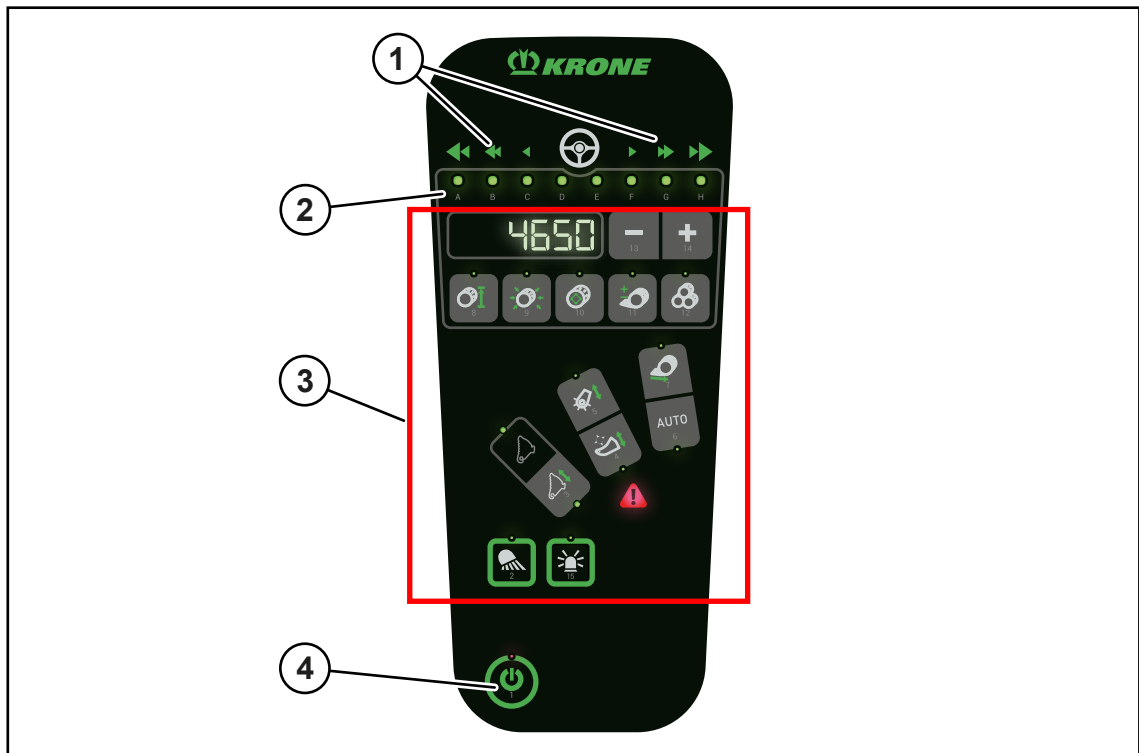

Penetration of water in the operation unit could lead to malfunction. As a result, the machine can no longer be operated safely.

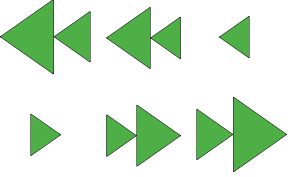



- ▶ Protect the operation unit from water.
- ▶ If the machine is not used for an extended period of time (for example in winter), the terminal must be stored in a dry place.
- ▶ For installation and repair work, especially for welding jobs on the machine, interrupt the voltage supply to the operation unit.

9.1 Overview

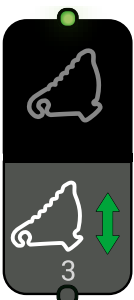
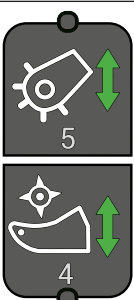

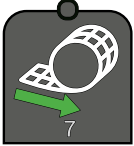
EQ003-241

Pos.	Icon/designation	Explanation
1		Direction display arrows, see Page 111
2	LEDs A-H	The LEDs indicate the direction or the progress of the tying cycle on the working screen. Additionally, the LEDs can indicate different settings.
3		Display for various indications and settings
		Various settings can be made via the Plus and Minus keys.
		<ul style="list-style-type: none"> Setting the bale diameter, see Page 113 Setting advance signaling, see Page 114 Setting the sensitivity of direction display, see Page 115
		Setting the baling pressure, see Page 115
		Setting the density and diameter of the bale core, see Page 116
		<ul style="list-style-type: none"> Setting the number of net layers, see Page 119 Setting the tying start delay, see Page 119
		Display customer counter, see Page 120
		<p>Preselect blades to be able to lift/lower the blades via the control unit, see Page 90.</p> <p>There is an indicator lamp above the key which is lit when the blades have been swivelled in.</p> <p>The indicator lamp below the key lights up as long as the blades can be swivelled in/out without lowering the blade cassette.</p>
		<ul style="list-style-type: none"> Preselect pick-up to be able to move pick-up into transport/working position via the control unit, see Page 84 Preselect blade cassette to be able to lift/lower the blade cassette via the control unit, see Page 88

Pos.	Icon/designation	Explanation
	 	<ul style="list-style-type: none"> Start tying process in manual mode Switch the automatic mode of tying on/off, see Page 112
		Switching working lights on/off, see Page 113
		Switching warning beacon on/off, see Page 113
4		Switching the operation unit on/off, see Page 110

9.2 Switching the operation unit on/off

When the operation unit is connected to the power supply of the tractor, the operation unit is switched on automatically. For connecting the operation unit, [see Page 66](#).

When the operation unit is switched on:

- All indicator lamps and the background lighting emit light briefly and an acoustic signal is sounded.
- If an indicator lamp does not light up, this lamp is defective.
- The operation unit is ready for operation and is in road travel screen mode.

INFO

If another terminal is connected to the machine and a function is enabled on this terminal which the DS 100 operation unit cannot show on the display, it is no longer possible to press the keys on the DS 100 operation unit. The indicator lamp above the  key flashes.

► To exit this state, press the  key and hold for approx. 1 second.

⇒ The operation unit is in road travel screen mode.

9.3 Call road travel screen

After the operation unit is switched on, it is in road travel screen mode. In road travel screen mode, only the indicator lamp above the  key emits light.

- To change from working screen to road travel screen, press the  key and hold for approx. 1 second.

9.4 Accessing the working screen

The working screen can show the following data:

- The display shows the actual bale diameter in cm.
- During filling of the bale chamber, the LEDs A-H serve as direction display, [see Page 111](#).
- During the tying cycle, the LEDs A-H show the process of the tying.

- ▶ To change from road travel screen to working screen, press the  key.





9.5 Direction display





EQ003-242



The direction display (1) shows the driver to which side and to what extent he must correct his direction when driving over the swath in order to ensure the bale chamber is filled evenly.

The LEDs below the icons emit light to indicate the direction of travel. The icons have the following meaning:

Icon	Explanation
 LED C/D	Step 1: The bale chamber is filled slightly too much on the left side. Steer the tractor to the left to pick up the swath on the right of the bale chamber.
 LED B/C	Step 2: The bale chamber is filled too much on the left side. Steer the tractor to the left to pick up the swath on the right of the bale chamber.
 LED A/B	Step 3: The bale chamber is filled very heavily on the left side. Steer the tractor to the left to pick up the swath on the right of the bale chamber.
 LED A	Step 4: The bale chamber is filled very heavily on the left side. Steer the tractor to the left to pick up the swath on the right of the bale chamber.
LED D/E	Swath is picked up in the middle
 LED E/F	Step 1: The bale chamber is filled slightly too much on the right side. Steer the tractor to the right to pick up the swath on the left of the bale chamber.

Icon	Explanation
 LED F/G	Step 2: The bale chamber is filled too much on the right side. Steer the tractor to the right to pick up the swath on the left of the bale chamber.
 LED G/H	Step 3: The bale chamber is filled very heavily on the right side. Steer the tractor to the right to pick up the swath on the left of the bale chamber.
 LED H	Step 4: The bale chamber is filled very heavily on the right side. Steer the tractor to the right to pick up the swath on the left of the bale chamber.

How the bale chamber is optimally filled by the pick-up, [see Page 77](#).

- ▶ If the swath is the same width as the bale chamber, pick up the swath as centrally as possible.
 - ⇒ The D and E LEDs light up.
- ▶ If the swath is too narrow, pick it up alternately on the left and right sides. Ensure that you do not move too far to the left  or right .



9.6 Start tying

Start tying process in manual mode

Once the bale chamber has been filled, the indicator lamp above the  key flashes, and the tying cycle can be started manually.



- ▶ To start the tying cycle, press the  key.
- ➔ The indicator lamp above the key emits light. The LEDs A-H indicate the progress of the tying cycle.

Switching automatic tying on/off

- ▶ To switch automatic tying on, press the  key.
- ➔ The indicator lamp under the key lights up. The next tying cycles are started as soon as the set bale chamber filling level is reached.
- ▶ To switch automatic tying off, press the  key.
- ➔ The indicator lamp below the key goes out. The next tying cycles must be started manually via the  key.



9.7 Switching the working lights on/off

For "Working lights" version

- ▶ To switch on the working lights, press the  key.
- ➔ The indicator lamp above the key emits light.
- ▶ To switch off the working lights, press the  key.
- ➔ The indicator lamp above the key goes out.

9.8 Switching warning beacon on/off

For "Warning beacon" version



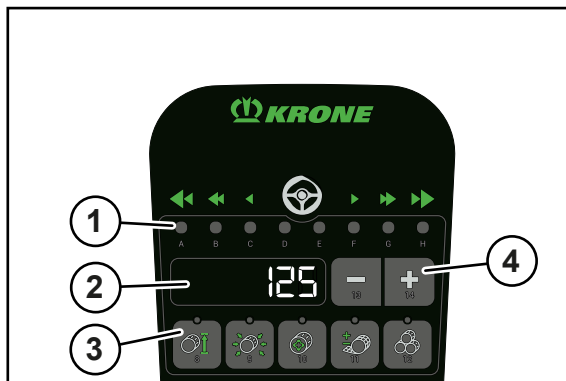

- ▶ To switch on the warning beacon, press the  key.
- ➔ The indicator lamp above the key emits light.
- ▶ To switch off the warning beacon, press the  key.
- ➔ The indicator lamp above the key goes out.

9.9 Setting the bale diameter



EQG003-119

In the working screen, the bale diameter for the entire round bale in cm can be set at the operation unit.

- ▶ Press the  key (3) to call the "Bale diameter" menu.
- ➔ The indicator lamp above the  key and the LED A (1) emit light.
- ➔ The display (2) shows the set target bale diameter in cm.
- ▶ To change the value, press the   keys (4).
- ➔ The value is saved automatically.
- ▶ To return to the working screen, press the  key (3) again.

To set a separate diameter for the core of the round bale, [see Page 116](#).





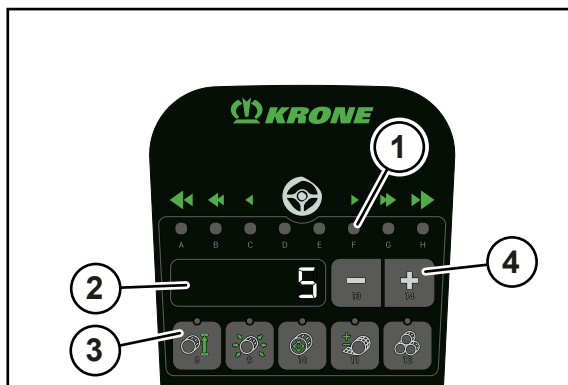

9.10 Setting advance signaling

Pre-signaling is used to warn if the round bale in the bale chamber is near completion. On the operation unit, you can set the filling at which advance signaling starts.



EQG003-117

On the operation unit, advance signaling can be set in cm on the working screen.

- ▶ To call the "Pre-signaling" menu, first press the  key (3) and then the  key once.
 - ⇒ The indicator lamp above the  key and the LED F (1) emit light.
 - ⇒ The display (2) shows the set cm value for pre-signaling.
- ▶ To change the value, press the   keys (4).
- ➔ The value is saved automatically.
- ▶ To return to the working screen, press the  key (3) again.

9.11 Setting the sensitivity of the direction display

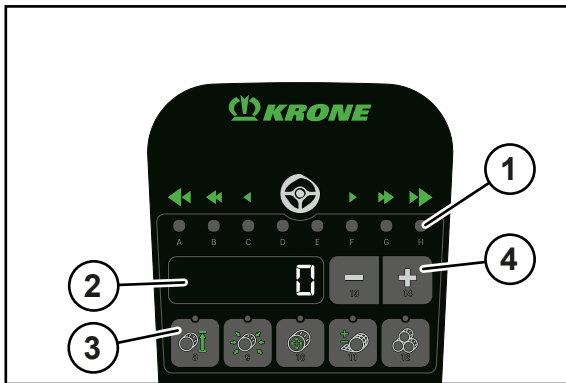



EQG003-118



This menu is used to set the sensitivity of the direction display on the working screen.

The direction display indicates whether the swath is picked up in the centre by the pick-up and provides information about the required direction of travel. The higher the number on the display (2), the more sensitive the direction display is set. The higher the sensitivity of the direction display is set, the stronger the motion indication appears in the form of arrows on the working screen.

How the bale chamber is optimally filled by the pick-up, [see Page 77](#).

- ▶ To call the "Sensitivity of direction display" menu, first press the  key (3) and then the  key twice.

- ⇒ The indicator lamp above the  key and the LED H (1) emit light.
- ⇒ The display (2) shows the set sensitivity of the direction display.

- ▶ To change the value, press the   keys (4).
- ➔ The value is saved automatically.
- ▶ To return to the working screen, press the  key (3) again.

9.12 Setting the baling pressure

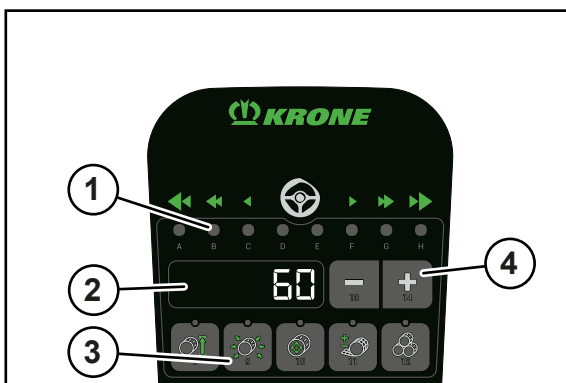

EQG003-116



At the operation unit, the baling pressure in % can be set for the round bale in the working screen.

✓ The setting for the various baling pressures is deactivated, [see Page 116](#).

▶ Press the  key (3) to call the "Baling pressure" menu.

⇒ The indicator lamp above the  key and the LED B (1) emit light.

⇒ The display (2) shows the set target baling pressure in %.

▶ To change the value, press the   keys (4).

➔ The value is saved automatically.

▶ To return to the working screen, press the  key (3) again.

To set a separate baling pressure for the core and the centre of the round bale, [see Page 116](#).

Releasing the baling pressure

The baling pressure can be released for maintenance work at the baling belts or in the bale chamber.

✓ The working screen has been selected, [see Page 111](#).

▶ Press the  key (3) and hold it for approx. 5 seconds.

➔ The baling pressure is released and the indicator lamp above the key flashes.

▶ To build up the baling pressure, once more press the  key (3) and hold it for approx. 5 seconds.

➔ The baling pressure is built up and the indicator lamp above the key goes out.

9.13 Setting the core, centre and edge of the round bale

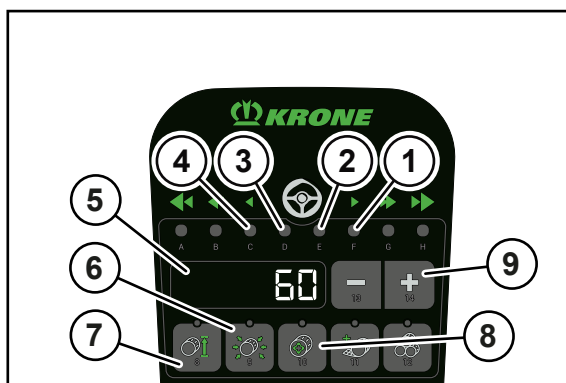

EQ003-247

A different baling pressure can be set for the core, the centre and the edge of the round bale, and a diameter for the core.

The following values are possible:

	Baling pressure	Diameter
Core	0-100 %	Up to 80 cm
Middle	0-100 %	Is calculated automatically from core and edge
Edge	0-100 %	Set bale diameter, see Page 113

As an alternative, the same baling pressure, [see Page 115](#) and a bale diameter can be set for the entire round bale, [see Page 113](#).

Activating the setting for different baling pressures for core, centre and edge of the round bale

▶ Press the  key (8).

➔ The indicator lamp above the  key (8) and the LED C (4) and the LED D (3) emit light.

The following data is shown in the display (5):

Data in the display (3)	Preselected setting
ON	The setting for different baling pressures is activated
OFF	The setting for different baling pressures is deactivated. The baling pressure for the entire round bale is set in the "Baling pressure" menu, see Page 115 .

▶ To activate the setting, press the   keys (9) until the display shows "ON".

➔ The setting is saved automatically.

▶ To deactivate the setting, press the   keys (9) until the display shows "OFF".

➔ The setting is saved automatically.





Setting different baling pressures for the core, centre and edge of the round bale and a diameter for the core of the round bale

The baling pressure for the core, centre and edge of the round bale is set in %.





The diameter for the core is set in a range of 1 to 80 cm.

✓ The setting for different baling pressures is activated.





Setting the diameter of the core

- ▶ Press the  key to go to the diameter setting.
 - ⇒ The indicator lamp above the  key (9) and the LED C (4) emit light and the current diameter of the core is indicated in the display (5).
- ▶ To change the value, press the   keys (9).
 - ⇒ The value is saved automatically.





Setting the baling pressure of the core

- ▶ To set the baling pressure for the core, press the  key again.
 - ⇒ The indicator lamp above the  key (6) and the LED D (3) emit light, and the display (5) indicates the current baling pressure of the core.
- ▶ To change the value, press the   keys (9).
 - ⇒ The value is saved automatically.

Setting the baling pressure of the centre

- ▶ To set the baling pressure for the centre of the round bale, press the  key again.
 - ⇒ The indicator lamp above the  key (6) and the LED E (2) emit light, and the display (5) indicates the current baling pressure of the core.
- ▶ To change the value, press the   keys (9).
 - ⇒ The value is saved automatically.

Setting the baling pressure of the edge

- ▶ To set the baling pressure for the edge of the round bale, press the  key again.
 - ⇒ The indicator lamp above the  key (6) and the LED F (1) emit light, and the display (5) indicates the current baling pressure of the core.
- ▶ To change the value, press the   keys (9).
 - ⇒ The value is saved automatically.



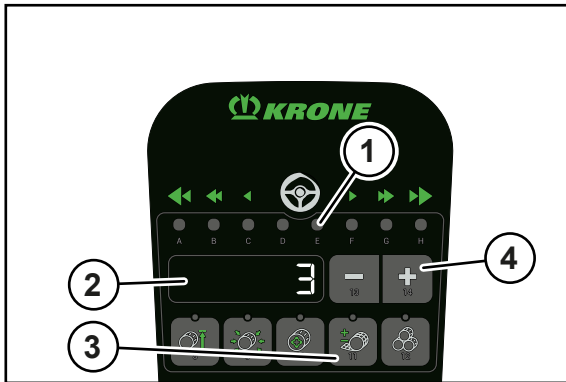

⇒ Press the  key (6) to return to the working screen.

9.14 Setting the number of net layers



EQ003-248

On the operation unit, between 1.5 and 5.0 net layers can be set in the working screen. The display shows the net layers in tenths, for example 35 at 3.5 network layers.

- ▶ To call the "Number of net layers" menu, press the  key (3).
 - ⇒ The indicator lamp above the  key and the LED E (1) emit light.
 - ⇒ The display (2) shows the set number of net layers.
- ▶ To change the value, press the   keys (4).
- ➔ The value is saved automatically.
- ▶ To return to the working screen, press the  key (3) once more.

9.15 Setting the tying start delay

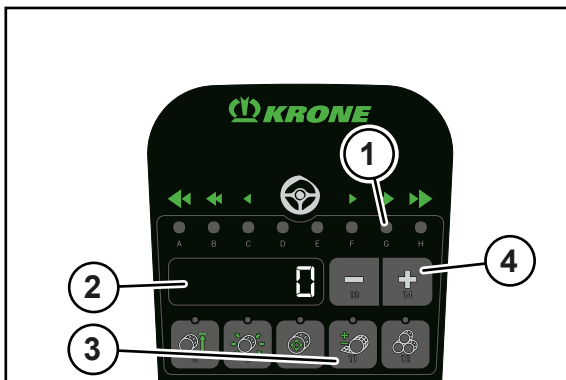

Tying start delay is used to set the period of time which is required between completion of round bale in the bale chamber and triggering the tying cycle. The tying start delay is set in milliseconds.

Setting range: 0-8,000 ms





EQ003-249

On the operation unit, the tying start delay can be set in milliseconds (ms) in the working screen.

- ▶ To call the "Tying start delay" menu, first press the  key (3) and then the  key once.

⇒ The indicator lamp above the  key and the LED G (1) emit light.

⇒ The display (2) shows the set tying start delay in ms.

- ▶ To change the value, press the   keys (4).

➔ The value is saved automatically.

- ▶ To return to the working screen, press the  key (3) once more.

9.16 Displaying the customer counter

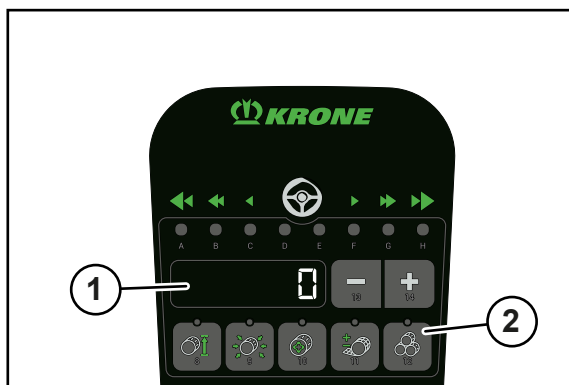

EQ003-250



The customer counter shows the number of the pressed round bales in the display (1). 8 different customer counters can be indicated and saved. Each LED from A-H corresponds to one customer counter. The respective LED emits light when the customer counter has been selected, and flashes when the corresponding customer counter is activated.

After scrolling through to LED H, the display (1) shows the total counter.

- ▶ To call the "Customer counter" menu, press the  key (2).





⇒ The indicator lamp above the  key and the corresponding LED emit light.

⇒ The display (1) shows the number of the pressed round bales.

- ▶ To scroll between the customer counters, press the  key to scroll up and the  key to scroll down.

⇒ One after another, the LEDs emit light, and the corresponding number of pressed round bales is indicated in the display (1). After LED H, all LEDs emit light and the display (1) shows the total counter.

- ▶ To call the total counter directly, press the  key and hold for approx. 1 second.

- ▶ To activate the customer counter which is currently displayed, press the  key.
 - ⇒ The LED of the activated customer counter flashes.
- ▶ To change the number of round bales, press the   key.
- ▶ To set the indicated customer counter to 0, press the  key and hold for approx. 1 second.

9.17 Sensor test for digital and analogue sensors

 **WARNING**

Danger of injury in the danger zone of the machine

If the PTO shaft runs during the sensor test, machine parts may start to move unintentionally. Thus there is a risk of serious injuries or death.

- ▶ Turn off PTO shaft.

In the sensor test, the sensors installed on the machine are checked for faults. Furthermore the sensors can be correctly set in the sensor test. There is no guarantee the machine is working correctly until after the sensors have been adjusted.

Access to the sensor test for digital sensors is possible in road travel screen mode only, [see Page 110](#).

- ▶ To call up the diagnostics section, press the  key and hold it while pressing the  key.

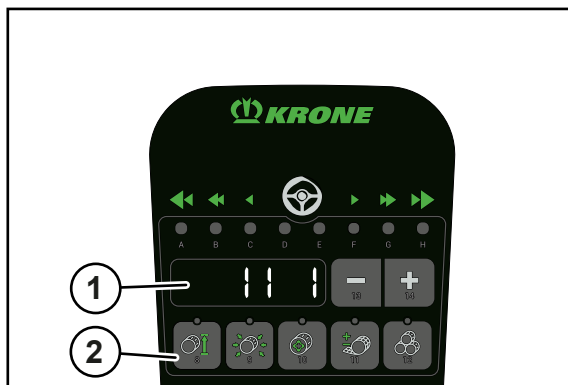

EQ003-530

- ▶ To access the "Sensor test" menu, press the  key (2).
 - ⇒ The indicator lamp above the key emits light.
 - ⇒ **Digital sensors:** The display (1) shows the sensor number on the left and the status of the sensor on the right.
 - ⇒ **Analogue sensors:** The display (1) indicates the sensor number on the left and the current voltage in 1/10 V on the right (e.g. 1.5 = 15 V).



The following status displays for digital sensors are possible:

Status	Display	Sensor status
1	Is lit and a warning sounds	Sensor is attenuated (metal in front of the sensor)
2	Is lit	Sensor is not attenuated
20	Flashes	Short circuit
21	Flashes	Cable break
26	Flashes	General fault

The following sensors can be displayed:

No.	Designation	Sensor type
B01	Speed of bale chamber	digital
B02	Tying process active	digital
B08	Blade cassette up	digital
B09	Filling display left	analogue
B11	Tailgate lock hook left	digital
B12	Tailgate lock hook right	digital
B15	Bale ejection	digital
B61	Tying 1 (passive)	analogue
B67	Blade pre-selection active	digital
B68	Blade pre-selection inactive	digital
B69	Blade active	digital
B82	Direction indicator	analogue
B83	Overload protection baling belts	digital

An overview of the position of the sensors, actuators and control units is provided in the circuit diagram.

- ▶ To switch between the sensors, press the  key to scroll up and the  key to scroll down.
- ▶ To eliminate an error on the sensor, [see Page 251](#).
- ▶ To quit the diagnostics section, press the  key and hold for approx. 1 second.

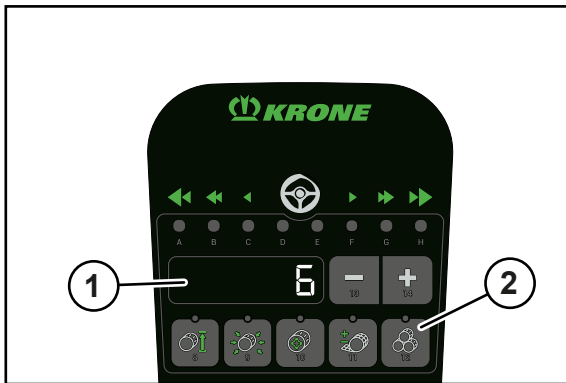

9.18 Calibrating sensors



EQ003-529



✓ The "Sensor test" menu has been selected, [see Page 121](#).

▶ To access the "Calibrate sensors" menu, press the  key.





- ⇒ The indicator lamp above the  key flashes and the indicator lamp above the  key is lit.
- ⇒ The display shows the currently measured voltage of the selected sensor is indicated in 1/10 V.
- ⇒ One of the LEDs A-E is lit.

The LEDs A–E stand for the following sensors:

LED	Sensor		Additional
A	B09	Filling display left	
B	B10	Filling display right	
C	B61	Tying 1 (passive)	Set feed position of the feed rocker arm
D	B61	Tying 1 (passive)	Set end position of the feed rocker arm
E	B82	Direction indicator	

▶ To switch between the sensor calibrations, press the  key to scroll up and the  key to scroll down.

Calibrating sensor B61 "Tying 1 (passive)"



- ▶ Call sensor B61.
- ▶ To change the value, press the   keys.
 - ⇒ As soon as the sensor value is within a valid range, the indicator lamp under the  key is lit.
- ▶ To save the value, press and hold down the  key.
- ➔ The sensor has been calibrated and a confirmation tone sounds.

Calibrating the remaining sensors



The remaining sensors must be mechanically set on the machine if they display an error in the sensor test.

An overview of the position of the sensors, actuators and control units is provided in the circuit diagram.

Set feed position of the feed rocker arm

- ✓ The LED C is lit.
- ▶ To move the feed rocker arm in the direction of the feed position, press the   keys.
 - ▶ To save the value, press and hold down the  key.
 - ➔ The sensor has been calibrated and a confirmation tone sounds.

Set end position of the feed rocker arm

- ✓ The LED D is lit.
- ▶ To move the feed rocker arm in the direction of the end position, press the   keys.
 - ▶ To save the value, press and hold down the  key.
 - ➔ The sensor has been calibrated and a confirmation tone sounds.

9.19 Actuator test for digital and analogue actuators

WARNING



Risk of injury due to non-observance of the safety routines

If the relevant safety routines are not observed, persons may be seriously injured or killed.

- ▶ The safety routines must be read and observed to avoid accidents, [see Page 28](#).

The actuator test is used to test the actuators installed on the machine. An actuator can only be tested when current is flowing through it. Therefore, in the "Actuator test" menu, the actuator must be controlled manually for a short time in order to determine possible errors in the actuator system.

The actuator test can be called up from the road traffic screen only, [see Page 110](#).

- ▶ To call up the diagnostics section, press the  key and hold it while pressing the  key.

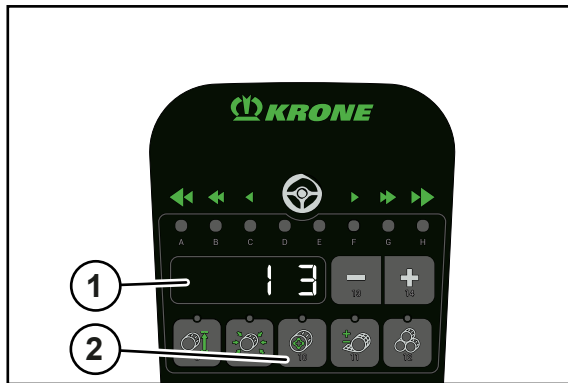

EQ003-531

- ▶ To access the "Actuator test" menu, press the  key (2).
 - ⇒ The indicator lamp above the key emits light.
 - ⇒ The display (1) shows the actuator number on the left and the status of the actuator on the right.

The following status displays for actuators are possible:

Status	Display	Actuator status
3	Is lit	Actuator ON
4	Is lit	Actuator OFF
20	Flashes	Short circuit
21	Flashes	Cable break
26	Flashes	General fault



The following actuators can be displayed:

No.	Designation
E20	Working lights net roll (for the "Working lights" version)
E22/E23	Maintenance lighting side hood left/right
K01	Pick-up
K03	Raising/lowering blade cassette
K21	Blade control shaft A active
Q26	Lowering the feed rocker arm
Q27	Lifting the feed rocker arm
Q41	Baling pressure
M01	Motor tying 1 (passive)

An overview of the position of the sensors, actuators and control units is provided in the circuit diagram.



- ▶ To switch between the actuators, press the  key to scroll up and the  key to scroll down.

Switching actuators on/off

- ▶ Press the  key to switch the indicated actuator on.
- ▶ Press the  key to switch the indicated actuator off.

Increase/decrease the currents of the analogue actuators

With the analogue actuators Q30 and Q41, the mA values of the current can be increased or decreased .

- ▶ Select the required actuator.
 - ⇒ The currently set current is indicated in the display in mA.
- ▶ Press the  key to increase the current of the indicated actuator.
- ▶ Press the  key to reduce the current of the indicated actuator.

9.20 Error messages

The error messages can be indicated in the working screen or road travel screen.



If an error message is pending, the LEDs A-H flash.

The display shows the error number of the error message.

- ▶ To indicate the FMI of the error message, press the  key.

For an explanation of the configuration of an error message, [see Page 249](#).

Acknowledging error message

- ▶ Note down the error number.
- ▶ Press the  or  key.
- ➔ The acoustic signal stops and the error message is no longer indicated.
- ▶ Eliminate the fault. See Chapter "Error list" in the supplement to the operating instructions "Error messages".

If the fault occurs again, the error message will be displayed again.

9.21 Manual operation of the tying system

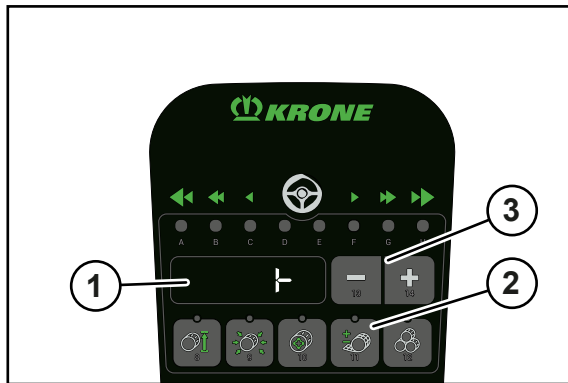

EQ003-528

When the tying system is manually operated, the feed rocker arm can be manually moved. For an overview of the positions of the feed rocker arm, [see Page 252](#).

- ▶ To access the "Manual operation" menu, press the key (2) and hold down for approx.4 seconds.
 - ⇒ The indicator lamp above the key flashes.
 - ⇒ The display shows the current position of the feed rocker arm.

The following displays are possible:

Display	Explanation
	The feed rocker arm is in the limit position.
	The feed rocker arm is in the feed position.
	The feed rocker arm is between the limit and feed position. This display is also shown while the feed rocker arm is moving.

- ▶ To move the feed rocker arm to the limit position, press the key and hold down until is displayed.
- ▶ To move the feed rocker arm to the feed position, press the key and hold down until is displayed.
- ▶ To move the feed rocker arm to the tying position, press the key and hold down.
- ▶ To return to the working screen, press the key and hold down.

9.22 Setting user preferences

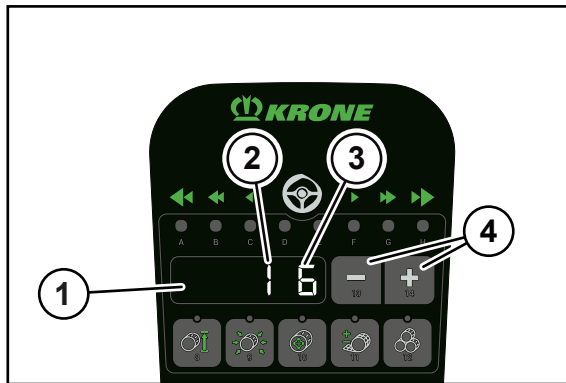

EQG003-123



The following is set in the user settings:



- volume,
 - background lighting for day or night design,
 - display lighting for day or night design
- . Additionally, day or night design can be activated.
- ✓ The road travel screen is open, [see Page 110](#).

▶ To call the "User settings" menu, press the  key and the  key (4) simultaneously.

➔ The display (1) shows the number of the setting (2) and the set value (3).

Number of the setting (2)	Setting type	Value range (3)
1	Volume	0-10
2	Background lighting day design	0-10
3	Background lighting night design	0-10
4	Display lighting day design	1-10
5	Display lighting night design	1-10
6	Day or night design	d for day n for night

▶ To change between the settings, press the  or  key.

▶ To change the value, press the   keys (4).

➔ The value is saved automatically.

10 KRONE Terminal DS 500

NOTICE

Penetration of water in the terminal could lead to malfunction. As a result, the machine can no longer be operated safely.

- ▶ Protect the terminal from water.
- ▶ If the machine is not used for an extended period of time (for example in winter), the terminal must be stored in a dry place.
- ▶ For mounting and repair jobs, especially for welding jobs on the machine, disconnect the power supply to the terminal.

10.1 Touchable display

To provide menu guidance and entry of values/data, the terminal is equipped with a touch-capable display. By touching the display, you can call up and change values in blue font.

10.2 Switching terminal on/off



EQ003-253

- ▶ Before switching on the terminal for the first time, check that the connections are correct and tight.

INFO

When the terminal is switched on for the first time, the machine configuration is loaded into the terminal and saved in the terminal memory. Loading may take a few minutes.

Switching ON

- ▶ Press and hold down the key (1).
 - ⇒ If the machine is not connected, the display shows the main menu after switching on.
 - ⇒ If the machine is connected, the display shows the road travel screen after switching on.
- ➔ The terminal is ready to operate.

Switching off

- ▶ Press and hold down the key (1).

10.3 Design DS 500

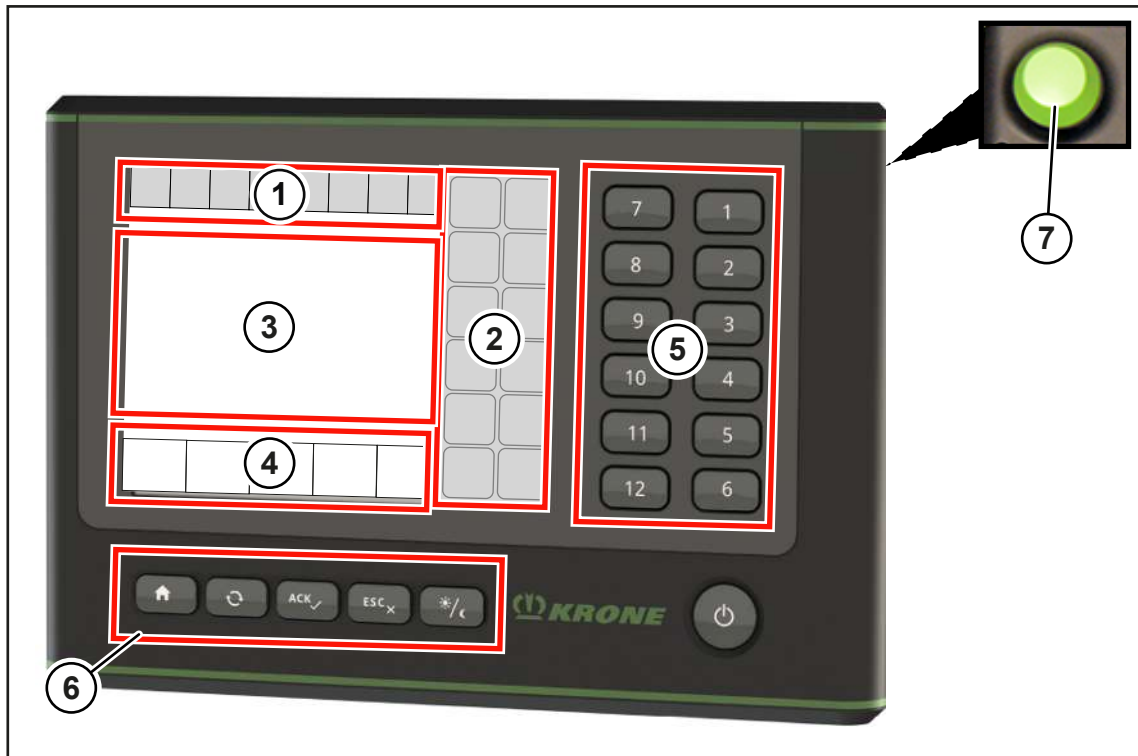

EQ003-254

The KRONE machine application is divided into the following areas:

Status line (1)

The status line (1) indicates current states of the machine (depending on how it is equipped), [see Page 137](#).

Keys (2)

The machine is operated by pressing the keys (2) via touch function, [see Page 138](#).

Main window (3)

Values (figures) shown in blue in the main window can be selected using the touch function.

There are the following main window views:

- Road travel screen, [see Page 110](#)
- Working screen, [see Page 140](#)
- Menu level, [see Page 157](#)

Information bar (4)





The information bar shows information on the working screen, [see Page 142](#).

Keys (5)

Alternatively, the machine is operated by pressing the keys (5) without the touch function.

Keys (6)

The keys (6) can be used to open the main menu or the working screen and to confirm the error messages and set the brightness.

Icon	Designation	Explanation
	Main menu	Open the main menu of the terminal.
	Swap key	Switch between the main menu and the working screen of the terminal. With more than one machine mask, the views switches to the next one.
	ACK (acknowledgement key)	Confirm error messages.
	ESC (back key)	Leave the menu without saving.
	Brightness	Switch from day to night design and vice versa.

Scroll wheel (7)

Alternatively, the values (figures) shown in the main window (3) can be selected and set using the scroll wheel (7). The scroll wheel (7) can also be used to navigate between the individual menus.

Turning the scroll wheel to the right:

- Increase the value.
- Navigate to the next value in the menu.
- Navigate to the next menu.

Turning the scroll wheel to the left:

- Reduce the value.
- Navigate to the previous value in the menu.
- Navigate to the previous menu.

Press the scroll wheel:

- Select the value.
- Save the value.
- Open the menu.

11 KRONE ISOBUS terminal (CCI 800, CCI 1200)

NOTICE

Penetration of water in the terminal could lead to malfunction. As a result, the machine can no longer be operated safely.

- ▶ Protect the terminal from water.
- ▶ If the machine is not used for an extended period of time (for example in winter), the terminal must be stored in a dry place.
- ▶ For mounting and repair jobs, especially for welding jobs on the machine, disconnect the power supply to the terminal.

The ISOBUS system is an internationally standardised communications system for agricultural machines and systems. The designation of the associated series of standards is: ISO 11783. The agricultural ISOBUS system enables information and data to be exchanged between tractor and unit of different manufacturers. For this purpose, both the required plug connections and the signals are standardised which are required for the communication and transmission of commands. The system also enables machines to be operated with operation units (terminals) which are already available on the tractor or have been attached e.g. to the tractor cabin. The relevant information can be found in the technical documents of the operation device or on the units themselves.

KRONE machines, which have ISOBUS equipment, are coordinated with this system.

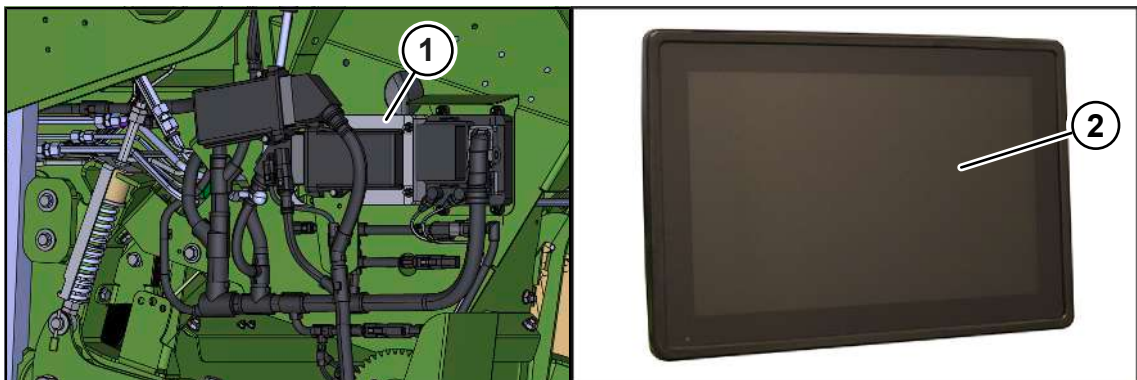

EQG000-057

The electronic equipment of the machine consists essentially of the job computer (1), the terminal (2) and the control and function elements.

The job computer (1) is located on the right-hand side of the machine under the side hood.

Functions of the job computer (1):

- Control of actuator system installed on the machine.
- Transmission of error messages.
- Evaluation of sensor system.
- Diagnostics of sensor system and actuator system.

11.1 Touchable display

To provide menu guidance and entry of values/data, the terminal is equipped with a touch-capable display. By touching the display, you can call up and change values in blue font.

11.2 Switching terminal on/off



EQ001-174

KRONE ISOBUS terminal CCI 1200	KRONE ISOBUS terminal CCI 800
--------------------------------	-------------------------------

- ▶ Before switching on the terminal for the first time, check that the connections are correct and tight.

INFO

When the terminal is switched on for the first time, the machine configuration is loaded into the terminal and saved in the terminal memory. Loading may take a few minutes.

Switching ON

- ▶ Press and hold down the key (1).
 - ⇒ If the machine is not connected, the display shows the main menu after switching on.
 - ⇒ If the machine is connected, the display shows the road travel screen after switching on.
- ➔ The terminal is ready to operate.

If machine is not connected: "Main menu"

If machine is connected: "Road travel screen"

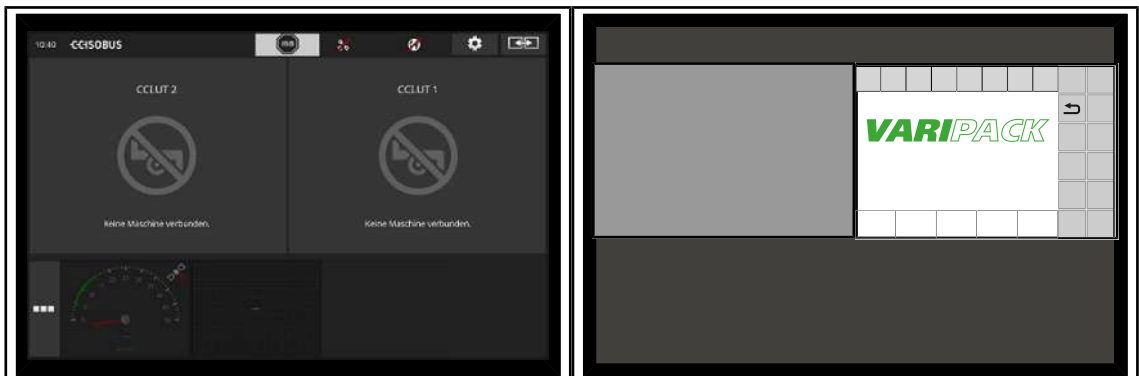

EQG000-056

The display appears in landscape mode after starting the terminal. Refer to the CCI terminal operating instructions if you want the display in portrait rather than landscape mode or if you wish to expand the terminal applications to full view.

Switching off

- ▶ Press and hold down the key (1).

INFO

► For more details on how the terminal functions, follow the terminal operating instructions.

11.3 Design of display

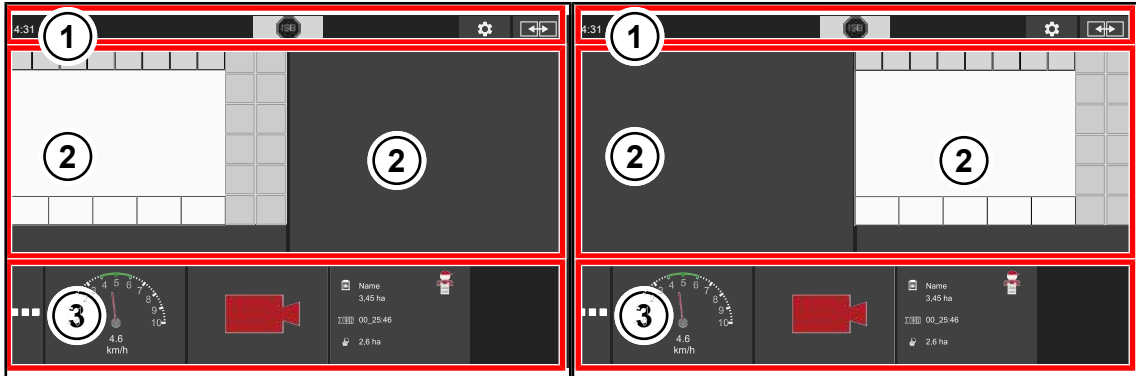

EQG000-058

Pos.	Designation	Explanation
1	Status line	
2	Main view left/right	When operating the machine, KRONE recommends positioning the machine application in the main view.
3	Information view	Additional applications (apps) can be selected from the App menu and displayed in the Information view. The apps can be dragged and dropped into the Main view.

INFO

► For more details on how the terminal functions, follow the terminal operating instructions.

11.4 Design of the KRONE machine application

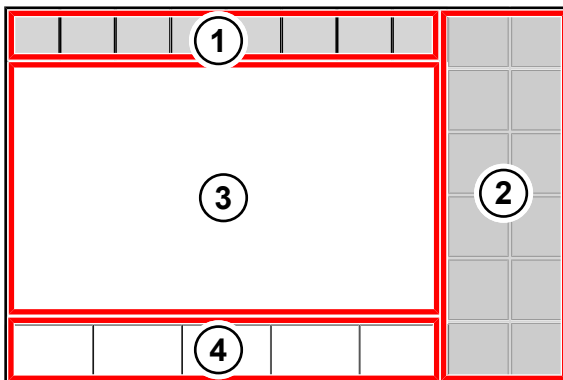

EQG000-059

The KRONE machine application is divided into the following areas:

Status line (1)

The status line (1) indicates current states of the machine (depending on how it is equipped), see [Page 137](#).

Keys (2)

The machine is operated by pressing the keys (2) via touch function, [see Page 138](#).

Main window (3)

Values (figures) shown in blue in the main window can be selected using the touch function.

There are the following main window views:

- Road travel screen, [see Page 110](#)
- Working screen, [see Page 140](#)
- Menu level, [see Page 157](#)

Information bar (4)

The information bar shows information on the working screen, [see Page 142](#).

11.5 Setting units on the terminal

The units, e.g. metric or imperial, can be set on the terminal in the menu "User settings". This setting is accepted after the terminal has been restarted as well as for the machine software.

The procedure and other settings can be found in the operating instructions for the terminal.

12 Foreign ISOBUS terminal

WARNING

Risk of injury caused by utilization of foreign terminal or other operation units

When using terminals and other operation units which have not been delivered by KRONE mind that the user:

- ✓ assumes the responsibility for the use of KRONE machines when using the machine on operation units (terminal / other operating elements) which have not been delivered by KRONE.
- ✓ only connects such systems (if possible) which have passed a AEF/DLG/VDMA test (so-called ISOBUS COMPATIBILITY TEST).
- ✓ has to follow the operating and safety instructions of the supplier of ISOBUS operation unit (e.g. terminal).
- ✓ must ensure that the used operating elements and machine controls concerning IL (IL = Implementation Level; describes compatibility levels of different software versions) must fit together (condition: IL same or higher).
- ▶ Before using the machine, make sure that all machine functions are performed according to the enclosed operating instructions.

INFO

KRONE ISOBUS systems regularly pass the ISOBUS COMPATIBILITY TEST (AEF/DLG/VDMA test). The operation of this machine at least requires implementation level 3 of ISOBUS system.

The ISOBUS system is an internationally standardised communications system for agricultural machines and systems. The designation of the associated series of standards is: ISO 11783. The agricultural ISOBUS system enables information and data to be exchanged between tractor and unit of different manufacturers. For this purpose, both the required plug connections and the signals are standardised which are required for the communication and transmission of commands. The system also enables machines to be operated with operation units (terminals) which are already available on the tractor or have been attached e.g. to the tractor cabin. The relevant information can be found in the technical documents of the operation device or on the units themselves.

KRONE machines, which have ISOBUS equipment, are coordinated with this system.

12.1 Varying functions to KRONE ISOBUS terminal

The job computer provides information and control functions of the machine on the display of the external ISOBUS terminal. Operation with an external ISOBUS terminal is similar to operation with the KRONE ISOBUS terminal. Before commissioning, refer to the mode of operation of the KRONE ISOBUS terminal in the operating instructions.

A major difference to the KRONE ISOBUS terminal is the arrangement and number of keys with functions determined by the selected external ISOBUS terminal.

13 Terminal machine functions

WARNING

Personal injuries and/or machine damage caused by non-compliance of error messages

If error messages are ignored and the malfunction is not remedied, people may be injured and/or the machine may be damaged seriously.

- ▶ Remedy the malfunction when the error message is displayed, [see Page 249](#).
- ▶ If the malfunction cannot be remedied, consult a KRONE service partner.

13.1 Status line

INFO

Using a terminal with a resolution of less than 480x480 pixels.

On terminals with a resolution of less than 480x480 pixels, only 7 fields are displayed in the status line. Thus, not all icons for the status line are shown.

On terminal with a resolution of more than/equal to 480x480 pixels, 8 fields are shown in the status line.







EQ000-901

Icons displayed with shading () can be selected. If an icon with shading is selected:

- a window with further information opens or
- a function is activated or deactivated.

The status line shows the current states of the machine (depending on how it is equipped):

Icon	Explanation
	There are one or more error messages. For version with "Touch-capable display": If this icon is pressed, the pending error messages open in sequence, see Page 249 .
	Blades swivelled in (activated).
	Blades swivelled out (deactivated).
	Blade and blade cassette in maintenance position: The blade cassette has been lowered and blade pre-selection has been deactivated.









Icon	Explanation
	Blades in undefined state.
	Pre-signalling set.
For version with "TIM 1.0"	
	TIM status: The machine is being registered and authenticated with the tractor.
	TIM status: The machine has been registered and authenticated. By pressing the key , the TIM status switches to .
	TIM status: The machine waits for confirmation of the tractor. Confirmation on the terminal or on another control panel on the tractor causes the TIM status to switch to .
	TIM status: The machine and the tractor are successfully connected. The machine automatically takes over control of the TIM functions on the tractor, see Page 148 .
	Flashing: 2 TIM functions are currently active, one TIM function of which has been overridden. The connection is restored by pressing the key and then confirming on the tractor.
For "Working lights" version	
	Switched on.
	Switched off.

13.2 Keys

The keys that are available depend on the machine configuration. The keys listed below are not always available.





Dimmed keys are currently not available.

Icon	Designation	Explanation
	Feeding wrapping and tying material in manual mode.	Press the key to feed wrapping material to the round bale.
	Switching tying to automatic operation.	The previously selected mode of operation, "Manual operation" or "Automatic operation", is shown on the key. Press the key to change the mode of operation.
	Switching tying to manual operation.	
	Preselect blades.	When the key has been pressed, the control unit must be actuated to swivel the blades in or out.

Icon	Designation	Explanation
	Pre-select pick-up.	The setting previously selected, pick-up or blade adjustment is displayed. Press the key to change the setting.
	Pre-select blade adjustment.	
	Switching working lights off.	The previously selected setting "Working lights switched off" or "Working lights switched on" is displayed on the key. Press the key to change the setting.
	Switch the working lights on.	
	Switch the warning beacon off.	(Warning beacon only for certain countries) The previously selected setting "Warning beacon switched off" or "Warning beacon switched on" is displayed on the key. Press the key to change the setting.
	Switch the warning beacon on.	
	Menu level on the terminal.	Press the key to open the menu level on the terminal, see Page 157 .
	Open the Counters menu.	Press the key to open Menu 13 "Counters", see Page 175 .
	Scrolling display pages.	

For version with "TIM 1.0"

The keys can be used to operate the following functions. If the key is greyed out, the function is not available.

Icon	Explanation
 	Start TIM functions (can be selected only when tailgate closed).
 	Pause TIM functions. In doing so, registration and authentication are not disconnected between tractor and machine.

13.3 Displays on the working screen

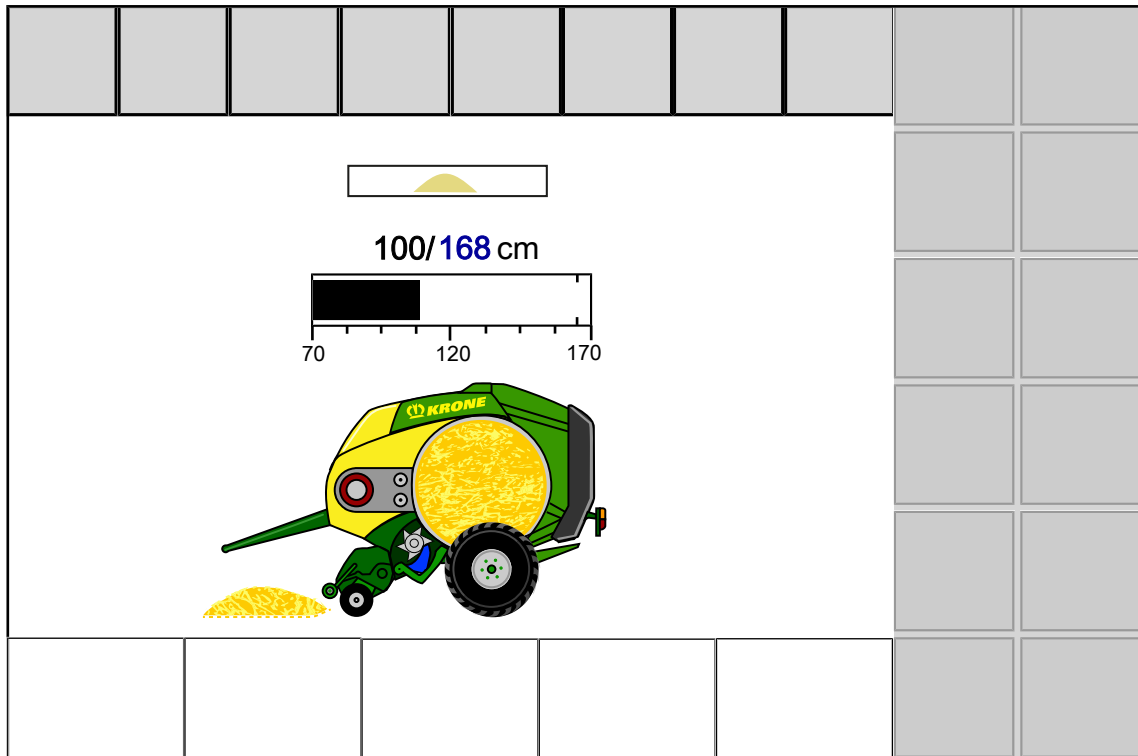

EQG003-009

The available icons comply with the equipment of the machine. The following represented icons are not always available.

Icon	Explanation
	For version with "TIM 1.0": A TIM function is active on the machine.
	Direction display.
	Direction display arrows: Arrows appear during operation on the left and right sides of the direction display. The arrows have three different sizes, numbered from 1 to 3. The arrows show the driver to which side and to what extent he must correct his direction when driving over the swath in order to ensure the bale chamber is filled evenly. If the direction of travel is not corrected, the arrow displayed starts flashing and an acoustic signal sounds. Detailed information on the direction display, see Page 143
	Set and display bale diameter. The bale diameter can be set directly on the working screen, see Page 147 .
	For version with "TIM 1.0": TIM function "Opening and closing tailgate at the end of the tying cycle" has been activated. The TIM function can be switched off individually via the checkbox, e.g. if the machine is in an unfavourable position for ejecting the round bale. To configure the TIM software, see Page 180

Round baler

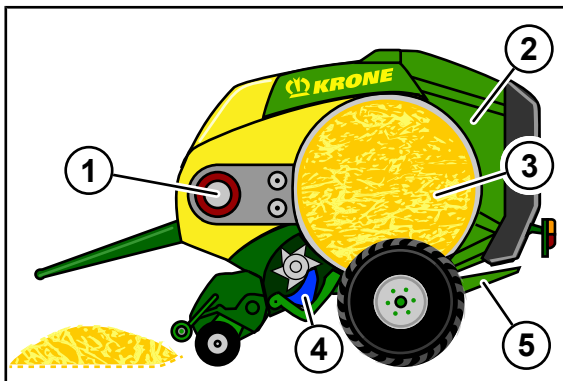



EQG003-122

The round baler in the centre of the working screen shows

- the progress of the baling process by means of the expanding round bale (3),
- the progress of the tying process by means of the net roll (1) and by means of the red net running around the round bale,
- the positions of the blade cassette (4)
- and the bale ejection by means of the opening tailgate (2) and the position of the bale ejector (5).

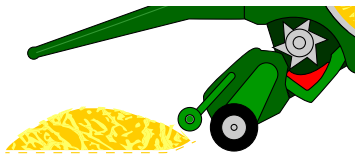
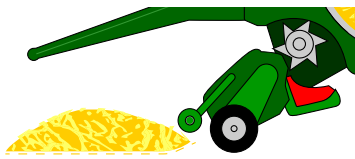
The blade cassette (4) can show the following positions:

Icon	Explanation
	The blades have been swivelled in and the blade cassette is in the upper position.
	The blades have been swivelled out and the blade cassette is in the upper position.
	The blade cassette is in the lower position. This maintenance position is used, for example, to change the blades, see Page 229 , or to remove crop blockages, see Page 105 .
	The blade cassette is in the lower position.

Icons during net wrapping or twine tying

Icon		Explanation
1		Value of bale diameter/baling pressure has been reached (flashing).
2N	2G	Net/twine is fed.
3N	3G	Net/twine is not pulled.
4N	4G	Net wrapping/twine tying is active.
5N	5G	Net wrapping/twine tying is stopped.
6N	6G	Net/twine is cut off.
7N	7G	Net wrapping/twine tying has not been cut off.
8N	8G	Net wrapping/twine tying is complete.
9N	9G	Net/twine is pulled without a tying cycle having been actuated.

In addition, the progress of the net wrapping or twine tying is displayed as a percentage under the icon.

13.4 Displays on the information bar

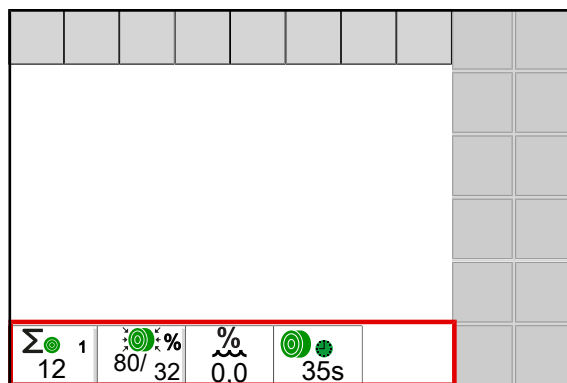

EQG003-111

The available icons comply with the equipment of the machine. The following represented icons are not always available.

Icon	Designation	Explanation
	Customer counter	The selected customer counter is displayed and shows the current total of pressed round bales. If the display is pressed, Menu 13-1 "Customer counter" opens, see Page 175 .
	Baling pressure	The selected target baling pressure in % is shown on the left. The actual baling pressure in % is shown at the bottom right. If the display is pressed, Menu 6 "Electronic baling pressure setting" opens so that the baling pressure can be set, see Page 163 .
	Moisture measurement	The current degree of moisture of the crops is displayed. For settings in the moisture measurement, see Menu 12-1 "Error message for moisture measurement", see Page 172 . or Menu 12-2 "Correction value for moisture measurement", see Page 173 .
	Bale cycle time	The time is displayed how long the last round bale was pressed.

13.5 Direction display

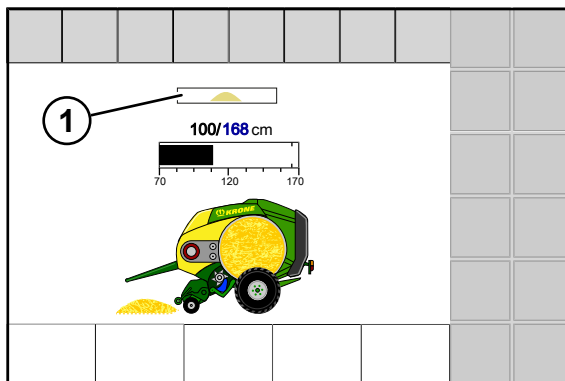

EQG003-105

The direction display (1) shows the driver to which side and to what extent he must correct his direction when driving over the swath in order to ensure the bale chamber is filled evenly.

The following displays are possible:

Icon	Explanation
	Swath is picked up in the middle
	Step 1: The bale chamber is filled slightly too much on the left side. Steer the tractor to the left to pick up the swath on the right of the bale chamber.
	Step 2: The bale chamber is filled too much on the left side. Steer the tractor to the left to pick up the swath on the right of the bale chamber.
	Step 3: The bale chamber is filled very heavily on the left side. Steer the tractor to the left to pick up the swath on the right of the bale chamber.
 Arrow flashes	Step 4: The bale chamber is only filled on the left side. Steer the tractor to the left to pick up the swath on the right of the bale chamber.
	Step 1: The bale chamber is filled slightly too much on the right side. Steer the tractor to the right to pick up the swath on the left of the bale chamber.
	Step 2: The bale chamber is filled too much on the right side. Steer the tractor to the right to pick up the swath on the left of the bale chamber.
	Step 3: The bale chamber is filled very heavily on the right side. Steer the tractor to the right to pick up the swath on the left of the bale chamber.
 Arrow flashes	Step 4: The bale chamber is only filled on the right side. Steer the tractor to the right to pick up the swath on the left of the bale chamber.

For more information on how the bale chamber is filled, [see Page 77](#).

- ▶ If the swath is the same width as the bale chamber, pick up the swath as centrally as possible

- ▶ If the swath is too narrow, pick it up alternately (on left/right). Ensure that you do not move too far to the left or right

13.6 ISOBUS Shortcut Button (ISB)

 **WARNING**

The ISOBUS Shortcut Button is not an EMERGENCY STOP device. If the ISOBUS Shortcut Button is mistaken for an EMERGENCY STOP device, there is danger to life.

When actuating the ISOBUS Shortcut Button, activated machine functions are deactivated. Process-oriented sequences run through to the end. Therefore machine parts may continue to run after actuation of the ISOBUS Shortcut Button. This may lead to injuries.

The ISOBUS Shortcut Button does in no case intervene in the tractor functions, i.e. neither the universal shaft function nor the hydraulic function is affected. Therefore the machine can continue to run after ISOBUS Shortcut Button is actuated. This may lead to injuries.

- ▶ Never use the ISOBUS Shortcut Button as an EMERGENCY STOP device.
- ▶ Before working on the machine, shut down and safeguard the machine, [see Page 28](#).

The ISOBUS Shortcut Button allows the functions of a machine that was activated via an ISOBUS terminal to be deactivated. To be able to use the function of the ISOBUS Shortcut Button, at least one ISOBUS Shortcut Button must be available. The ISOBUS Shortcut Button can be integrated both in/on the terminal or can be available as an external momentary switch in the ISOBUS system. The KRONE Machine Controller (KMC) reads out the information whether an ISOBUS Shortcut Button is available in the ISOBUS system.

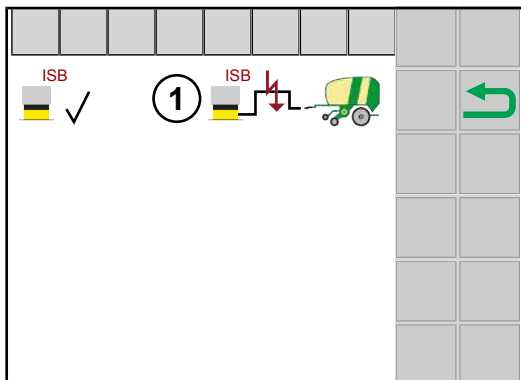

EQG000-022

If the KRONE Machine Controller (KMC) detects an ISOBUS Shortcut Button, the icon  is displayed when the terminal starts.

If the KRONE Machine Controller (KMC) detects no ISOBUS Shortcut Button, the icon  is displayed when the terminal starts.

Actuating ISOBUS Shortcut Button

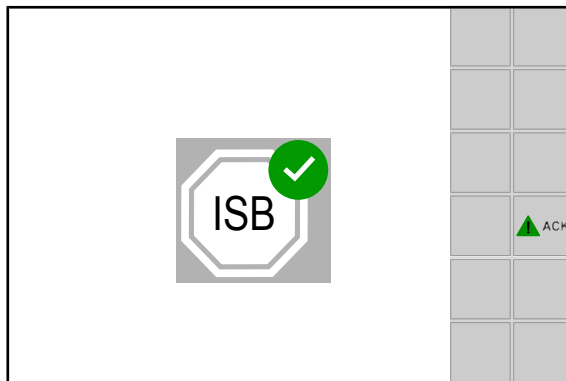

EQG001-009

- ▶ Actuate the ISOBUS Shortcut Button.
- ➔ The message above appears on the display.

The job computer blocks the following functions on machine side:

- all hydraulic functions on the machine side

Releasing the machine functions

- ▶ Press .

- ➔ The message above goes out on the display and all machine functions are available again.

13.7 Accessing the working screen

Road travel screen

Example menu

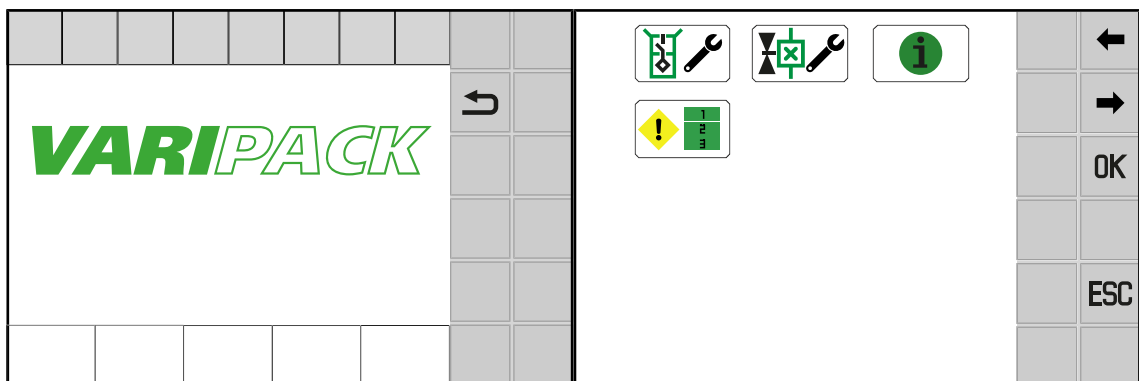

EQG003-045

From the road travel screen

- ▶ Press .

- ➔ The working screen is shown, [see Page 140](#).

In each menu

- ✓ A menu is displayed.
- ▶ Press and hold **ESC** for a moment.

13.8 Automatic call of the Road travel screen

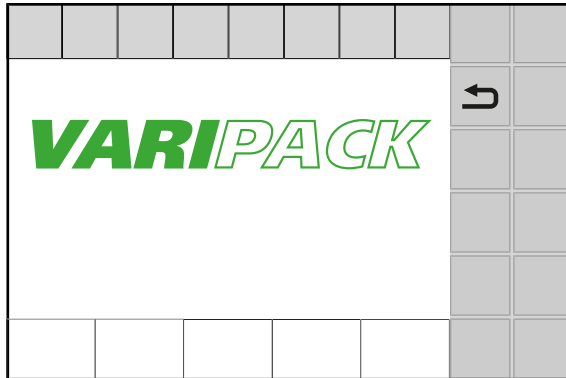

EQG000-026

The terminal switches automatically to the Road travel screen after roughly five minutes when the following requirements are met:

- ✓ The PTO shaft is switched off.
- ✓ The tailgate is closed.
- ✓ The machine is in field mode.

13.9 Adjusting bale diameter

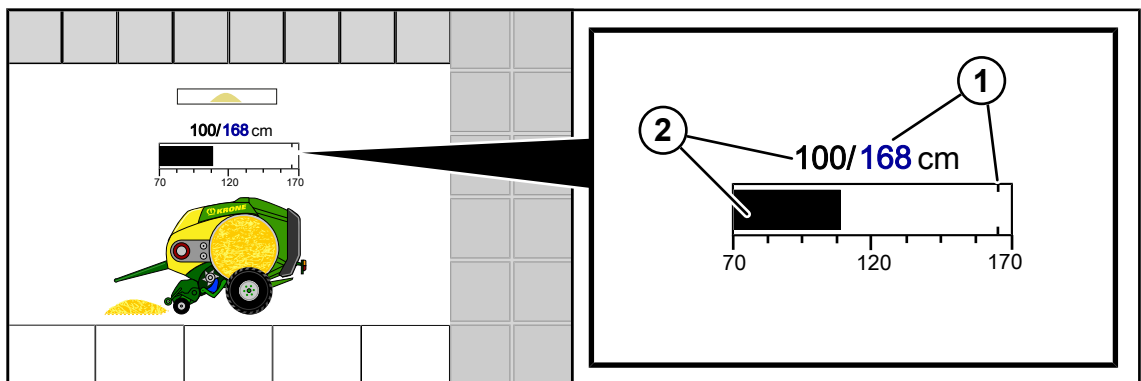

EQG003-037

1 Set setpoint bale diameter in cm

2 Actual bale diameter in cm

Adjusting the bale diameter via the scroll wheel

- ▶ Select the blue value to be changed using the scroll wheel.
 - ⇒ The icon is shown in reverse colours.
- ▶ Press the scroll wheel.
 - ⇒ An input field opens.
- ▶ To increase or reduce the value, turn the scroll wheel.
- ▶ To save the value, press the scroll wheel.
 - ⇒ The setting is accepted, the input field closes.

Adjusting the bale diameter via the touch-capable display

- ▶ Touch the blue value you want to change.
 - ⇒ An input field opens.
- ▶ Enter the desired value and press **OK**.
 - ⇒ The value is saved and the input field is closed.

13.10 Operating TIM 1.0 (Tractor Implement Management)

13.10.1 Mode of operation of TIM 1.0

 **WARNING**

Risk of injury due to unpredictable movement of the round bales when the machine is operating on a slope

If round bales are deposited on a slope, they may start moving on their own. Once round bales have started moving, their weight and cylindrical shape may cause serious accidents and injure people.

- ▶ On slopes, deposit round bales in manual mode only.
- ▶ On slopes, always deposit round bales in such a way that they cannot start moving on their own.

TIM 1.0 (Tractor Implement Management) uses data exchange between the ISOBUS job computers on machine and tractor so that the machine can control the tractor and therefore take pressure off the driver.

When the tying cycle starts, the tractor is automatically stopped by TIM. When the tying cycle is complete, the tailgate is automatically opened by TIM, the round bale is ejected and the tailgate is closed. To bale the next round bale, the driver only has to approach the tractor. Then the tractor driver must independently drive at a speed adjusted to visibility, weather or ground conditions.

13.10.2 TIM displays and keys on the working screen

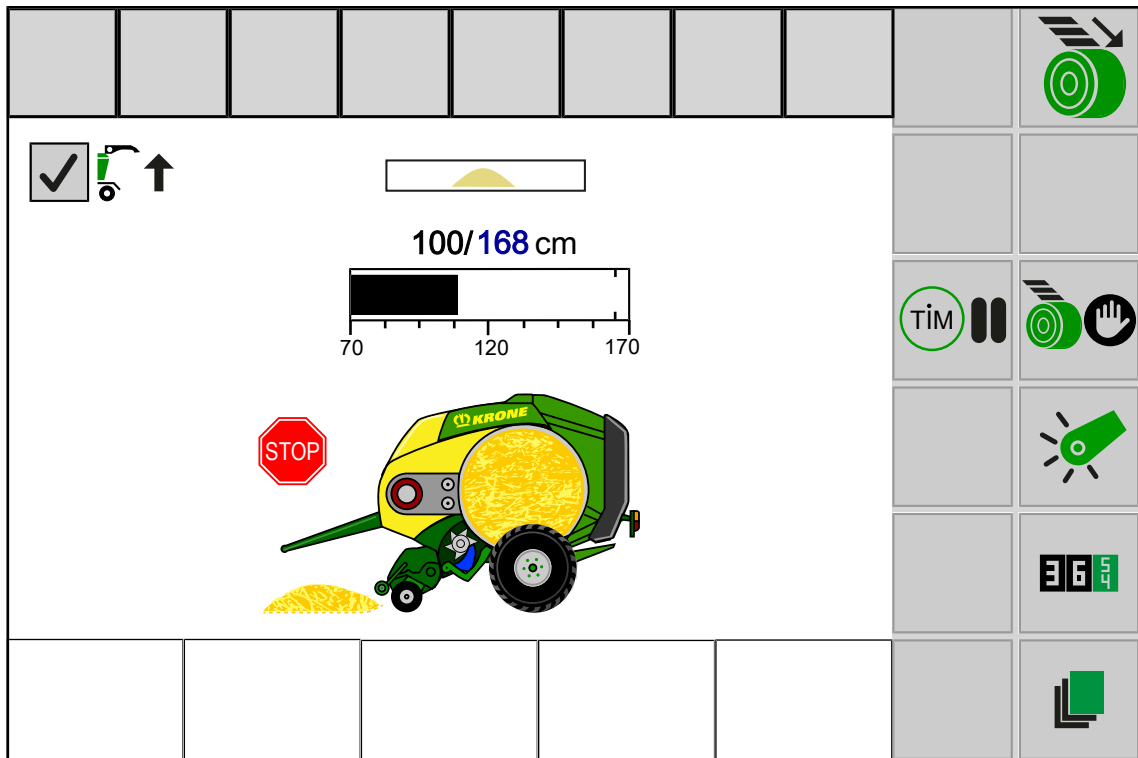

EQG003-096

The following TIM displays are possible:

Icon	Explanation
	For version with "TIM 1.0": TIM function "Opening and closing tailgate at the end of the tying cycle" has been activated. The TIM function can be switched off individually via the checkbox, e.g. if the machine is in an unfavourable position for ejecting the round bale. To configure the TIM software, see Page 180
	For version with "TIM 1.0": A TIM function is active on the machine.

The following status displays could appear in the status line:

Icon	Explanation
For version with "TIM 1.0"	
	TIM status: The machine is being registered and authenticated with the tractor.
	TIM status: The machine has been registered and authenticated. By pressing the key, the TIM status switches to

Icon	Explanation
	TIM status: The machine waits for confirmation of the tractor. Confirmation on the terminal or on another control panel on the tractor causes the TIM status to switch to
	TIM status: The machine and the tractor are successfully connected. The machine automatically takes over control of the TIM functions on the tractor, see Page 148 .
	Flashing: 2 TIM functions are currently active, one TIM function of which has been overridden. The connection is restored by pressing the key and then confirming on the tractor.

The keys can be used to operate the following functions. If the key is greyed out, the function is not available.

Icon	Explanation
	Start TIM functions (can be selected only when tailgate closed).
	Pause TIM functions. In doing so, registration and authentication are not disconnected between tractor and machine.

13.10.3 Activating TIM functions

If the machine was switched off and is switched on again, registration and authentication between tractor and machine are automatically restored. The same control unit is used for the TIM function "Opening and closing tailgate at the end of the tying cycle" which was used the last time the machine was commissioned.

To activate the TIM functions, only the connection between machine and tractor must be established.

- ✓ In menu 14-5 "Configuring TIM software" ([see Page 180](#))
 - the required TIM functions were selected and
 - registration and authentication were run on the tractor.

- ✓ The TIM status on the working screen is on

▶ Press .

▶ Confirm the TIM functions on the terminal or on another control panel on the tractor.

➔ The TIM status switches to . The machine automatically takes over control of the TIM functions on the tractor.

If no TIM status is displayed on the working screen, the TIM functions must be selected and registered and authenticated via menu 14-5 "Configuring TIM software", [see Page 180](#).

INFO

In the case of the TIM function "Stop tractor when the tying cycle starts", the tractor must be driven at a speed of at least 0.5 km/h before the TIM function can be confirmed on the tractor.

INFO

If 2 TIM functions are active and one of them is overridden, the TIM status  flashes.

If only one TIM function is active and is overridden, the TIM status switches to 

▶ To restore the connection, press the key .

13.10.4 Pausing TIM functions

If TIM is not to be used for the time being, TIM can be paused. In doing so, registration and authentication are retained between tractor and machine.

✓ The TIM status on the working screen is on .

▶ Press .

➔ The TIM functions are paused and must be operated manually via the tractor control units.

The TIM status switches to .

▶ To reactivate the TIM functions, [see Page 150](#).

It is also possible to deactivate only the individual TIM function "Opening and closing tailgate at the end of the tying cycle", e.g. if the machine is in an unfavourable position for ejecting the round bale.

▶ To deactivate the TIM function "Opening and closing tailgate at the end of the tying cycle",

select the checkbox by checking next to the icon .

➔ The checkbox is empty and the TIM function has been deactivated.





➔ In addition the key  appears on the display in order to be able to start tailgate opening and bale ejection manually.

13.11 Operating machine via joystick

13.11.1 Auxiliary functions (AUX)

There are terminals which support the additional function "Auxiliary" (AUX). By means of this function, programmable keys of peripheral equipment (e.g. joystick) can be assigned with functions of the connected job computers. A programmable key can be assigned with several different functions. If key assignments are saved, the display shows corresponding menus when switching on the terminal.

The following functions are available in the "Auxiliary" (AUX) menu:

Icon	Explanation
	<p>For "TIM 1.0" version: Putting down round bales</p>
	<p>Start tying</p>
	<p>Select type of operation for tying: Automatic or manual mode</p>
	<p>Increasing bale diameter</p>
	<p>Reducing bale diameter</p>

13.11.2 Auxiliary assignment of a joystick

INFO

If a joystick on the tractor side is to be configured with functions from the operating terminal, the joystick must feature AUX functionalities.

For further information, see the operating instructions for the terminal and tractor used.

INFO

The examples below represent a recommendation. The assignment of the joystick can be adapted to own desires.

For further information, please refer to the operating instructions of the used terminal.

Recommended assignment of an AUX joystick

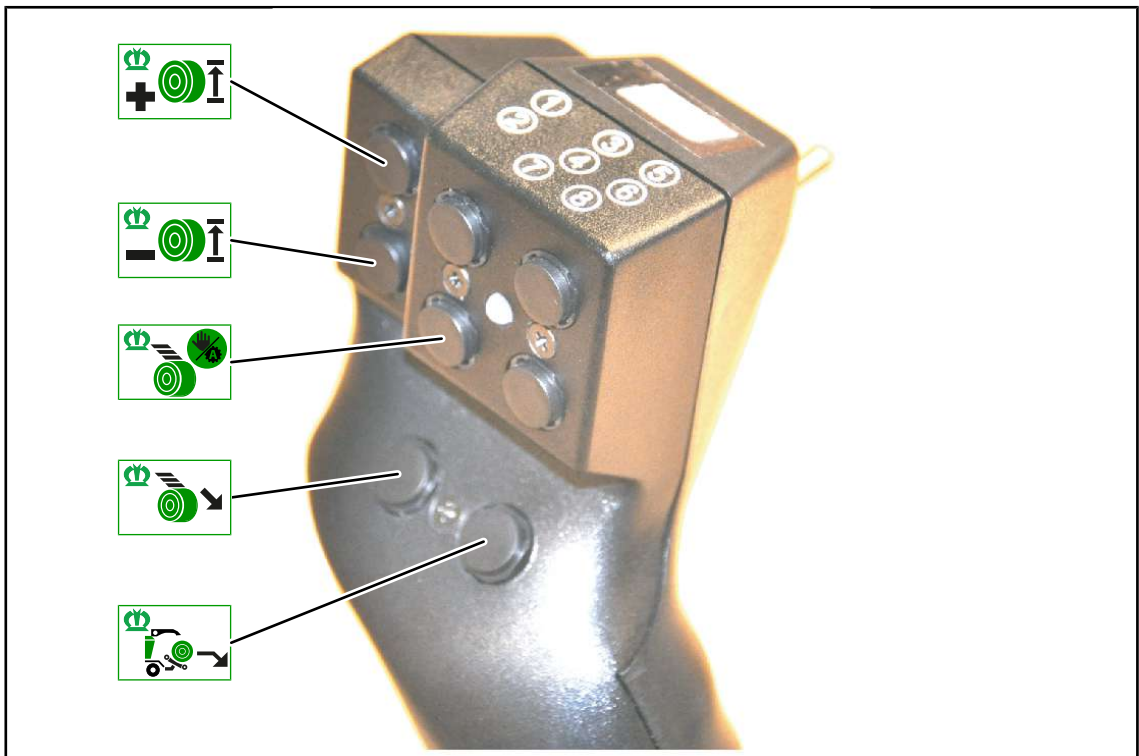

EQG003-040

The keys on the AUX joystick can be assigned on 2 levels.

- ▶ Change between the levels using the switch (2).
- ➔ The LED (1) is lit green or red.

Recommended configuration of an AUX joystick CCI A3

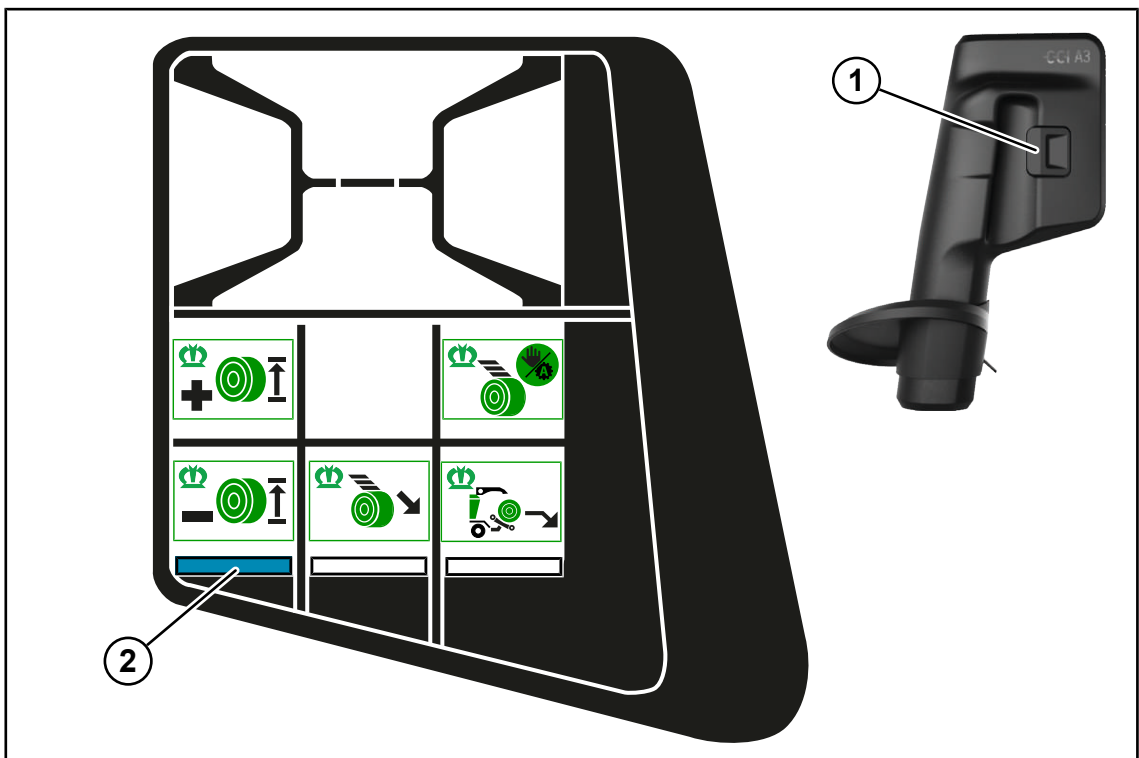

EQG003-143











The indicator lamp (2) shines, showing that operating level 1 is active.

- ▶ Actuate the switch (1) on the rear of the joystick to display the next operating level.

14 Terminal menus

14.1 Menu structure











The menu structure is divided into the following menus depending on the machine configuration.

Menu	Sub-menu	Designation
1 		Number of net layers, see Page 161
1 		Number of twine layers (for "net wrapping and twine tying" version), see Page 161
3 		Pre-signalling, see Page 162
4  		Tying start delay, see Page 162
6 		Electronic baling pressure adjustment, see Page 163
7 		Sensitivity direction display, see Page 164
8 		Selection of tying method (for version with "net wrapping and twine tying"), see Page 165
9 		Filling correction, see Page 166
10 		Manual operation, see Page 167
11 		Correction of start/end position of twine tying (for "net wrapping and twine tying" version), see Page 170
12 		Moisture measurement (for version with "moisture measurement"), see Page 172
	12-1 	Error message for moisture measurement, see Page 172

Menu	Sub-menu	Designation
	12-2 	Correction value for moisture measurement, see Page 173
13 		Counter, see Page 175
	13-1 	Customer counter, see Page 175
	13-2 	Total counter, see Page 177
14 		ISOBUS, see Page 178
	14-5 	KRONE SmartConnect, see Page 179
	14-6 	Configuring TIM software (for "TIM 1.0" version), see Page 180
	14-9 	Switching between terminals, see Page 181
15 		Settings, see Page 182
	15-1 	Sensor test, see Page 183
	15-2 	Actuator test, see Page 187
	15-3 	Software information, see Page 189
	15-4 	Error list, see Page 189

14.2 Recurrent icons

To navigate in the menu level/menus, the following icons appear again and again.

Icon	Designation	Explanation
	Up arrow	Move up to select something.
	Down arrow	Move down to select something.
	Right arrow	Move right to select something.
	Left arrow	Move left to select something.
	Disk	Save the setting.
	ESC	Leave the menu without saving. By pressing the key a little longer, the previously viewed working screen is selected.
	DEF	Reset to factory setting.
	Disk	The mode or value is saved.
	Plus	Increase the value.
	Minus	Reduce the value.

14.3 Selecting a menu Level

▶ To bring up the menu level from the working screen, press .

➔ The display indicates the menu level.

Return from the menu pages to the main menu:

▶ Keep pressing  until the main menu appears.

For an overview of the menus: [see Page 155](#).



14.4 Selecting a menu

Calling up menu

The menus are selected depending on used terminal (touch sensitive or not touch sensitive).

For version with "Touch-sensitive and not touch-sensitive terminal"

By means of adjacent keys

- ▶ To select a menu, press the keys next to  or  until the desired menu is selected.
 - ⇒ The selected menu is highlighted in colour.
- ▶ To call up the menu, press the key next to .
- ➔ The menu opens.

INFO

For version with "Touch-sensitive terminal", the icons can be pressed directly.

By means of the scroll wheel

- ▶ Select the desired menu by means of scroll wheel.
 - ⇒ The selected menu is highlighted in colour.
- ▶ To call up the menu, press the scroll wheel.
- ➔ The menu opens.

For version with touch-sensitive terminal

By pressing the icons

- ▶ To call up a menu, press the icon (e.g. ) in the display.
- ➔ The menu opens.

Leaving the menu

- ▶  or press the adjacent key.
- ➔ The menu closes.



14.5 Changing value

Values must be entered or changed for the settings in the menus. The values are selected depending on used terminal (touch-sensitive or not touch-sensitive).

For version with "Touch-sensitive" and "Not touch-sensitive terminal"

- Via scroll wheel.

Additionally for "Touch-sensitive terminal" version

- By pressing  or .
- By tapping the blue value on the display.
If a numerical value is tapped, an input mask opens. For further information on entering values see the supplied terminal operating instructions.

Examples:**By means of the scroll wheel**





- ▶ Choose the desired value by using the scroll wheel.
⇒ The value is highlighted in colour.
- ▶ Press the scroll wheel.
⇒ An input mask opens.
- ▶ Turn the scroll wheel to increase or reduce the value.
- ▶ Press scroll wheel to save the value.
- ➔ The setting is saved and the input mask closes.

Using the value

- ▶ Tap on the value.
⇒ An input mask opens.
- ▶ Increase or reduce the value.
- ▶ In order to save the value, press .
- ➔ The setting is saved and the input mask closes.

14.6 Changing mode

It is possible to select between different modes in individual menus.

- ▶ To select the next mode, press .
- ▶ To select the previous mode, press .
- ▶ To save, press .
- ➔ An acoustic signal sounds, the set mode is saved and the  icon is briefly displayed in the upper line.
- ▶ To leave the menu, press .

14.7 Tying in the menu level

✓ For The menu level is active, [see Page 157](#).

For the "Net wrapping" version

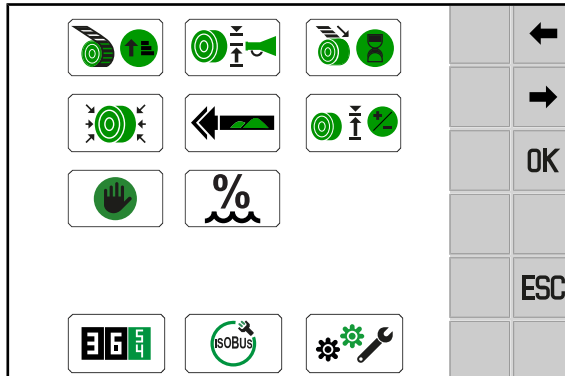

EQG003-008

For the "net wrapping and twine tying" version and selected twine tying

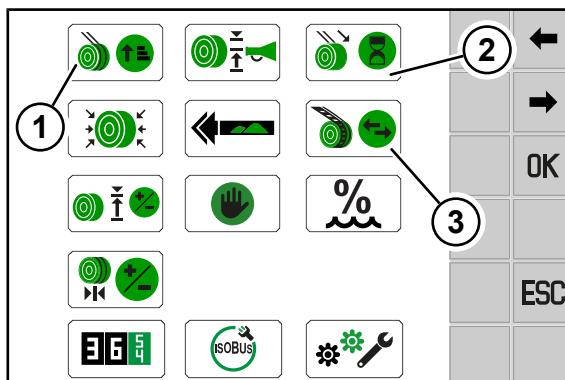

EQG003-043

Depending on the equipment of the machine and the selected tying method, the tying menu items (1), (2) and (3) can look different on menu level.

For the "net wrapping and twine tying" version

Pos.	Icon	Explanation
1		Number of net layers (if net tying type was selected under (3))
		Number of twine layers (if twine tying type was selected under (3))
2		Tying start delay net wrapping (if net tying type was selected under (3))
		Tying start delay twine tying (if twine tying type was selected under (3))
3		Selecting type of tying (net or twine)

14.8 Menu 1 "Number of net layers" (net wrapping)

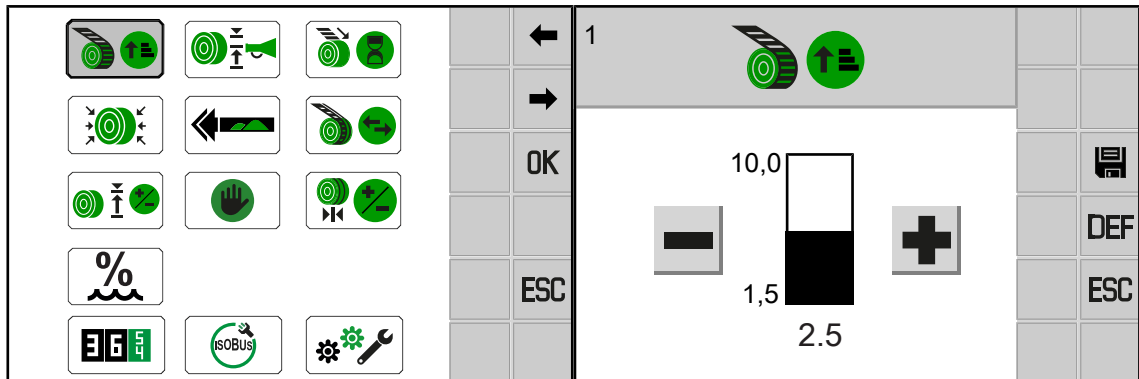

EQG003-000

✓ For The menu level is active, [see Page 157](#).

▶ To open the menu, press

➔ The display shows the "Number of tying material layers" menu.

Selecting the number of tying material layers

▶ Increase or reduce the value, [see Page 158](#).

▶ In order to save the value, press

14.9 Menu 1 "Number of twine layers" (twine tying)

This menu is used to set

- the number of twine layers to be tied around the round bale at the starting position before the twine is routed to the centre,
- the number of twine layers to be tied between the start position and the end position,
- the number of twine layers to be tied around the round bale at the end position before the twine is cut off.

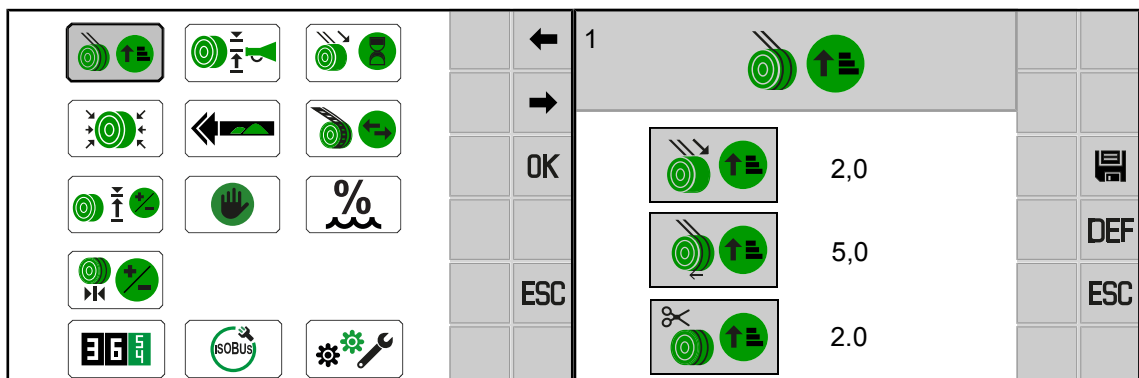

EQG003-046

✓ For The menu level is active, [see Page 157](#).

✓ Twine tying is selected in menu 8 "Type of tying", [see Page 165](#).

▶ To open the menu, press

➔ The display shows the menu "Number of twine layers".

The following values can be set:

Icon	Explanation
	Number of twine layers at the start of twine tying
	Number of twine layers between the start and stop tying cycles
	Number of twine layers at the end of twine tying

Setting the number of twine layers

- ▶ Increase or reduce the value, [see Page 158](#).
- ▶ In order to save the value, press

14.10 Menu 3 "Advance signalling"

Pre-signalling is used to warn if the round bale in the bale chamber is near completion. On the terminal you can set the filling for which pre-signalling starts.

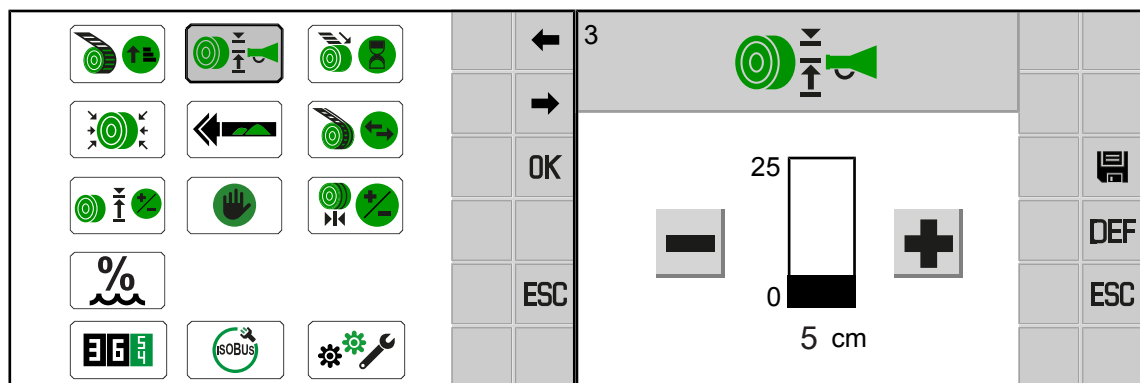

EQG003-002

- ✓ For The menu level is active, [see Page 157](#).
- ▶ To open the menu, press
- ➔ The display shows menu "Advance signalling".

Setting advance signalling

- ▶ Increase or reduce the value, [see Page 158](#).
- ▶ In order to save the value, press

14.11 Menu 4 "Tying start delay"

Tying start delay is used to set the period of time which is required between completion of round bale in the bale chamber and triggering the tying cycle. The tying start delay is set in seconds.

Setting range: 0.0–10 s

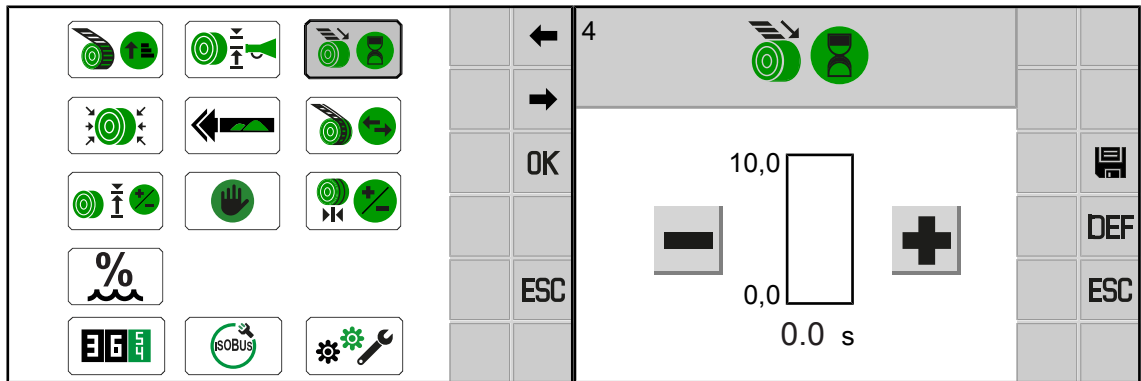

EQG003-003

✓ For The menu level is active, [see Page 157](#).

▶ To open the menu, press .

➔ The display shows the "Tying start delay" menu.

Setting the tying start delay

▶ Increase or reduce the value, [see Page 158](#).

▶ In order to save the value, press

14.12 Menu 6 "Electronic baling pressure adjustment"

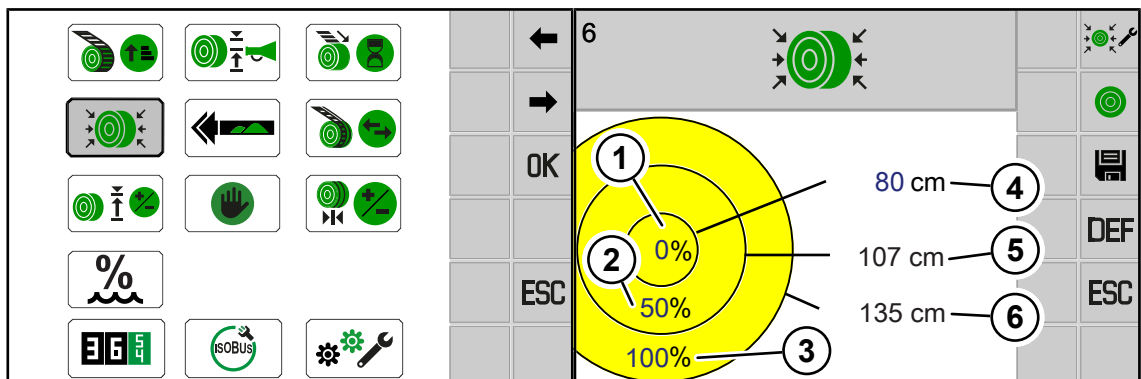

EQG003-016

✓ For The menu level is active, [see Page 157](#).

▶ To open the menu, press .

➔ The display shows the menu "Electronic baling pressure adjustment".

Setting the baling pressure

A different baling pressure can be set for the core, the centre and the edge of the round bale, and a diameter for the core. The following values are possible:

	Baling pressure	Diameter
Core	(1) 0-100 %	(4) up to 80 cm
Middle	(2) 0-100 %	(5) Is calculated automatically from core and edge.
Edge	(3) 0-100 %	(6) Set bale diameter to be set via the working screen, see Page 147 .

▶ Increase or reduce the value, [see Page 158](#).

▶ In order to save the value, press .

Setting the same baling pressure for the entire round bale

▶ Press .

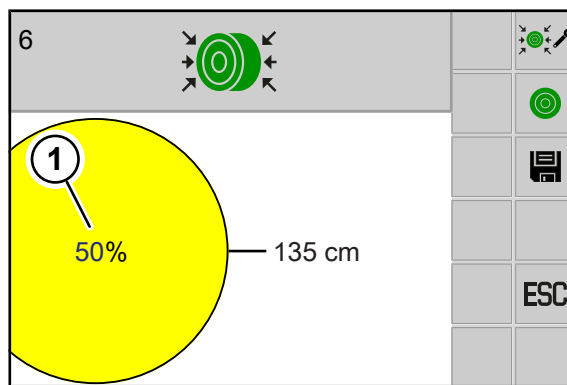

EQ003-304

▶ Enter and save the required value (1) for the baling pressure, [see Page 158](#).

➔ The baling pressure has been set the same for the entire round bale. The bale diameter for the entire round bale is set via the working screen, [see Page 147](#).

Releasing the baling pressure

The baling pressure can be released for maintenance work at the baling belts or in the bale chamber.

▶ Press and keep it pressed for several seconds.

➔ The baling pressure is released and the status is displayed on the key: .

▶ To build up the baling pressure, press and keep it pressed for several seconds.

14.13 Menu 7 “Sensitivity of direction display”

This menu is used to set the sensitivity of the direction display.

The direction display indicates whether the swath is picked up in the centre by the pick-up and provides information about the required direction of travel. The higher the bar on the display, the more sensitive the direction display is set. The higher the sensitivity of the direction display is set, the stronger the motion indication appears in the form of arrows on the working screen.

How the bale chamber is optimally filled by the pick-up, [see Page 77](#).

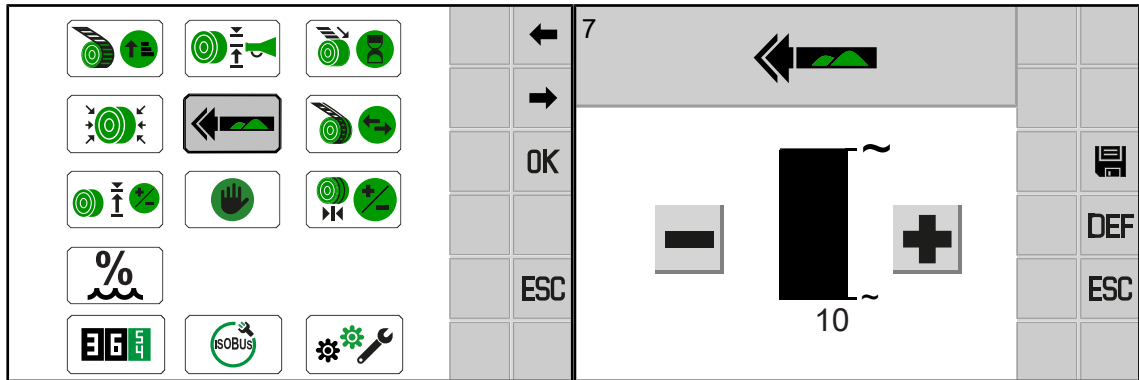

EQG003-017

✓ For The menu level is active, [see Page 157](#).

▶ To open the menu, press .

➔ The display shows the "Sensitivity of direction display" menu.

Setting the sensitivity of the direction display

▶ Increase or reduce the value, [see Page 158](#).

▶ In order to save the value, press .

14.14 Menu 8 "Select type of tying" (for the "Net wrapping and twine tying" version)

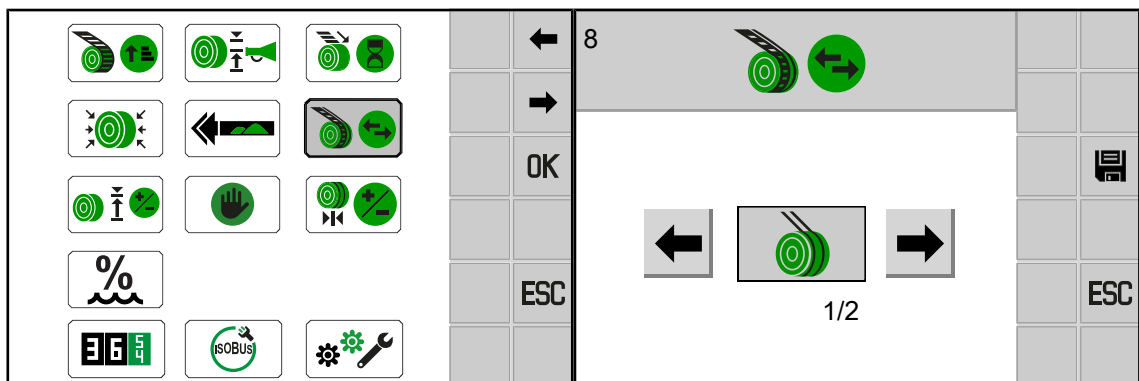

EQG003-005

✓ For The menu level is active, [see Page 157](#).

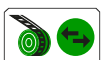
▶ To open the menu, press .

➔ The display shows the "twine tying type selection" menu.

Changing the mode

▶ Select and save the mode, [see Page 159](#).

The following modes can be selected:

Icon	Explanation
	Net wrapping
	Twine tying

14.15 Menu 9 “Filling correction”

If the bale diameter is not reached or is too high, the filling correction can be used to correct the bale diameter within a pre-defined range (bale size -10 to +10 cm).

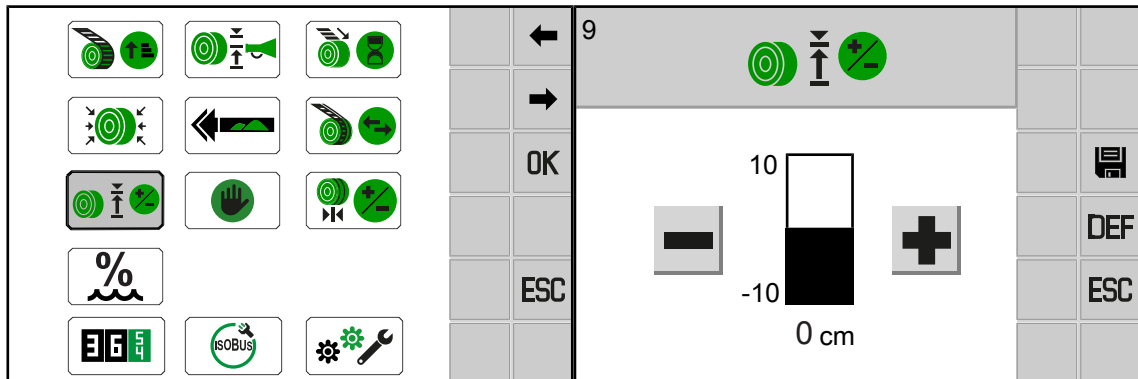

EQG003-018

✓ For The menu level is active, [see Page 157](#).

▶ To open the menu, press

➔ The display shows menu “Filling correction”.

Adjusting the filling correction

▶ Increase or reduce the value, [see Page 158](#).

▶ In order to save the value, press

Example

The set nominal bale diameter is 108 cm.

If the actual bale diameter is only 100 cm, which is 8 cm too small, a correction value of +8 cm must be set.

This means:

Correction value = nominal bale diameter - bale diameter

14.16 Menu 10 "Manual operation" (for the "Net wrapping" version)

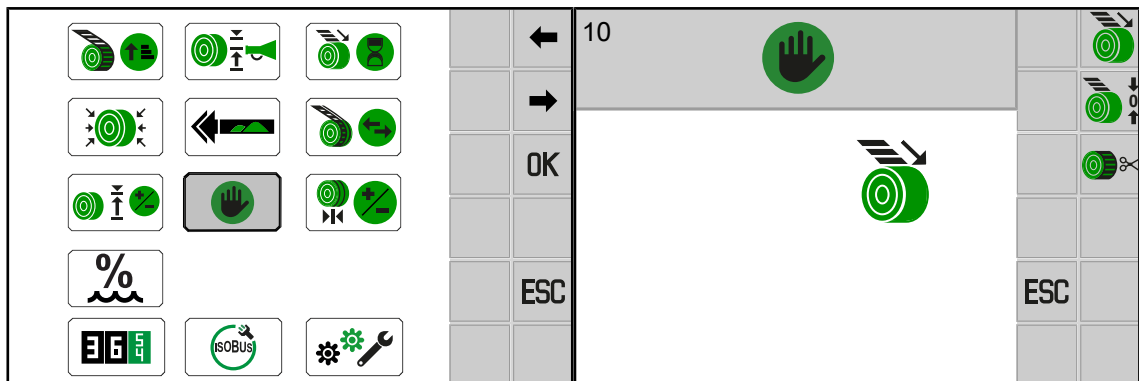





EQG003-006

✓ For The menu level is active, [see Page 157](#).



▶ To open the menu, select .

➔ The display shows the "Manual operation" menu.

The following status displays may appear on the display:

Icon	Explanation
	Net motor is in feed position.
	Net motor is in the tying position.
	Tying actuator is in end position.
	The position is not defined.

Use the keys on the sides to operate the following functions:



Icon	Explanation
	Move actuator for wrapping process to feed position
	Move actuator for wrapping process into tying position
	Moving the tying actuator to the end position

14 Terminal menus

14.17 Menu 10 "Manual operation" (for version with "net wrapping and twine tying")



Moving the tying actuator

- ▶ To move the tying actuator into the feed position, press .
- ▶ To move the tying actuator to the tying position, press .
- ▶ Press  to move the tying actuator the end position.

14.17 Menu 10 "Manual operation" (for version with "net wrapping and twine tying")

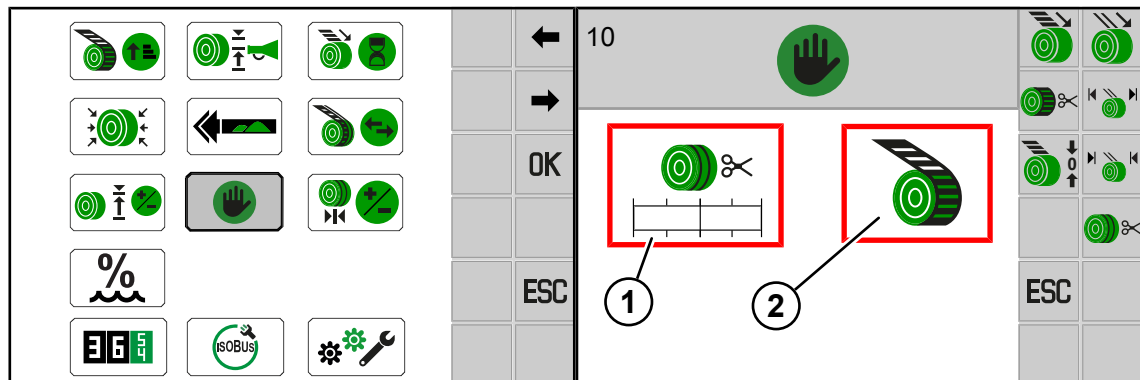





EQG003-115



✓ For The menu level is active, [see Page 157](#).

- ▶ To open the menu, select .
- ➔ The display shows the "Manual operation" menu.





(1) Twine tying

The following status displays may appear on the display:



Icon	Explanation
	Twine arms in feed position.
	Twine arms in start position.
	Twine arms in tying position.
	Twine arms in end position.

Icon	Explanation
	Twine arms in home position.
	Twine tying in undefined position.
	Twine arms cannot be moved because the tying actuator of the net wrapping is not in the end position.



Use the keys on the sides to operate the following functions:

Icon	Explanation
	Moving the twine arms to feed position
	Move twine arms into start position
	Moving the twine arms to end position
	Moving the twine arms to home position

Moving the twine arms

- ▶ Press  to move the twine arms to feed position.
- ▶ Press  to move the twine arms to home position.

Moving the twine arms to start/end position

- ▶ To move the twine arms into the start position, press .
- ▶ Press  to move the twine arms to the end position.

(2) Net tying

The following status displays may appear on the display:

14 Terminal menus

14.18 Menu 11 "Correction of start/end position of the twine tying system (for "net wrapping and twine tying" version)



Icon	Explanation
	Net motor is in feed position.
	Net motor is in the tying position.
	Tying actuator is in end position.
	The position is not defined.
	The actuator for the wrapping process cannot be moved because the twine arms are not in home position.

Use the keys on the sides to operate the following functions:

Icon	Explanation
	Move actuator for wrapping process to feed position
	Move actuator for wrapping process into tying position
	Moving the tying actuator to the end position

Moving the tying actuator

- ▶ To move the tying actuator into the feed position, press
- ▶ To move the tying actuator to the tying position, press
- ▶ Press to move the tying actuator the end position.

14.18 Menu 11 "Correction of start/end position of the twine tying system (for "net wrapping and twine tying" version)

This menu is used to set

- the position on the outer edges of the round bale at which twine tying shall start (start position),
- the position at which twine tying shall stop in the centre of the round bale (end position).

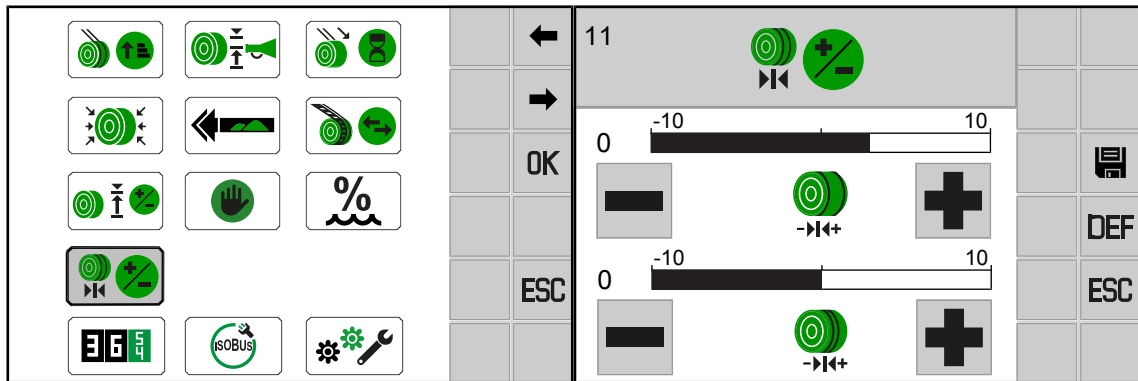



EQG003-114

- ✓ For The menu level is active, [see Page 157](#).
- ✓ Twine tying is selected in menu 8 "Type of tying", [see Page 165](#).

▶ To open the menu, press .

➔ The display shows the "Correcting the twine tying start/end position" menu.

The following settings are possible:

Icon	Explanation
	Set start position. Values between –10 and 10 can be saved. The distance between the outer edge of the bale and the first twine layer is set here. The optimal start position can change as the crops change. Value towards -10: Tying starts further towards the bale centre Value towards 10: Tying starts further towards the outer edge of the bale
	Setting the end position. Values between –10 and 10 can be saved. In doing so, one of the following can be set: either a small stripe without twine tying remains free in the middle of the bale, or twine tying intersects in the middle.

- ▶ Increase or reduce the value, [see Page 158](#).
- ▶ In order to save the value, press .

14.19 Menu 12 "Moisture measurement"

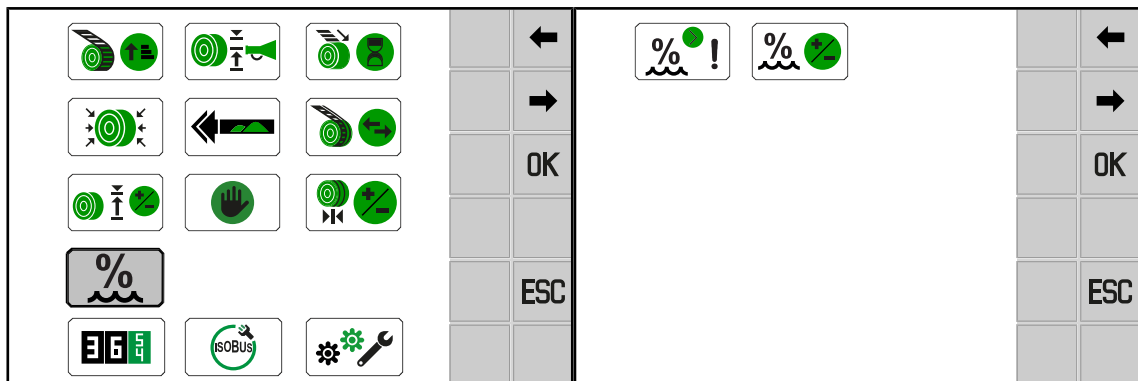



EQG003-112

✓ For The menu level is active, [see Page 157](#).

► To open the menu, select .

➔ The display shows the "Moisture measurement" menu.

The "Moisture measurement" menu is divided into the following menus:

Menu	Sub-menu	Designation
12 		Moisture measurement (for version with "moisture measurement"), see Page 172
	12-1 	Error message for moisture measurement, see Page 172
	12-2 	Correction value for moisture measurement, see Page 173

14.19.1 Menu 12-1 "Error message for moisture measurement"

The error message 522078-15 "Moisture measurement upper limit" warns if the crops are too moist; see chapter "Error list" in the supplement to operating instructions "Error messages". The degree of moisture, i.e. when the error message is to appear, can be selected in this menu.

The error message for the display can also be deactivated or re-activated.

The lower limit value has been permanently set ex works and cannot be changed.

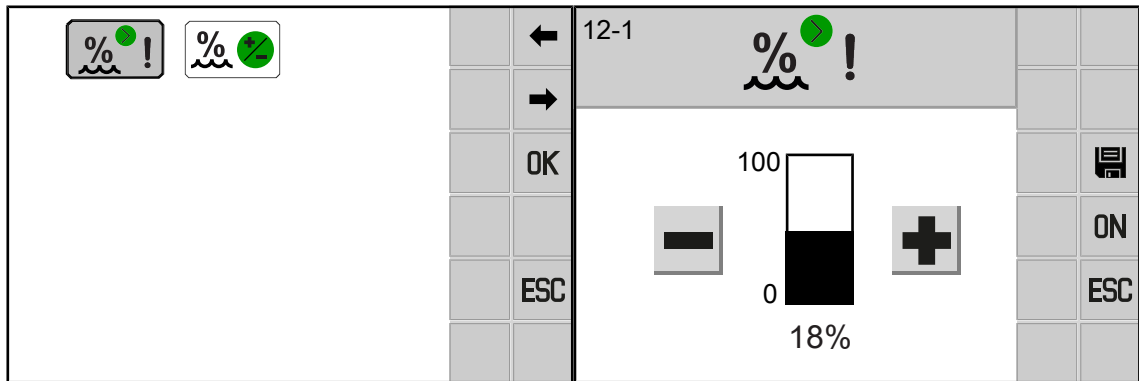

EQG003-141

✓ Menu 12 "Moisture measurement" has been selected.

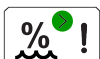
▶ To open the menu, press .

➔ The display shows the "Error message for moisture measurement" menu.



Setting upper limit value

▶ Increase or reduce the value, [see Page 158](#).



▶ In order to save the value, press .

Deactivating/activating error message

▶ In order to deactivate the error message, press .

➔ The display on the key switches from  to .

▶ In order to activate the error message, press .

➔ The display on the key switches from  to .

14.19.2 Menu 12-2 "Correction value for moisture measurement"

In this menu a correction value can be set for the moisture measurement if the displayed value deviates from the value of an external measuring system.

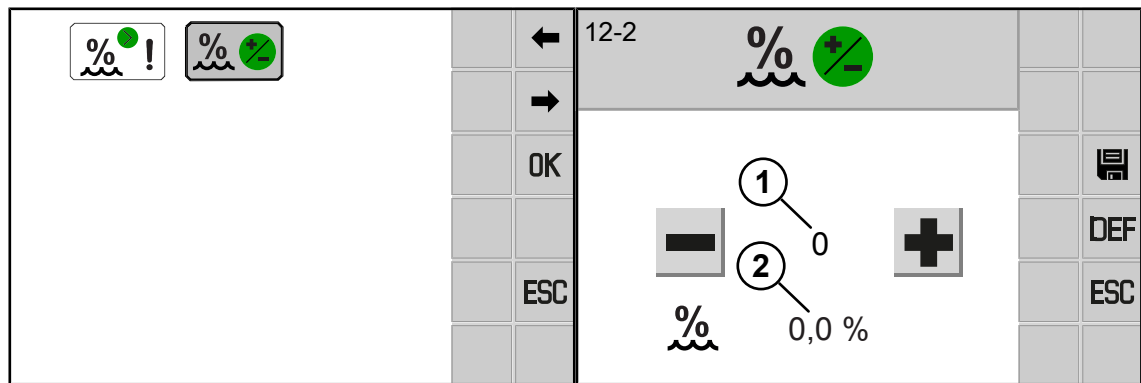

EQG003-142

✓ Menu 12 "Moisture measurement" has been selected.

▶ To open the menu, press .

➔ The display shows the "Correction value for moisture measurement" menu.

Determining the moisture

- ▶ Using a calibrated moisture measuring system, determine the moisture of the crops.
- ➔ If the measured value matches the value (2) on the display, the moisture measurement has been correctly set.
- ➔ If the measured value does not match the value (2) on the display, the correction value (1) must be set.

Setting the correction value (1)

The correction value (1) to be set can be determined as follows:

Value (2) – measured value of the external moisture measuring system = correction value (1)

Values between +10 and -10 can be set.

▶ Increase or reduce the value, [see Page 158](#).

▶ In order to save the value, press .

14.20 Menu 13 "Counters"

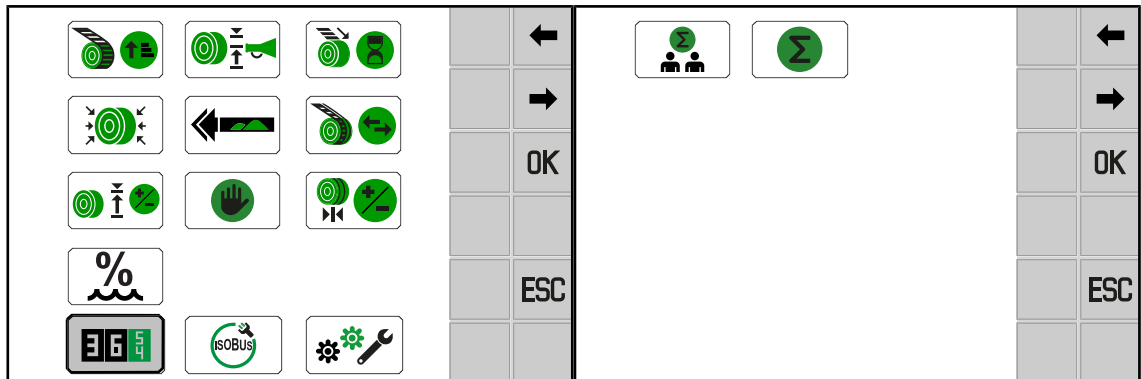

EQG003-011

✓ For The menu level is active, [see Page 157](#).

▶ To open the menu, press .

➔ The display shows the menu "Counter".

The "Counter" menu is divided into the following submenus:

Menu	Sub-menu	Designation
13 		Counter, see Page 175
	13-1 	Customer counter, see Page 175
	13-2 	Total counter, see Page 177

14.20.1 Menu 13-1 "Customer counter"

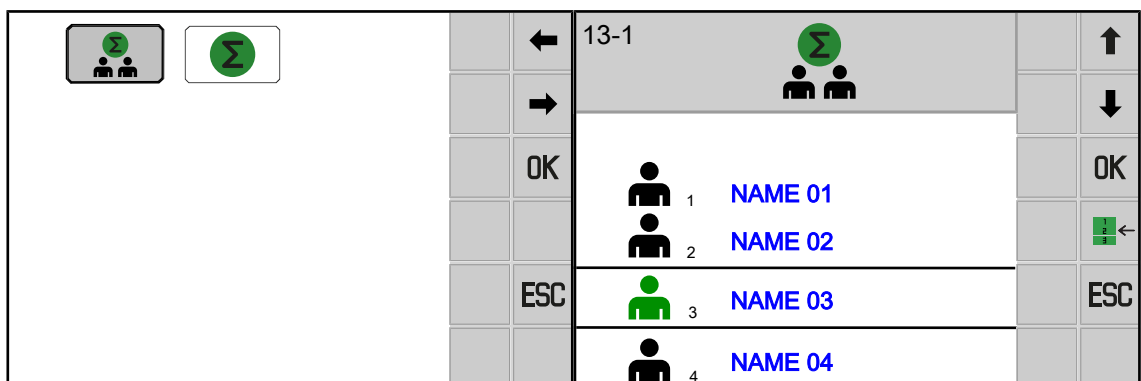

EQ003-054 / EQ003-228

✓ Menu 13 "Counter" is called. [see Page 175](#).

▶ To open the menu, press

➔ The display shows menu 13-1 "Customer counter".

The menu displays a customer list. The names shown in blue can be adjusted, [see Page 158](#).

- ▶ Navigate through the customer list using or .
- ▶ To activate a customer counter, navigate to the required customer and press .
- ➔ The required customer counter is shown as: .
- ▶ To open the detailed view of a customer, navigate to the required customer and press .

Detailed view of a customer

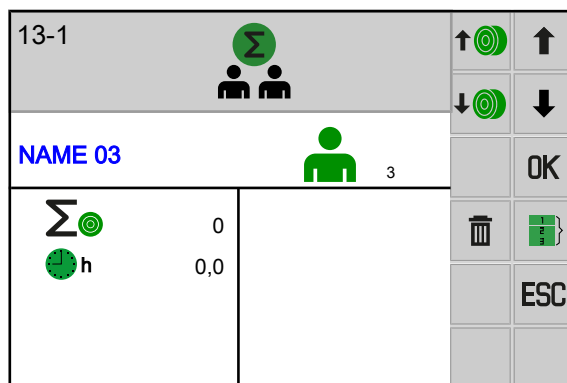





EQG003-106

The icons displayed in the menu have the following meaning:

Icon	Explanation
	Activated customer counter 1 ... 20
	Total of pressed round bales for the respective customer
	Operating hours counter for the corresponding customer



Use the keys on the sides of the terminal to operate the following functions:

Icon	Explanation
	Increase number of bales
	Reduce number of bales
	Setting displayed customer counter to zero

Icon	Explanation
 	Navigating between the detailed views of the customers
	Activating displayed customer counter
	Returning to the complete overview of all customers

Changing the number of bales













The number of bales can be manually changed in the customer counter. The particular customer counter does not have to be activated for this.

- ▶ To increase the number of bales, press .
- ▶ To reduce the number of bales, press .

Setting customer counters to zero

- ▶ To set the customer counter to zero, hold down  for at least 2 seconds.

14.20.2 Menu 13-2 "Total counter"

			13-2			
		OK		 h		 1
			0	0		 2
	ESC	 1	0	0		ESC
		 2	0	0		

EQG003-013

✓ Menu 13 "Counter" is called. [see Page 175](#).

▶ To open the menu, press .

➔ The display shows menu 13-2 "Total counter".

The icons that appear in the working screen have the following meaning:

Icon	Explanation
	Total counter (cannot be deleted)
	Season counter 1 (can be deleted)
	Season counter 2 (can be deleted)
	Total of pressed round bales
	Operating hours counter

Use the keys on the sides of the terminal to operate the following functions:

Icon	Explanation
	Setting season counter 1 to zero
	Setting season counter 2 to zero

Set season counter 1 or 2 to zero

- ▶ To set season counter 1 to zero, press .
- ▶ To set season counter 2 to zero, press .

14.21 Menu 14 "ISOBUS"

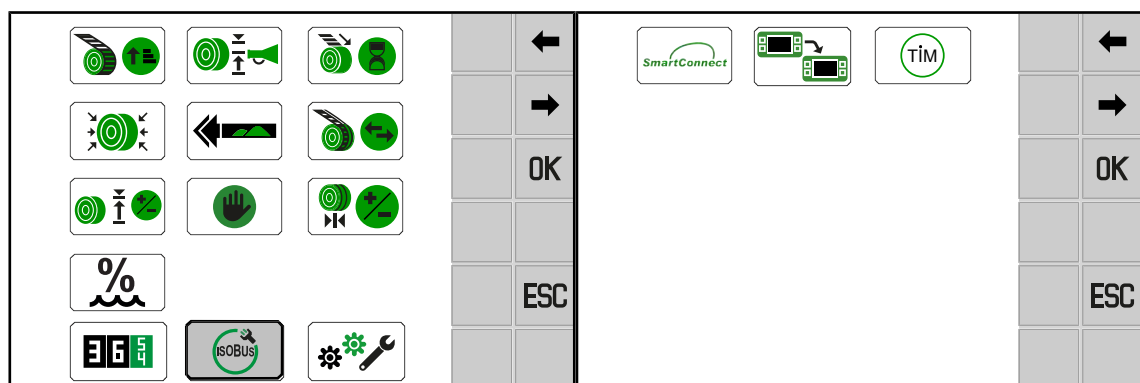





EQG003-014

✓ The menu level is open, [see Page 157](#).

▶ To open the menu, press .

➔ The display shows the "ISOBUS" menu.

Depending on the machine equipment, the "ISOBUS" menu is divided into the following submenus:

Menu	Sub-menu	Designation
14 		ISOBUS, <i>see Page 178</i>
	14-5 	KRONE SmartConnect, <i>see Page 179</i>
	14-6 	Configuring TIM software (for "TIM 1.0" version), <i>see Page 180</i>
	14-9 	Switching between terminals, <i>see Page 181</i>

14.21.1 Menu 14-5 "KRONE SmartConnect"

The access data for the KRONE SmartConnect (KSC) can be seen in this menu.

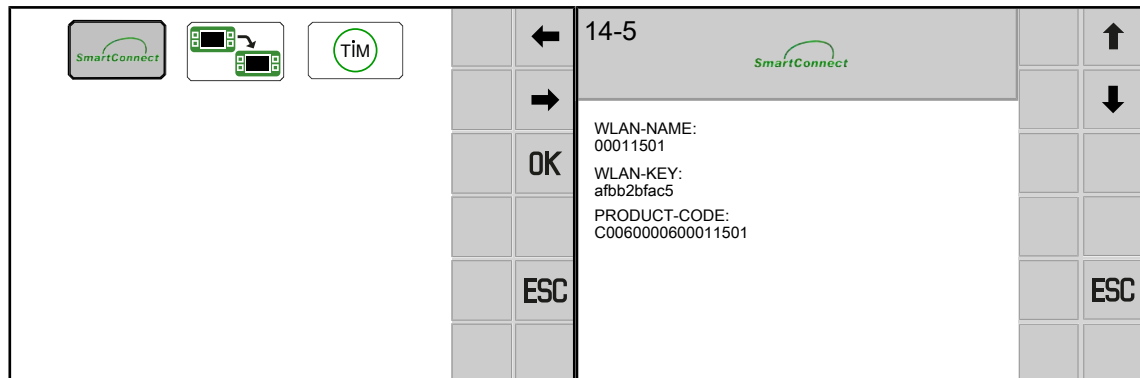

EQG000-064

- ✓ One or more KRONE SmartConnects have been installed.
- ✓ The menu 14 "ISOBUS" has been selected, *see Page 178*.
- ▶ To open the menu, press .
- ➔ The display shows the "SmartConnect" menu.

14.21.2 Menu 14-6 "Configuring TIM software" (for "TIM 1.0" version)

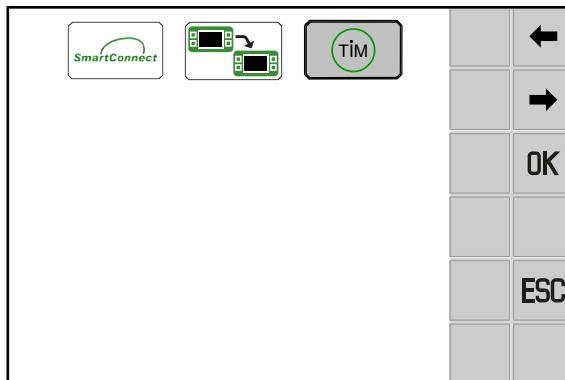

EQG003-015

✓ The menu 14 "ISOBUS" has been selected, [see Page 178](#).

▶ Select to open the menu.

➔ The display shows the "Configuring TIM Software" menu.

The following displays are in the menu:

	TIM function "Stop tractor when the tying cycle starts".
	TIM function "Opening and closing tailgate at the end of the tying cycle".
	Control unit number of the tractor which is used to open and close the tailgate.
Brand: Model: Function Instance:	When a tractor has logged into the ISOBUS system, the designations and the type of tractor appear here.

The keys can be used to operate the following functions. If the key is greyed out, the function is not available.

Icon	Explanation
	The tractor is not connected to the machine via TIM. If TIM functions have been selected, the key switches to
	Start registration and authentication of the TIM functions.
	Start TIM functions (can be selected only when tailgate closed).
	Stop TIM functions. In doing so, registration and authentication are also disconnected between tractor and machine.
	Pause TIM functions. In doing so, registration and authentication are not disconnected between tractor and machine.

Selecting TIM functions

- ▶ Select the checkbox next to the icon and/or .
- ▶ Select and input the control unit number of the tractor, [see Page 158](#).
- ▶ To start establishing a connection between tractor and machine, press .
- ➔ Registration and authentication of the TIM functions are started.

Connecting machine and tractor to each other

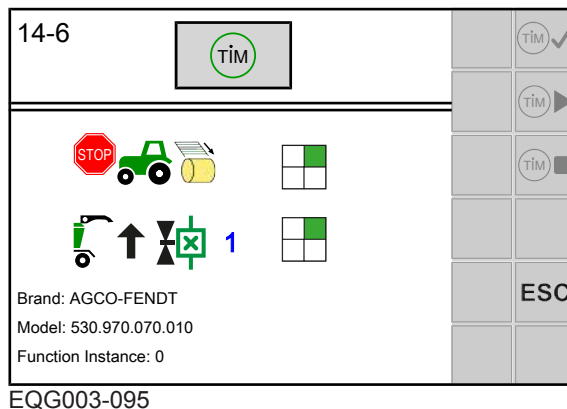

When the TIM functions have been preselected, the checkboxes disappear and the TIM

status is indicated on the display. The machine is being registered and authenticated with the tractor.

The TIM status switches to .

- ▶ To activate TIM on the machine, press the key .
- ➔ The TIM status switches to . The machine waits for confirmation of the tractor.
- ▶ Confirm the TIM activation on the terminal or on another control panel on the tractor.
- ➔ The TIM status switches to . The machine automatically takes over control of the TIM functions on the tractor, [see Page 148](#).

14.21.3 Menu 14-9 "Switching between terminals"

INFO

This menu is only available if several ISOBUS terminals are connected.

When the user switches terminals for the first time, the configuration of the machine is loaded into the next terminal. The loading process can take a few minutes. The configuration is stored in the memory of the next terminal.

Up to the next call, the machine is no longer available in the previous terminal.

When restarting, the system tries to start on the terminal last used. If the terminal last used is no longer available (e.g. because it was dismantled), the restart is delayed because the system searches for a new terminal and loads the specific menus into that terminal. The loading process may take several minutes.

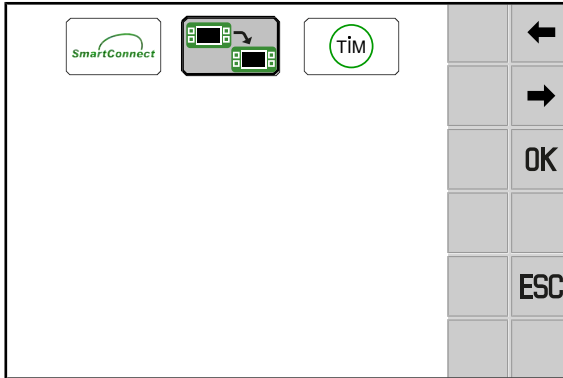

EQG003-035

✓ The menu 14 "ISOBUS" has been selected, [see Page 178](#).

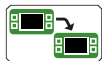
▶ To change to the next terminal, press .

14.22 Menu 15 "Settings"

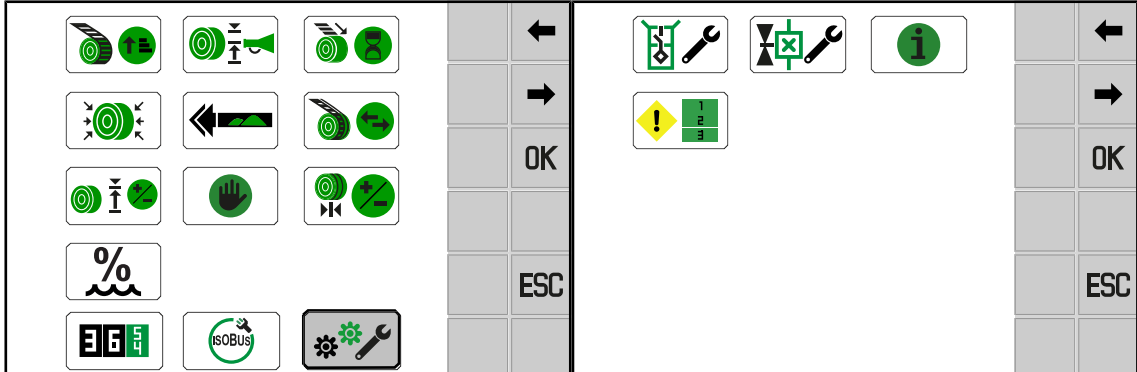





EQG003-036

✓ For The menu level is active, [see Page 157](#).

▶ To open the menu, select .

➔ The display shows the "Settings" menu.

The "Settings" menu is divided into the following submenus:

Menu	Sub-menu	Designation
15 		Settings, see Page 182
	15-1 	Sensor test, see Page 183
	15-2 	Actuator test, see Page 187
	15-3 	Software information, see Page 189
	15-4 	Error list, see Page 189

14.22.1 Menu 15-1 "Sensor test"

 **WARNING**

Danger of injury in the danger zone of the machine

If the PTO shaft runs during the sensor test, machine parts may start to move unintentionally. Thus there is a risk of serious injuries or death.

▶ Turn off PTO shaft.

In the sensor test, the sensors installed on the machine are checked for faults. Furthermore the sensors can be correctly set in the sensor test. There is no guarantee the machine is working correctly until after the sensors have been adjusted.

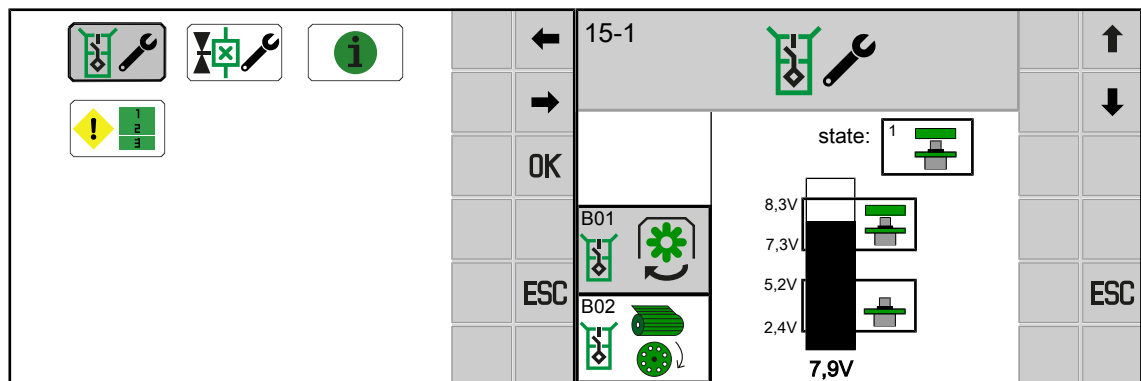

EQG003-030

✓ Menu 15 "Settings" is called, [see Page 182](#).

▶ To open the menu, press .

➡ The display shows the "Sensor test" menu .

The following keys can be available in the menu:

Icon	Designation
	Choose previous sensor
	Choose next sensor
	Exit menu

Settings for inductive proximity switches (NAMUR):

The minimum and maximum setting value with attenuated sensor (metal in front of the sensor) are shown in the upper part of the bargraph. The current setting value (actual value) is displayed under the bar display.

The distance from the sensor to the metal must be adjusted so that in the attenuated state the bar is in the upper marking. Then check whether the bar is in unattenuated state in the lower marked area.

Possible sensors (depending on the machine configuration)

An overview of the sensors, actuators and control units is in the circuit diagram.

No.	Sensor	Designation
B01		Speed of bale chamber
B02		Tying process active
B06		Rotational speed deflection roll twine left side (for version "Net wrapping and twine tying")
B07		Rotational speed deflection roll twine right side (for version "Net wrapping and twine tying")
B08		Blade cassette up
B09		Filling indicator
B11		Tailgate lock hook left
B12		Tailgate lock hook right
B15		Bale ejection
B61		Tying 1 (passive)
B63		Position tying mechanism twine (for version "Net and twine tying")

No.	Sensor	Designation
B67		Blade pre-selection active
B68		Blade pre-selection inactive
B69		Blade active
B82		Direction indicator
B83		Overload protection baling belts

Possible status displays of the sensors

Icon	Designation
0 OK	Sensor ready for operation
1	Sensor attenuated (metal in front of the sensor)
2	Sensor unattenuated (no metal in front of the sensor)
7	Cable break or short circuit
8 Error	Defective sensor or job computer
20	Cable break
21	Short circuit

14.22.1.1 Adjusting sensor B08 "Top blade cassette"

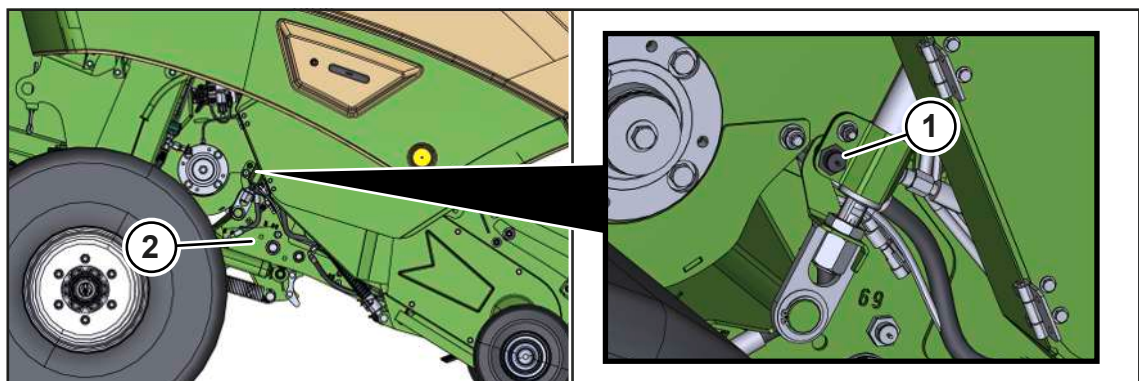

RPG001-241

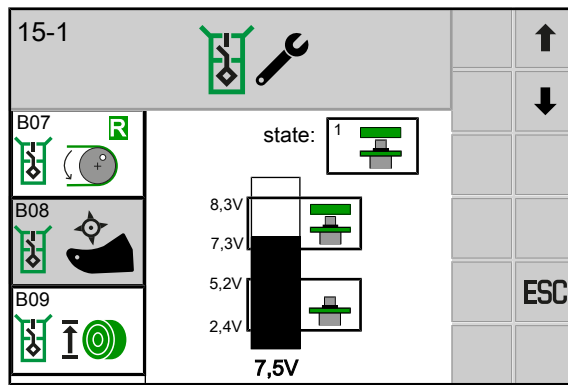

EQG003-145

The sensor B08 "Blade cassette up" (1) sits on the right machine side in the lower area.

- ✓ The machine has been shut down and secured, [see Page 28](#).
- ▶ Remove contamination from the area of the blade cassette (2).
- ▶ Adjust the distance between the sensor (1) and the metal such that the black bar in menu 15-1 "Sensor test" is in the upper marking when the sensor is attenuated.
- ▶ Check whether the black bar is in the lower marking when the sensor is unattenuated.

14.22.1.2 Adjusting sensor B61 "Tying 1 (passive)"

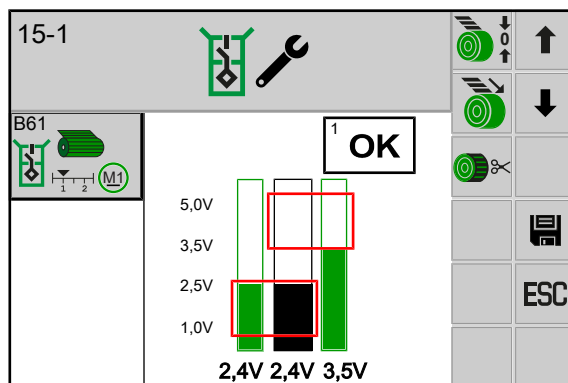

EQ003-106

- ✓ Menu 15-1 "Sensor test" is open.
- ✓ The sensor B61 "Tying 1 (passive)" has been selected.

Saving is only possible when the bar is in the lower or upper red rectangle of the bargraph.

For details of the positions of the feed rocker arm, [see Page 252](#).

- ▶ Approach the end position of the feed rocker arm by clicking on
- ▶ When the bar is in the red rectangle, save the position by clicking on
- ▶ Approach the feed positions of the feed rocker arm by clicking on
- ▶ When the bar is in the red rectangle, save the position by clicking on
- ▶ Approach the tying position of the feed rocker arm by clicking on
- ▶ Check the tying position on the machine, [see Page 252](#).

14.22.2 Menu 15-2 "Actuator test"

WARNING

Risk of injury due to non-observance of the safety routines

If the relevant safety routines are not observed, persons may be seriously injured or killed.

▶ The safety routines must be read and observed to avoid accidents, [see Page 28](#).

The actuator test is used to test the actuators installed on the machine. An actuator can only be tested when current is flowing through it. Therefore, in the "Actuator test" menu, the actuator must be controlled manually for a short time in order to determine possible errors in the actuator system.

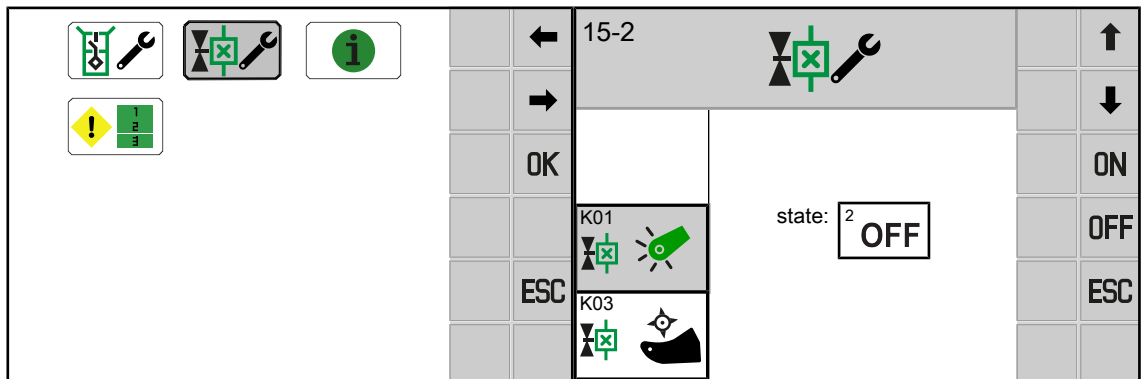

EQG003-031







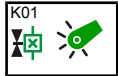

- ✓ Menu 15 "Settings" is called, [see Page 182](#).
- ▶ To open the menu, press .
 - ⇒ A warning opens which refers to the operating instructions.
- ▶ Observe the safety routine "Run actuator test", [see Page 30](#).
- ▶ Confirm with **OK**.
- ➔ The display shows the "Actuator test" menu.

The following keys can be available in the menu:

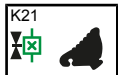
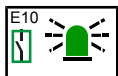

Icon	Designation
	Choose previous sensor
	Choose next sensor
ON	Switching on the actuator
OFF	Switch off the actuator
ESC	Exit menu

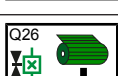
Possible actuators (depending on how the machine is equipped)

An overview of the sensors, actuators and control units is in the circuit diagram.

No.	Actuator	Designation
K01		Pick-up
K03		Raising/lowering blade cassette
K21		Blade control shaft A active
E10		Warning beacon (for certain countries)
E20/ E23/ E34		Maintenance lighting for net roll and side hood right
E22/ E33		Maintenance lighting side hood left
M03		Motor tying 3 (for "net wrapping and twine tying" version)
Q26		Lowering the feed rocker arm
Q27		Lifting the feed rocker arm
Q41		Baling pressure

Possible status displays of the actuators

Icon	Designation
1 ON	Actuator ON
2 OFF	Actuator OFF
3 	General actuator error
4 FUSE 	No supply voltage Possible cause: Fuse defective.

Diagnostics for digital actuators

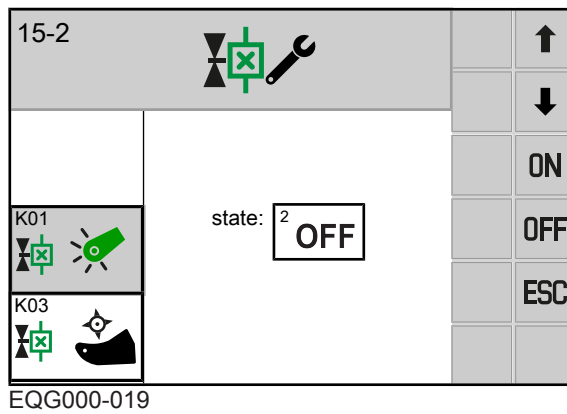

Errors are only displayed if the actuator is turned on and a test for the actuator in question is available. The LED on the plug can also be checked directly on the actuator.

- ▶ Press **ON** to switch the actuator on.
- ▶ Press **OFF** to switch the actuator off.

14.22.3 Menu 15-3 "Software info"

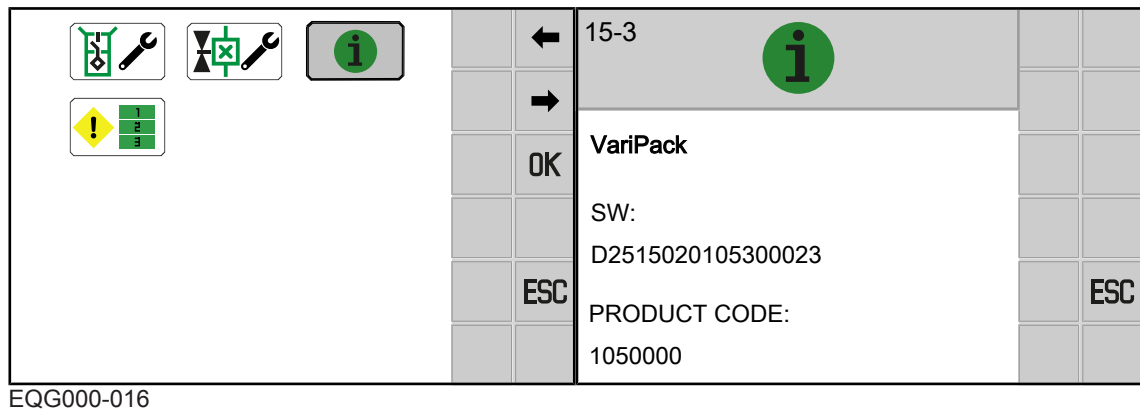

✓ Menu 15 "Settings" is called, [see Page 182](#).

- ▶ To open the menu, press .
- ➔ The display shows the "Software info" menu.

Display area

Icon	Designation
SW	Overall software version of the machine

14.22.4 Menu 15-4 "Error list"

All active and non-active errors are shown in this menu. The errors are shown with a number indicating how often the error occurred and the time on the operating hours counter when the error last occurred.

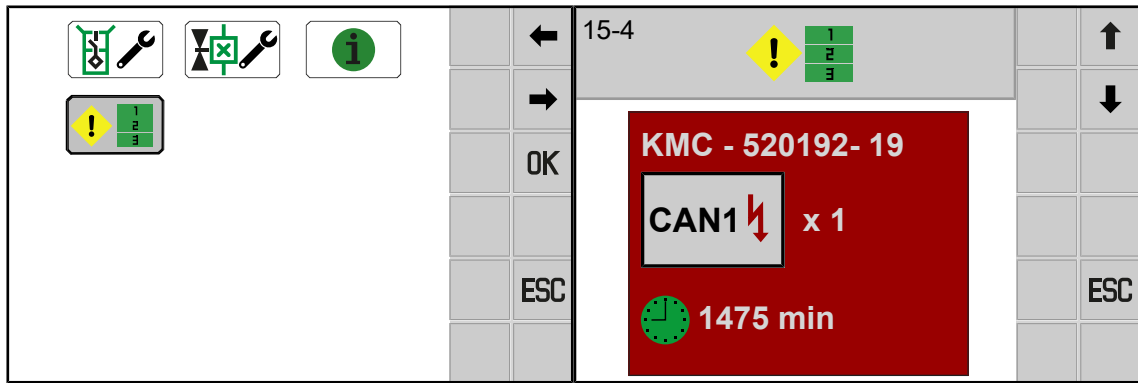

EQG000-060

✓ Menu 15 "Settings" is called, [see Page 182](#).

▶ To open the menu, press

➔ The display shows menu "Error list".

Display area

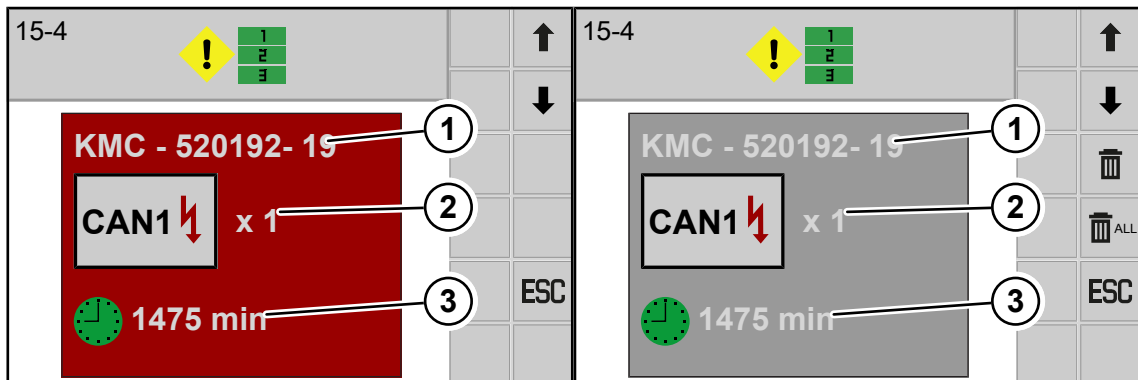



EQ001-085 / EQ001-209

Icon	Designation	Explanation
	Active error	<ul style="list-style-type: none"> Cannot be deleted
	Non-active error	<ul style="list-style-type: none"> Can be deleted
(1)	Error number	<ul style="list-style-type: none"> Meaning, cause and remedy of error message see Page 251.
(2)	Number	<ul style="list-style-type: none"> How often the error has occurred.
(3)	Operating hours counter time	<ul style="list-style-type: none"> The time on the operating hours counter when the error last occurred.
	Delete individual errors	<ul style="list-style-type: none"> The selected error is deleted. Only non-active errors can be deleted.
	Delete all errors	<ul style="list-style-type: none"> All inactive errors are deleted.

Recurring icons [see Page 156](#).

Delete individual errors

Only non-active errors (highlighted grey) can be deleted.

▶ To select the error to be deleted, press  or .

▶ To delete the error, press .

Delete all errors

Only non-active errors (highlighted grey) can be deleted.

▶ To delete all errors, press .

15 Driving and transport

WARNING

Risk of injury due to non-observance of relevant safety notices

If the relevant safety notices are not observed, persons may get seriously injured or killed.

- ▶ To avoid accidents, the basic safety instructions must be read and observed, [see Page 16](#).

WARNING

Risk of injury due to non-observance of safety instructions

If the relevant safety routines are not observed, persons may be seriously injured or killed.

- ▶ The safety routines must be read and observed to avoid accidents, [see Page 28](#).

WARNING

Risk of accident from open stop cocks

Machine components could be moved unintentionally when stop cocks are open. This may result in serious accidents.

- ▶ In order to avoid that functions are triggered by mistake, the stop cock/s must be closed during transport/road travel.

WARNING

Risk of accident when cornering with a hitched machine

When cornering, the hitched machine swings out further than the tractor. This may result in accidents.

- ▶ Consider the larger swivel range.
- ▶ Consider people, oncoming traffic and obstacles when turning.

WARNING

Risk of accident caused by non-locked regulating valves of tractor

When regulating valves are not locked, machine components could be activated unintentionally. This may result in serious accidents.

- ▶ To avoid that functions are triggered by mistake, the regulating valves of the tractor must be in neutral position when performing transport journeys on the road and must be locked.

NOTICE

Dangers from an automatic anti-jack-knife brake system on the tractor

In some cases, the braking behaviour of a machine connected to a tractor with continuously variable transmission that is equipped with an automatic anti-jack-knife brake system can negatively be influenced. If such an automatic anti-jack-knife brake system is activated for a longer period of time, e.g. on long downhill sections, it can overheat, which significantly reduces the braking performance of the machine brakes.

In addition, using an automatic anti-jack-knife brake system can lead to a significantly higher wear on the machine brakes.

15.1 Preparing the machine for road travel

- ✓ All items listed in chapter "Start-up" have been fulfilled, [see Page 59](#).
- ✓ The control units on the tractor are in neutral position and locked.
- ✓ The machine has been shut down and secured, [see Page 28](#).
- ✓ All guards are properly closed and locked.
- ✓ The wheel chocks are secured in the supports / holders on the machine, [see Page 82](#).
- ✓ The support jack is in the transport position, [see Page 79](#).
- ✓ Ladders for the tying system have been folded up, [see Page 82](#).
- ✓ The road lighting has been connected, tested and is functioning properly, [see Page 63](#).
- ✓ The pick-up is fully raised in transport position, [see Page 84](#).
- ✓ **For "guide wheel support" version (only for certain countries):** The guide wheel on the right machine side is removed and mounted at the drawbar, [see Page 195](#).
- ✓ The bale chamber is empty and the tailgate is closed.
- ✓ Soiling and crop residue have been removed from the machine, in particular from the lighting and identification elements.
- ✓ The tyres have no cuts and breaks.
- ✓ The tyre pressure is correct, [see Page 51](#).
- ✓ The brake is functioning properly.
- ✓ **With "Parking brake" version:** The parking brake is released, [see Page 81](#).
- ✓ The permitted maximum speed of the machine is known and is maintained.
- ✓ The permitted weights of the machine are observed, [see Page 50](#).
- ✓ **For version with "Operation unit DS 100":** The road travel screen has been called up, [see Page 110](#).
- ✓ **For the remaining terminals:** The road travel screen has been called up, [see Page 147](#).

15.2 Parking the machine

 **WARNING**

Risk of injury due to the unsecured machine rolling away

If the machine is not secured against rolling away when it has been switched off, there is a risk of people being injured by the machine rolling away in an uncontrolled manner.

- ▶ Secure the machine against rolling using wheel chocks.
- ▶ Before uncoupling the machine from the tractor, completely close the tailgate.
- ▶ Shut down and safeguard the machine, [see Page 28](#).
- ▶ Bring the support jack in support position, [see Page 79](#).
- ▶ On the tractor side, loosen the supporting chain of the universal shaft, disengage the universal shaft, place it on the universal shaft support in case of lower suspension or suspend it from the universal shaft chain in case of upper suspension.
- ▶ Loosen the hitching device as specified in the operating instructions of the tractor manufacturer.
- ▶ When using a safety chain as an additional safety precaution for trailed implements: Remove the safety chain.
- ▶ Disconnect the road lighting plug, [see Page 63](#).
- ▶ Remove the power supply cable for the terminal.

- ▶ Disconnect the hydraulic hose lines and hook them into the support at the machine.
- ▶ Drive the tractor away carefully.
- ▶ Fit the safety device which prevents unauthorised use and keep the key in a safe place, [see Page 83](#).

15.3 Securing the universal shaft

If the universal shaft is not connected to the tractor, it must be secured on the drawbar with the universal shaft retaining chain or with the universal shaft bracket.

With top suspension of the drawbar

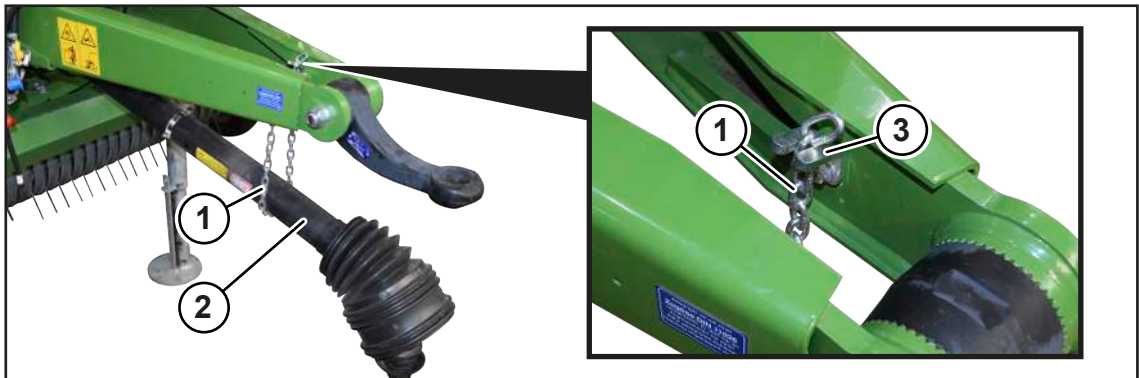

RPG000-118

- ▶ Insert the universal shaft (2) into the universal shaft chain (1).
- ▶ Attach the universal shaft chain (1) to the support (3).

With bottom suspension of the drawbar

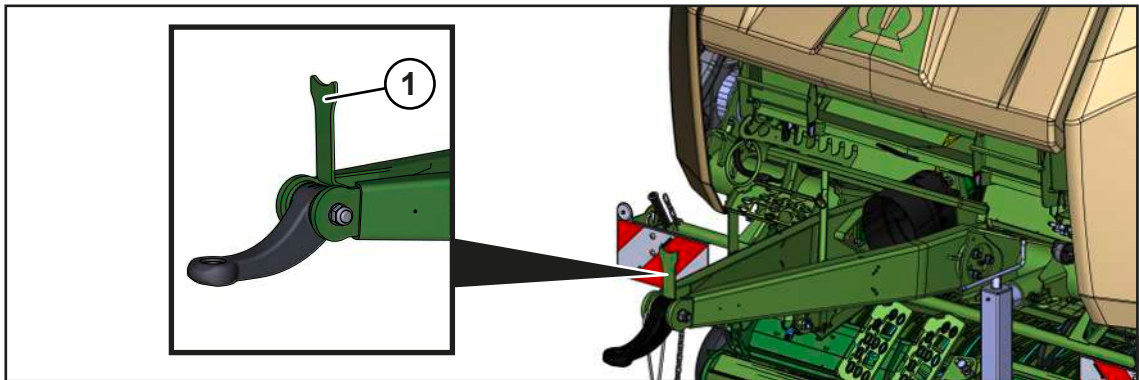

RPG000-137

- ▶ Fold out the universal shaft bracket (1) and place the universal shaft on the universal shaft bracket (1).

15.4 Checking road travel lighting

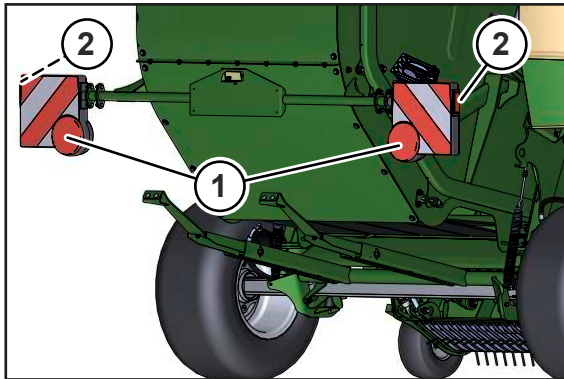

RPG000-073

- ▶ Connecting road travel lighting to the vehicle electrical system, [see Page 63](#).
- ▶ Check whether the rear lamps (1) are functional.
- ▶ Clean the rear lamps (1) and the side reflectors (2).

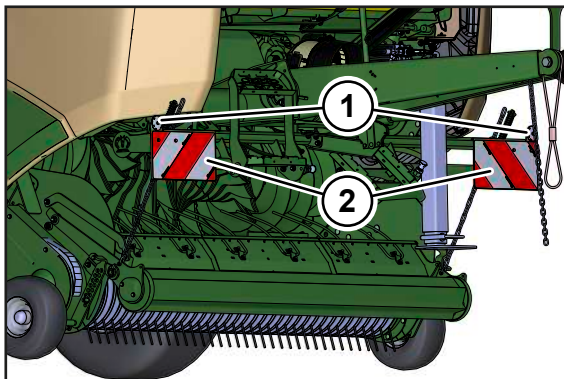

RPG000-074

- ▶ Clean the 2 reflectors (1) and the warning panels (2).

15.5 Dismounting the guide wheels of the pick-up for road travel

For "guide wheel support" version (only for certain countries)

For road travel, you can remove the guide wheel of the pick-up on the right-hand side of the machine to reduce the overall width of the machine to less than 2.55 m (depending on the currently installed tyres). Next, mount it on the drawbar for storage.

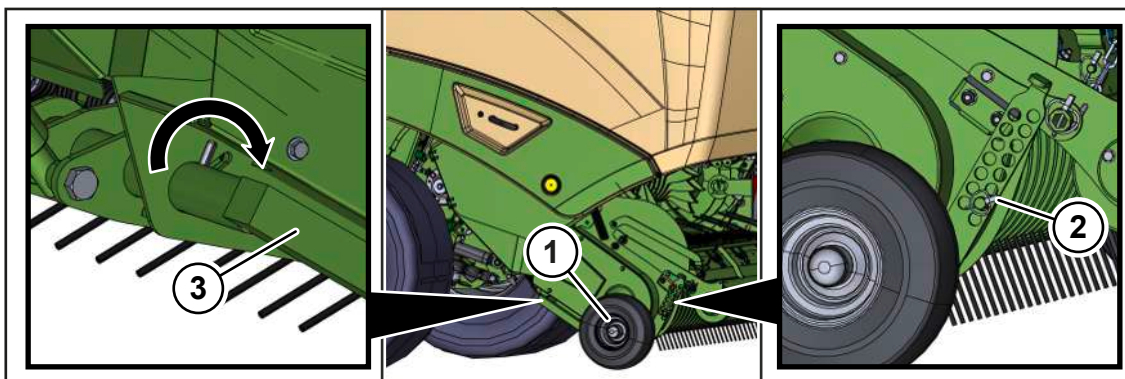

RPG000-239

- ▶ Lift the pick-up into the transport position, [see Page 84](#).
- ▶ Shut down and safeguard the machine, [see Page 28](#).
- ▶ To dismount the guide wheel (1), remove the linch pin (2).
- ▶ Rotate the holding arm (3) of the guide wheel (1) in the direction of the arrow and remove the guide wheel (1) together with the holding arm (3).
- ▶ Hold the guide wheel (1) at the handle (3) and pull it out in the direction of the arrow.
- ▶ Use the same procedure to dismount the guide wheel on the right-hand machine side.

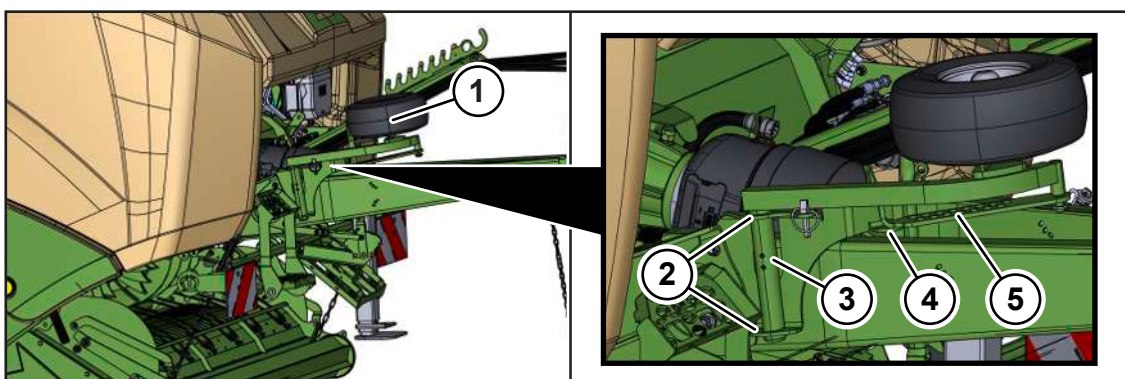

RPG001-240

- ▶ Insert the holding arm (3) of the guide wheel (1) into the boreholes (2) of the guide wheel support.
- ▶ Move the perforated bar (5) so that the perforated bar (5) rests on the support (4).

15.6 Preparing the machine for shipment

WARNING

Risk of accident due to unsecured machine parts

If the machine is not secured properly for transportation on a lorry or train, the parts may come loose unintentionally due to the airstream. This may result in serious accidents or damage to the machine.

- ▶ Carry out the following measures to secure moving machine parts.

15.6.1 Checklist for the transport of the machine

- ✓ All guards are properly closed and locked.
- ✓ Ladders for the tying system have been folded up, [see Page 82](#).
- ✓ The universal shaft is secured, [see Page 194](#).

- ✓ The hydraulic hoses are secured on the machine against dropping.
- ✓ Using a hoist with a minimum lifting capacity, the machine was lifted at the marked suspension points, [see Page 197](#). The minimum load capacity depends on the permissible total weight of the machine, [see Page 50](#).
- ✓ The machine is secured with suitable lashing material at the designated lashing points, [see Page 198](#).
- ✓ The machine was loaded on a lorry or train in the direction of travel.
- ✓ The operation unit or the terminal is stowed away in a safe and dry place.
- ✓ **For "SMV emblem" version:** The SMV emblem is covered or removed, [see Page 42](#).

15.6.2 Securing the front hood

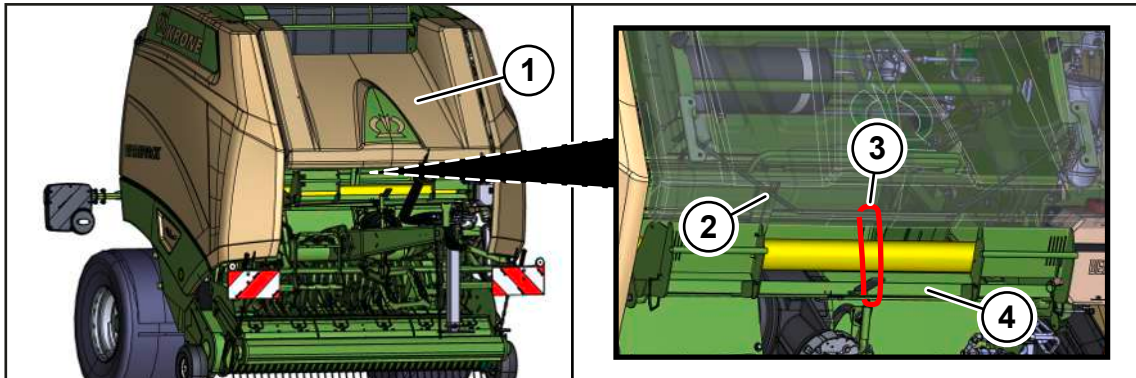

RPG001-244

- ✓ The front hood (1) is closed and locked into place.
- ▶ To secure the front hood (1), run a cable tie (3) around the locking bracket (2) and the strut (4) of the net holder.
- ▶ Tighten the cable tie (3).

15.6.3 Lifting the machine

 **WARNING**

Risk of injury due to raised machine

There is danger to persons when the machine drops or parts swing without control. Only qualified personnel are allowed to perform this work.

- ▶ Use only permitted hoists and slings with a sufficient load-bearing capacity. For the weights [see Page 50](#).
- ▶ Note the information on the suspension points provided.
- ▶ Make sure the lifting means are properly secured.
- ▶ Never stay under the suspended machine.
- ▶ If work has to be performed under the machine, securely support the machine, [see Page 29](#).

The machine is equipped with 3 suspension points.

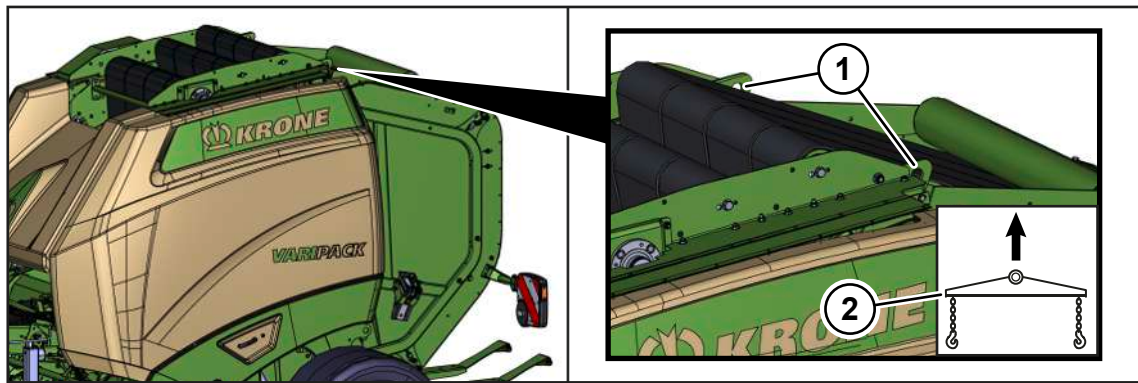

RPG000-216

There are 2 suspension points (1) at the top, next to the bale formation conveyor.

Ensure that a load beam (2) is used when the machine is lifted.

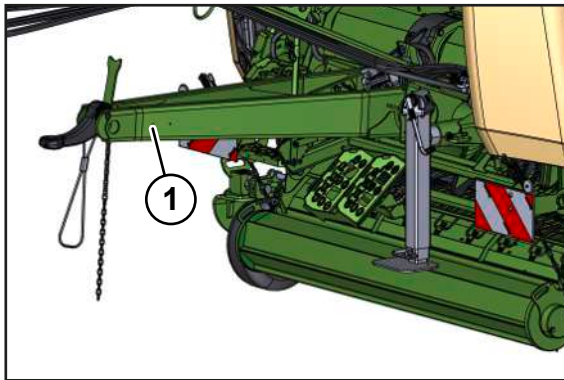

RPG000-217

1 suspension point is located in the front area of the drawbar (1).

To lift the machine, a hoist must be used which has a minimum load bearing capacity depending on the permitted total weight of the machine, see type plate on the machine, [see Page 45](#).

- ✓ The machine has been shut down and secured, [see Page 28](#).
- ▶ Close the tailgate.
- ▶ Lift the pick-up into the transport position, [see Page 84](#).
- ▶ Ensure that all safety devices are locked.
- ▶ Ensure that the universal shaft, hydraulic lines and cables have been secured.
- ▶ Attach the chains of the hoist to the suspension points on the machine.
- ▶ Ensure that the chain hooks have been correctly attached to the suspension points.
- ▶ Tension the chains so that the support jack is relieved.
- ▶ Move the support jack into transport position, [see Page 79](#).

15.6.4 Lashing the machine

WARNING

Danger to life caused by uncontrolled machine movement

If the machine is not properly lashed for transportation by vehicle, the machine may move in an uncontrolled manner and endanger people.

- ▶ Before transporting the machine, secure it properly to the designated lashing points using suitable lashing material.

The lashing points on the machine are marked by an information sign, *see Page 35*.

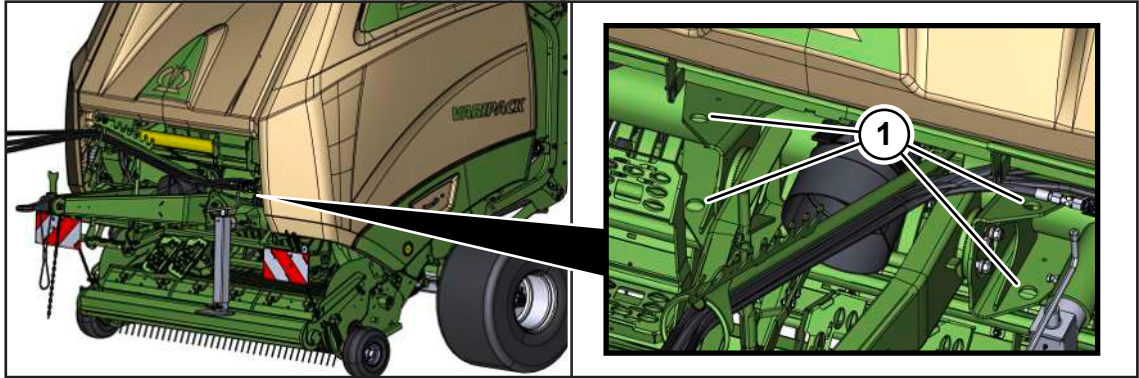

RPG000-219

1 2 lashing points at the front

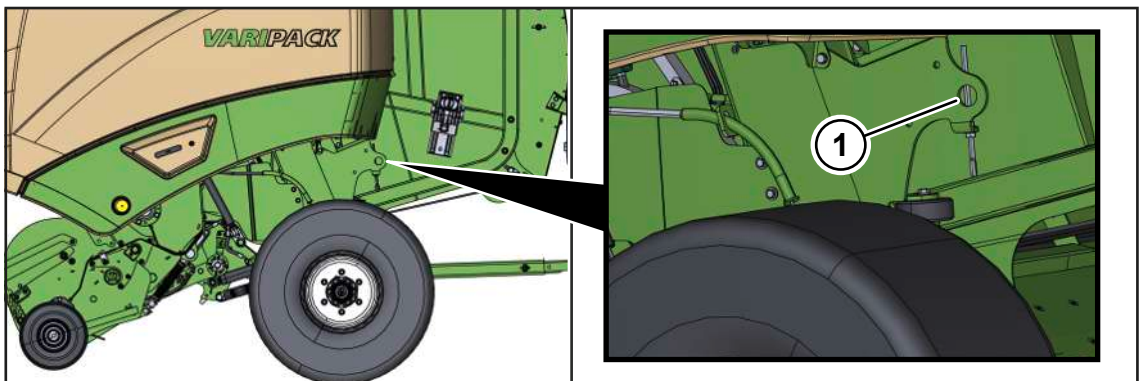

RPG000-220

1 2 lashing points at the rear (one on the left and one on the right machine side)

16 Settings

WARNING

Risk of injury due to non-observance of relevant safety notices

If the relevant safety notices are not observed, persons may get seriously injured or killed.

- ▶ To avoid accidents, the basic safety instructions must be read and observed, [see Page 16](#).

WARNING

Risk of injury due to non-observance of safety instructions

If the relevant safety routines are not observed, persons may be seriously injured or killed.

- ▶ The safety routines must be read and observed to avoid accidents, [see Page 28](#).

16.1 Setting the baling pressure

For version with "DS 100"

The baling pressure is set on the operation unit, [see Page 115](#).

For the remaining terminals

The baling pressure is set on the terminal via Menu 6 "Electronic baling pressure adjustment", [see Page 163](#).

16.2 Setting the bale diameter

For version with "Operation unit DS 100"

The bale diameter is set via the operation unit, [see Page 113](#).

For the remaining terminals

The bale diameter is set via the working screen on the terminal, [see Page 147](#).

16.3 Setting net overhang on the wrapping material brake

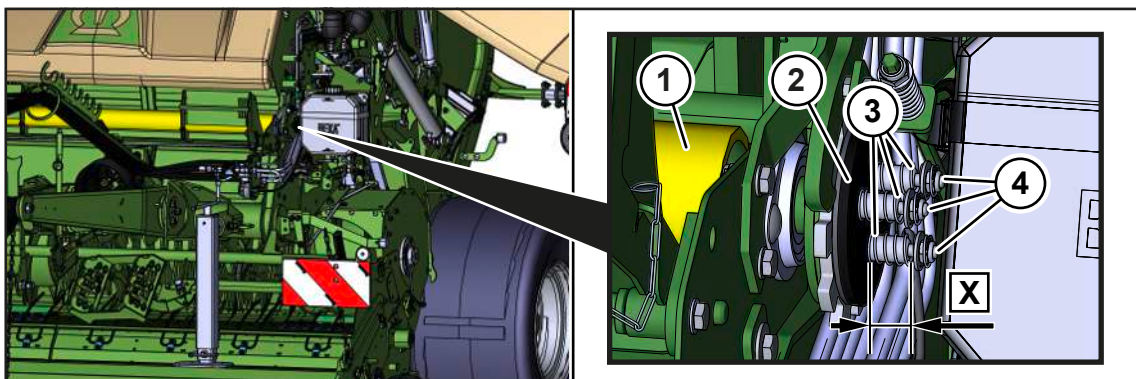

RPG000-163

The wrapping material brake (2) is located at the front on the left side of the machine.

The wrapping material brake (2) decelerates the yellow net prestretching roll (1) after the net has been cut off. It controls how much net protrudes between the rubber pads after each tying cycle under the spreading roll. The brake force is set using the 3 screws (4).

The net must protrude approx. **10 cm** between the rubber pads, [see Page 96](#).

Default dimension of the 3 springs (3) set by KRONE: **X=24 mm**

- ✓ The machine has been shut down and secured, [see Page 28](#).
- ✓ The left side hood is open.
- ▶ Check the net overhang between the rubber .

If the net overhang is too long, increase the brake force:

- ▶ Reduce the dimension X.

If the net overhang is too short, reduce the brake force:

- ▶ Increase the dimension X.

16.4 Setting rubber cloth on the net wrapping

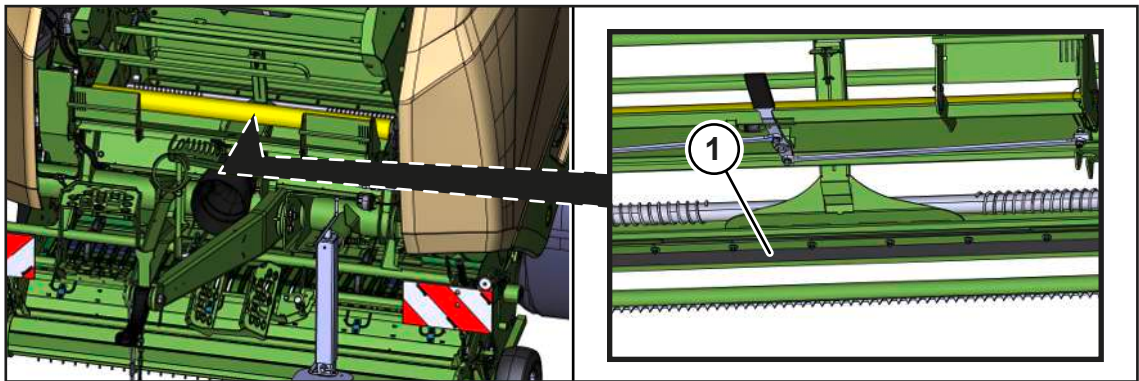

RPG000-200

If the rubber cloth (1) is worn and is no longer 2-3 cm at full width on the feed roller, it can be set.

- ✓ The machine has been shut down and secured, [see Page 28](#).
- ▶ Loosen the screw connections and push the bale cloth in the oblong holes until it is 2-3 cm on the feed roller.
- ▶ If this setting is not adequate, replace the bale cloth (1).

16.5 Adjusting the twine tension at the twine box

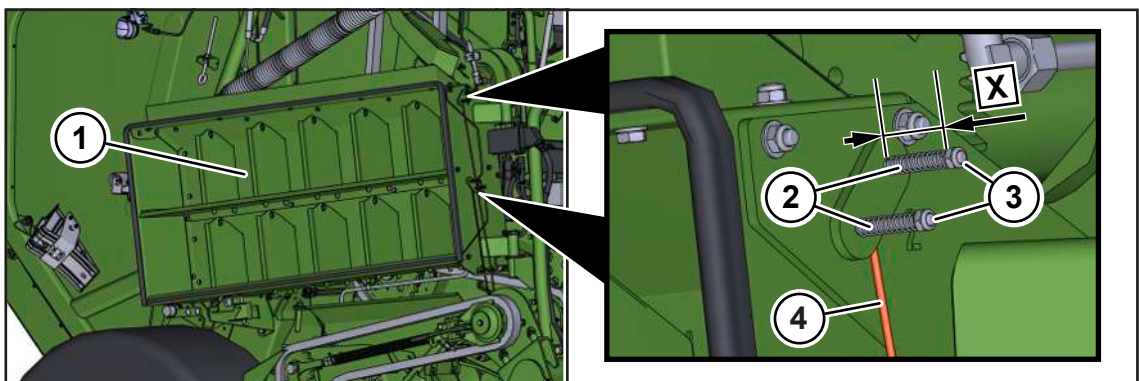

RP001-033

The twine tension at the outlet eyelets of the twine box (1) is used to adjust the tightness of the tying twine (4) as it runs through the machine. This can change as tying twines and working conditions change. It should be adjusted as loosely as possible so that the tying twine (4) can be pulled as easily as possible when tying is started. All the same, the tying twine (4) should be taut inside the machine so that vibrations or the like will not pull it out of the machine.

At the factory, the springs (2) are adjusted to a distance of $X=40$ mm.

- ✓ The machine has been shut down and secured, [see Page 28](#).
- ✓ The right-hand side hood is open.

Use the same setting for all 4 screws on the top and bottom twine (4):

- ▶ To increase the twine tension, use the nut (3) to reduce the distance X.
- ▶ To reduce the twine tension, use the nut (3) to increase the distance X.

16.6 Adjusting the twine tension at the twine brake

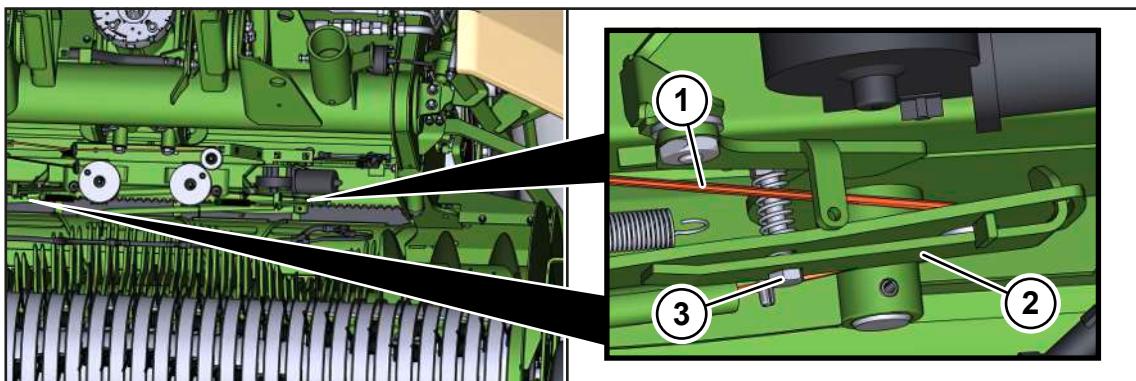

RP001-036

The twine tension on the twine brake (2) is used to adjust the tightness at which the twine (1) is guided to the round bale. This permits the twine to be distributed consistently tight on the round bale during the tying cycle. This twine tension can change as tying twine and working conditions change.

There is one twine brake (2) on the top tying twine on the right side and one twine brake on the bottom tying twine on the left side, which must be adjusted in the same way.

- ✓ The machine has been shut down and secured, [see Page 28](#).
- ✓ The twine is inserted, [see Page 101](#).
- ▶ To increase the twine tension, use the nut (3) to increase the tightness of the twine brake (2).
- ▶ To reduce the twine tension, loosen the twine brake (2) at the nut (3).

16.7 Checking/adjusting blades at the twine tying system

WARNING

Risk of injury on the sharp blade of the twine tying system

There is a risk of injury to fingers and hands when adjusting the blade on the twine tying system.

- ▶ Wear protective gloves when you adjust the blade on the twine tying system.
- ▶ Be particularly careful when you work on the twine tying system in the vicinity of the blade.

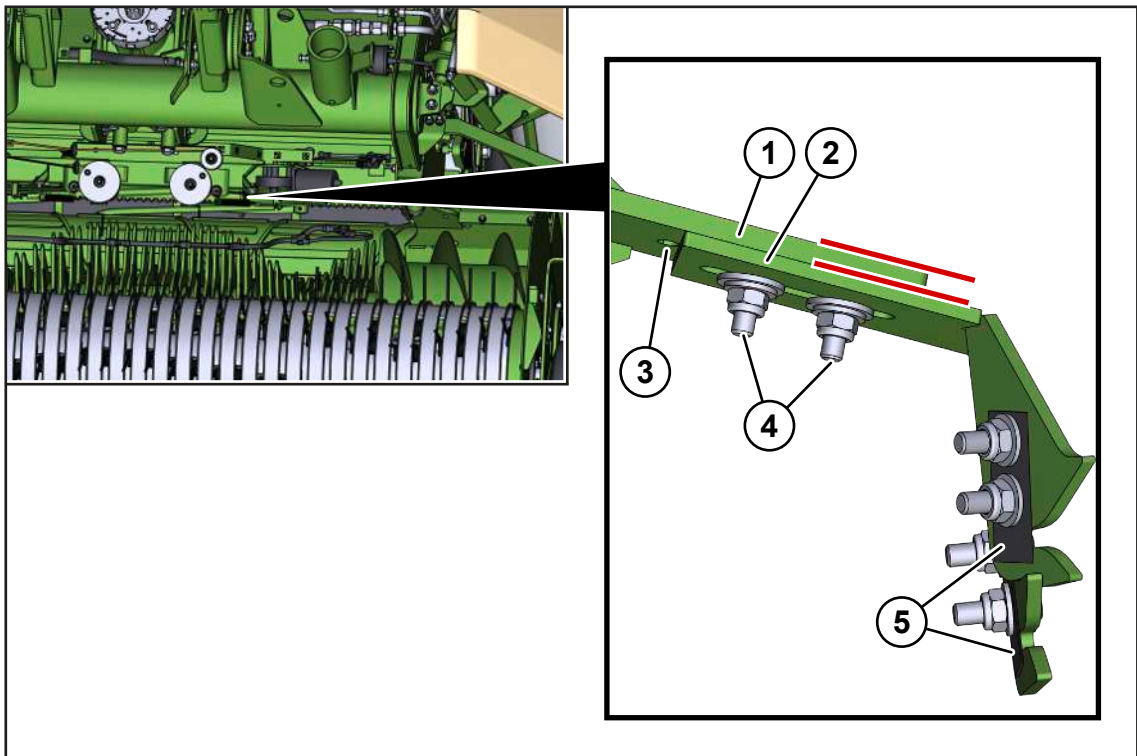

RP001-037

Two blades (5) are installed on the blade support (2).

- ▶ Check to ensure that the edges of the blade support (2) and the blade arm (1) are parallel to each other.
- ▶ Check also to ensure that the blade support (2) is pushed up to the borehole (3).
- ▶ If this is not the case, loosen the screw connections (4) and move the blade support (2).

16.8 Setting oil quantities for the central chain lubrication unit

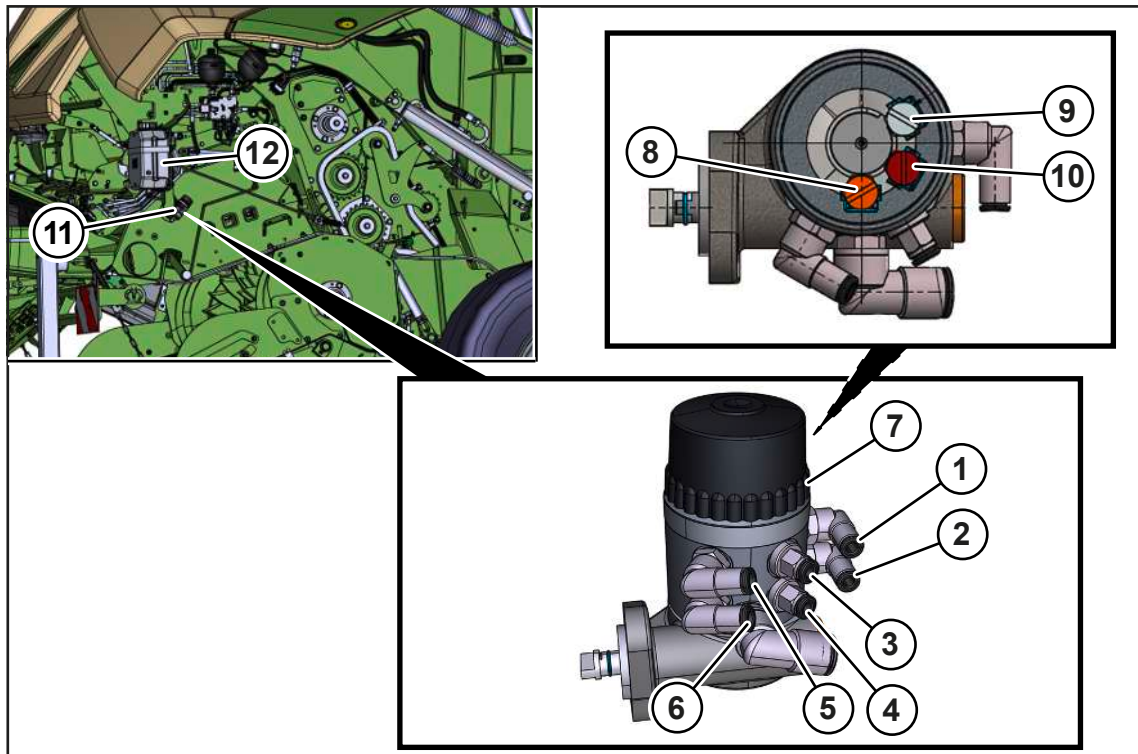

RPG000-135

The central chain lubrication system is located on the left side of the machine behind the side hood.

With each revolution of the drive shaft, the oil pump (11) pumps oil from the tank (12) through the outlets (1), (2), (3), (4), (5), and (6) to the oil brushes on the drive chains.

To service the central chain lubrication system, [see Page 237](#).

Setting oil volumes

The oil quantities for the individual brushes of the central chain lubrication system can be increased or reduced at the oil pump (11).

To set the oil quantities, the setting screws (8), (9) or (10) are turned. One complete turn corresponds to a quarter of the maximum oil quantity.

For an overview of the oil brushes on the machine, [see Page 238](#).

✓ The machine has been shut down and secured, [see Page 28](#).

- ▶ Unscrew the cover (7) on the oil pump.
- ▶ To increase the oil quantity, turn the required setting screw (8), (9) or (10) clockwise.
- ▶ To reduce the oil quantity, turn the required setting screw (8), (9) or (10) anti-clockwise.

The setting screws are assigned as follows:

Pos.	Oil lubrication for	setting screw
(1)	Drive no. 1 – baling unit	(8) white
(2)		
(3)	Drive no. 2 – rotor	(9) red
(4)		
(5)	Drive no. 3 – feed roller and starter roller	(10) orange

Pos.	Oil lubrication for	setting screw
(6)	Drive no. 3 – feed roller and starter roller	(10) orange

16.9 Setting the cutting length

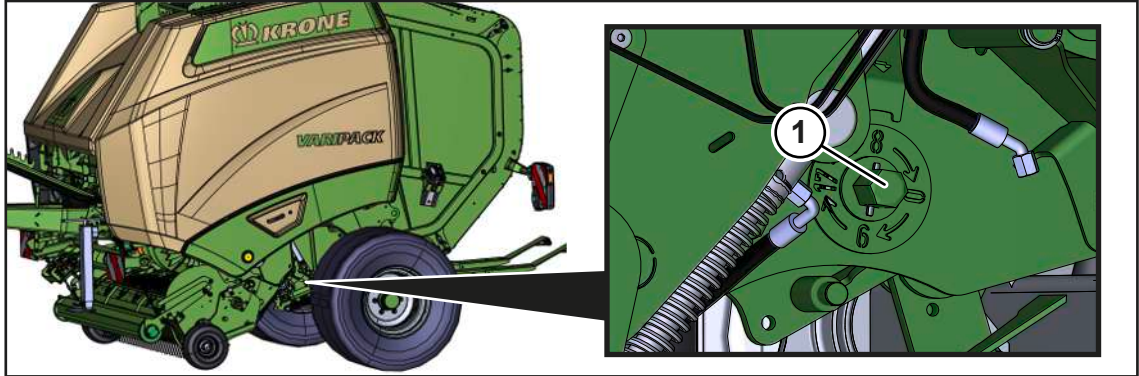

RPG000-155

The cutting length is determined by the number of blades used. For this purpose, the blade groups are swivelled in or out using the blade control shaft (1).

Cutting length	Number of blades	Blade group A	Blade group B
-	0	off	off
128 mm	8	off	on
128 mm	9	on	off
64 mm	17	on	on

- ▶ Swivel the required blade groups in or out, [see Page 91](#).

16.10 Setting the bale ejector

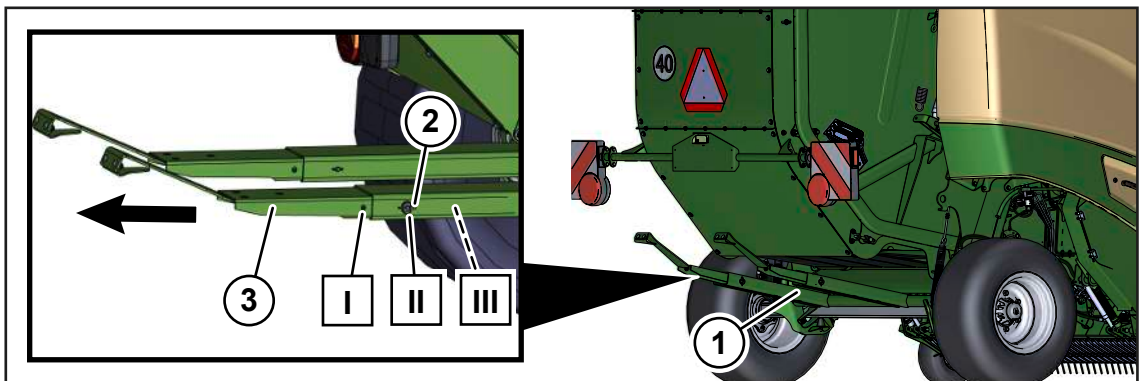

RPG000-167

The bale ejector (1) can be set in 3 positions (Position I, II and III).

Position	Explanation
I	Round bales up to 165 cm
II	Round bales up to 190 cm
III	For soft ground

- ✓ The machine has been shut down and secured, [see Page 28](#).

Make the following setting on both tips of the bale ejector (1) in the same way:

- ▶ Dismount the linch pin (2) and the bolt.
- ▶ Pull out the extension (3) in the direction of the arrow until the required position (I), (II) or (III) has been reached.
- ▶ Mount the bolt and the linch pin (2). Ensure that the linch pin is mounted from the outside.

17 Service & maintenance

 WARNING
<p>Risk of injury due to non-observance of relevant safety notices</p> <p>If the relevant safety notices are not observed, persons may get seriously injured or killed.</p> <ul style="list-style-type: none"> ▶ To avoid accidents, the basic safety instructions must be read and observed, see Page 16.

 WARNING
<p>Risk of injury due to non-observance of safety instructions</p> <p>If the relevant safety routines are not observed, persons may be seriously injured or killed.</p> <ul style="list-style-type: none"> ▶ The safety routines must be read and observed to avoid accidents, see Page 28.

NOTICE
<p>Damage to the machine due to incorrectly performed or unfinished maintenance work</p> <p>There is a risk of machine damage if maintenance work is not carried out by qualified personnel. A qualified specialist workshop has the required technical knowledge, qualification and tools to perform the required work on the machine properly. This applies in particular to safety-relevant work.</p> <ul style="list-style-type: none"> ▶ Have specially designated work performed by a qualified service centre only.

17.1 Observe the service record booklet

A service record booklet is enclosed with the machine. The service record booklet is absolutely essential as proof of regular maintenance in the event of any material defect claims under warranty and in particular as part of a warranty extension.

- ▶ Have the completed maintenance work confirmed by the KRONE service partner in the supplied service record booklet.

17.2 Maintenance table

17.2.1 Maintenance – Before the season

The manual for service technicians contains other maintenance items which must also be carried out. These may be carried out only by authorised qualified personnel.

Checking oil level	
Main gearbox	see Page 220
Chain lubrication unit	see Page 237
Components	
Adjust drive chains	see Page 234
Tighten screws/nuts on the machine	see Page 215
Retightening wheel nuts	see Page 219
Check tyre pressure	see Page 218
Check the fire extinguishers	see Page 228

Components	
Cleaning bushing and drawbar eye	see Page 223
Clean the filter on the central chain lubrication system	see Page 237
Drain condensation water out of the compressed air tanks of the compressed air brake	see Page 240
Checking and adjusting the cleaning rollers	see Page 225
Lubricate the machine according to the lubrication chart	see Page 210
Actuate tying cycle and check functions	see Page 79
Check hydraulic hoses	see Page 242
Check the electrical connection cables and, if necessary, have them repaired or changed by a KRONE service partner	
Removing corrosion from net support / holder	see Page 228

17.2.2 Maintenance – After the season

Components	
Clean the machine	see Page 221
Lubricate the machine according to the lubrication chart	see Page 210
Lubricate the universal shaft	see Page 214
Grease the threads of the setting screws	
Drain condensation water out of the compressed air tanks of the compressed air brake	see Page 240
Cleaning drive chains	see Page 223
Grease the uncoated piston rods of all hydraulic cylinders and insert as far as possible	
Lightly coat with oil all those lever joints and bearing positions which cannot be lubricated	
Touch up damaged paint and preserve uncoated areas with rust protection agent	
Check that all moveable components move freely. If required, dismount, clean, grease and remount.	
Park the machine in a weatherproof and dry location which is not in close proximity to corrosive substances	
Protect the tyres against external influences such as oil, grease or direct sunlight	
Calibrate sensor B09 "Filling indicator" in menu 15-1 "Sensor test" on the terminal	see Page 183

17.2.3 Maintenance – once after 10 hours

The manual for service technicians contains other maintenance items which must also be carried out. These may be carried out only by authorised qualified personnel.

Components	
Retightening wheel nuts	see Page 219
Tighten the screw connections on the drawbar	see Page 224
Check tyre pressure	see Page 218
Check the hydraulic hoses for leaks and, if necessary, have them replaced by a KRONE service partner.	see Page 242
Cleaning bushing and drawbar eye	see Page 223
Change/replace blades	see Page 229

17.2.4 Maintenance – once after 50 hours

The manual for service technicians contains other maintenance items which must also be carried out. These may be carried out only by authorised qualified personnel.

Components	
Calibrate sensor B09 "Filling indicator" in menu 15-1 "Sensor test" on the terminal	see Page 183

17.2.5 Maintenance – Once after 500 round bales

Components	
Checking and adjusting the cleaning rollers	see Page 225

17.2.6 Maintenance – every 10 hours, at least daily

Checking oil level	
Main gearbox	see Page 220

Components	
Clean the machine	see Page 221
Check the fire extinguishers	see Page 228
Check function of the brake system	
Cleaning bushing and drawbar eye	see Page 223

17.2.7 Maintenance – every 50 hours

Components	
Tighten screws/nuts on the machine	see Page 215
Tighten the screw connections on the drawbar	see Page 224
Retightening wheel nuts	see Page 219
Check tyre pressure	see Page 218
Drain condensation water out of the compressed air tanks of the compressed air brake	see Page 240

17.2.8 Maintenance – Every 250 hours

Components	
Check the fire extinguishers	see Page 228

17.2.9 Maintenance – Every 500 hours

The manual for service technicians contains other maintenance items which must also be carried out. These may be carried out only by authorised qualified personnel.

17.2.10 Maintenance – Every 1,000 round bales

The manual for service technicians contains other maintenance items which must also be carried out. These may be carried out only by authorised qualified personnel.

17.2.11 Maintenance – Every 2 years

The manual for service technicians contains other maintenance items which must also be carried out. These may be carried out only by authorised qualified personnel.

17.3 Lubrication chart

<i>NOTICE</i>
<p>Damage to bearing points</p> <p>When using lubricating greases not approved and when mixing different lubricating greases, the lubricated parts may be damaged.</p> <ul style="list-style-type: none"> ▶ Only use approved lubricating greases, see Page 53. ▶ Do not use graphite-containing lubricating greases. ▶ Do not mix different lubricating greases.

<i>NOTICE</i>
<p>Environmental damage caused by consumables</p> <p>If consumables are not stored and disposed of properly, they may escape into the environment. As a result, the environment will be damaged, even by small quantities.</p> <ul style="list-style-type: none"> ▶ Store the consumables in suitable containers according to the statutory provisions. ▶ Dispose of used consumables according to statutory provisions.

The information on maintenance intervals is based on average load of the machine. In case of an increased load and under extreme working conditions, the time periods must be reduced. The types of lubrication are marked by means of icons in the lubrication chart, refer to table.

Type of lubrication	Lubricant	Comment
Grease 	Multi-purpose grease	<ul style="list-style-type: none"> ▶ Apply two strokes of lubricating grease from the grease gun per grease nipple. ▶ Remove excess lubricating grease at the grease nipple.

Left side of machine

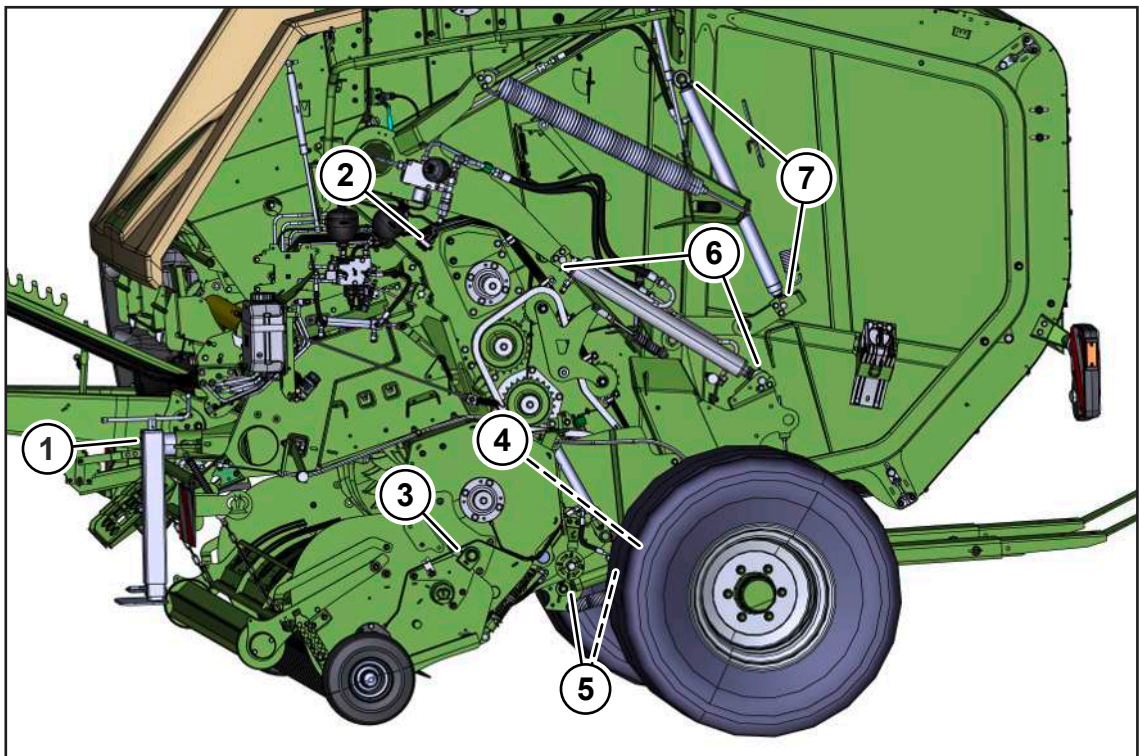

RPG000-169

Every 20 operating hours

(2)

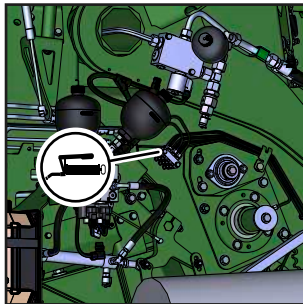

(3)

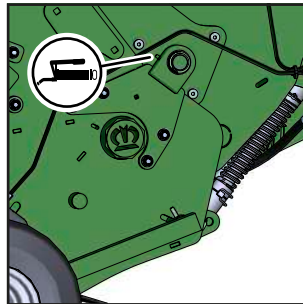

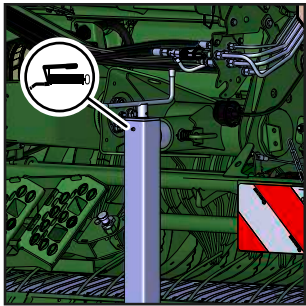
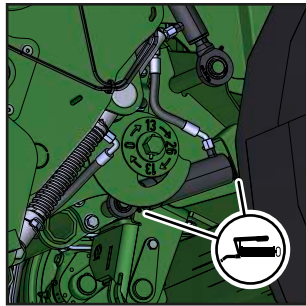
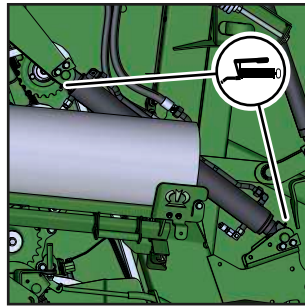
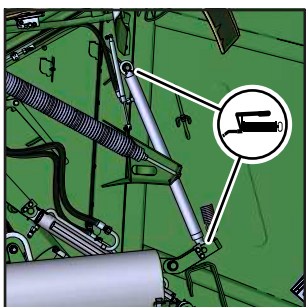
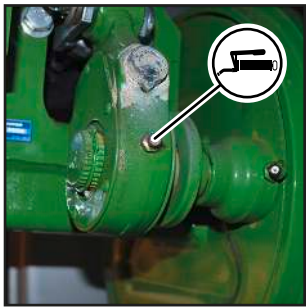
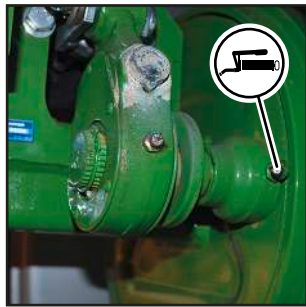
Every 50 operating hours		
<p>(1)</p> 	<p>(5)</p> 	<p>(6)</p> 
<p>(7)</p> 		
Every 500 operating hours		
<p>(4)</p> 	<p>(4)</p> 	
	<p>Use a different lubricating grease for this lubrication point, see Page 53.</p>	

Right side of machine

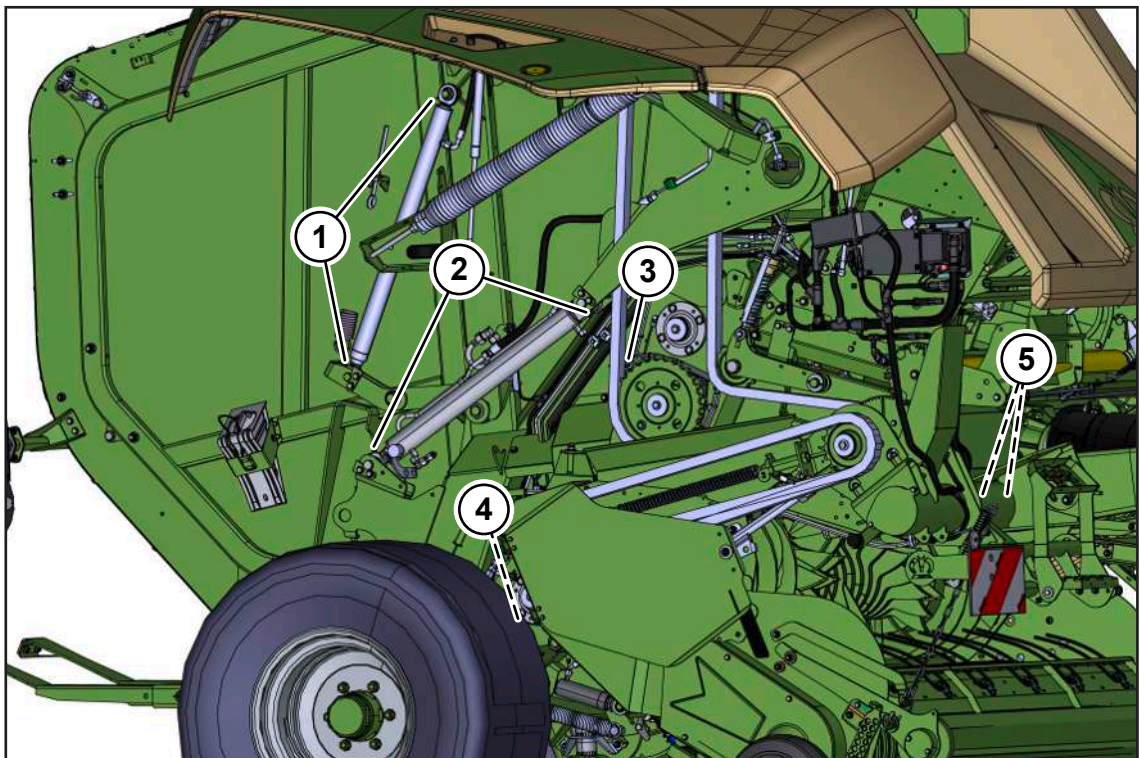

RPG000-170

Every 20 operating hours

(3)

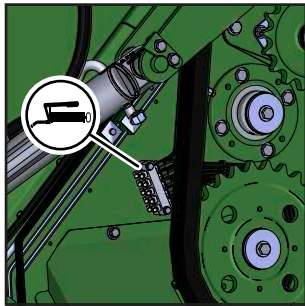

Every 50 operating hours

(1)

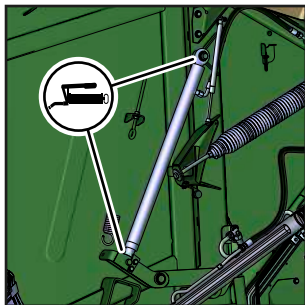

(2)

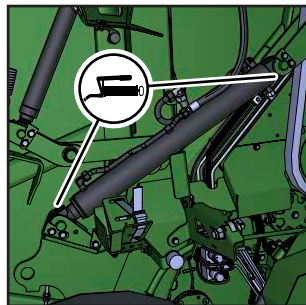

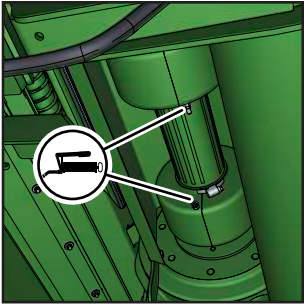
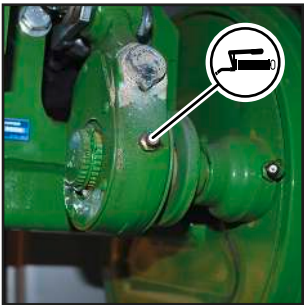
Every 100 operating hours		
(5)		
Every 500 operating hours		
(4)		(4)
		Use a different lubricating grease for this lubrication point, see Page 53 .

17.4 Lubricating the universal shaft

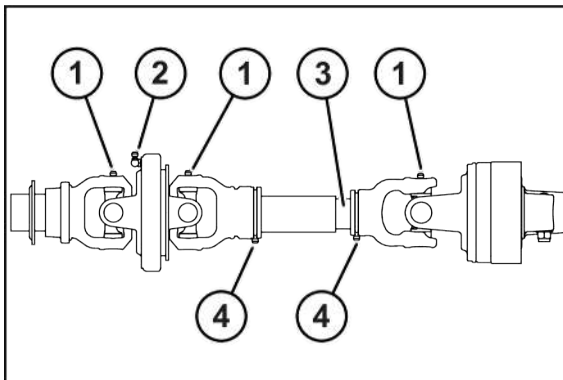

RP000-176

- ✓ The machine has been shut down and secured, [see Page 28](#).
- ▶ Observe operating instructions of the universal shaft manufacturer.
- ▶ Clean the universal shaft.
- ▶ Lubricate the universal shaft with multi-purpose grease at the intervals indicated in the table below.

For a list of the lubricating greases to be used, [see Page 52](#).

The following table provides information about the lubricant quantity and the lubrication interval per lubrication point.

Pos.	Lubricant quantity	Lubrication interval
(1)	18 g	50 hours
(2)	30 g	
(3)	20 g	
(4)	6 g	

17.5 Tightening torques

Deviating tightening torques

All screw connections must in general be tightened with the listed tightening torques following. Deviations from the tables are marked accordingly.

Metric thread screws with control thread

INFO

The table does not apply to countersunk screws with hexagon socket in case the countersunk screw is tightened via hexagon socket.

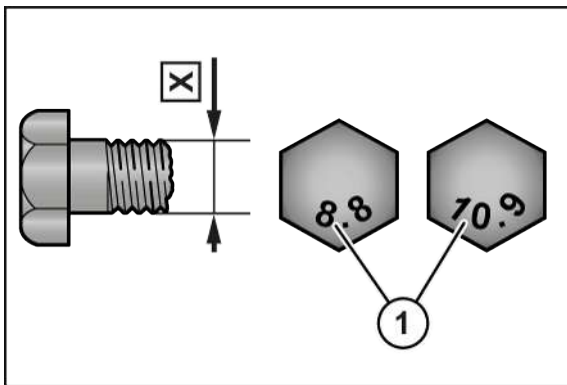

DV000-001

X Thread size

1 Strength class on screw head

X	Strength class			
	5.6	8.8	10.9	12.9
	Tightening torque (Nm)			
M4		3.0	4.4	5.1
M5		5.9	8.7	10
M6		10	15	18
M8		25	36	43
M10	29	49	72	84
M12	42	85	125	145
M14		135	200	235
M16		210	310	365
M20		425	610	710
M22		571	832	972

X	Strength class			
	5.6	8.8	10.9	12.9
	Tightening torque (Nm)			
M24		730	1,050	1,220
M27		1,100	1,550	1,800
M30		1,450	2,100	2,450

Metric thread screws with fine thread

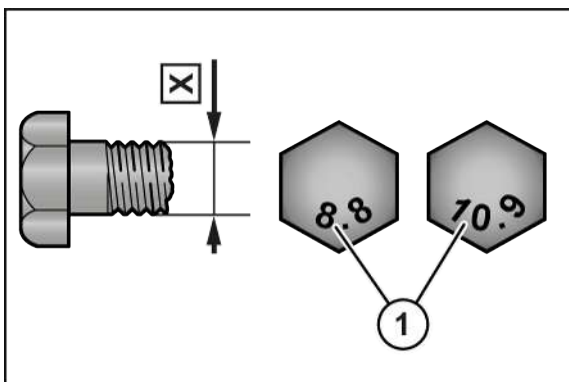

DV000-001

X Thread size

1 Strength class on screw head

X	Strength class			
	5.6	8.8	10.9	12.9
	Tightening torque (Nm)			
M12 x 1.5		88	130	152
M14 x 1.5		145	213	249
M16 x 1.5		222	327	382
M18 x 1.5		368	525	614
M20 x 1.5		465	662	775
M24 x 2		787	1,121	1,312
M27 x 2		1,148	1,635	1,914
M30 x 1.5		800	2,100	2,650

Metric thread screws with countersunk head and hexagon socket

INFO

The table applies only to countersunk screws with hexagon socket and metric thread tightened via hexagon socket.

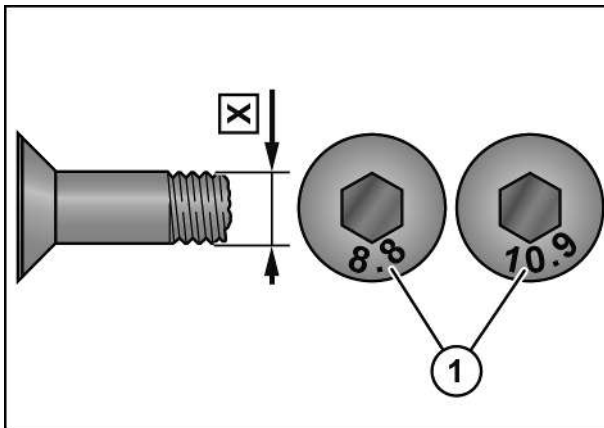

DV000-000

X Thread size

1 Strength class on screw head

X	Strength class			
	5.6	8.8	10.9	12.9
	Tightening torque (Nm)			
M4		2.5	3.5	4.1
M5		4.7	7	8
M6		8	12	15
M8		20	29	35
M10	23	39	58	67
M12	34	68	100	116
M14		108	160	188
M16		168	248	292
M20		340	488	568

Locking screws on the gearboxes

INFO

The tightening torques only apply to assembly of locking screws, viewing glasses, ventilation and breather filters and bleed valves in gearboxes with cast housings or aluminium or steel housings. The term "locking screw" includes the drain plug, the inspection screw as well as the ventilation and breather filters.

This table applies only to locking screws with external hexagon in connection with copper seal ring and for bleed valves made of brass with shaped seal ring.

Thread	Locking screw and sight glass with copper ring ¹		Bleed valve made of brass	
	Ventilation/breather filter made of steel		Ventilation/breather filter made of brass	
	Steel and cast	Aluminium	Steel and cast	Aluminium
Maximum tightening torque (Nm) (±10%)				
M10x1			8	
M12x1.5			14	
G1/4"			14	
M14x1.5			16	

Thread	Locking screw and sight glass with copper ring ¹		Bleed valve made of brass	
	Ventilation/breather filter made of steel		Ventilation/breather filter made of brass	
	Steel and cast	Aluminium	Steel and cast	Aluminium
Maximum tightening torque (Nm) (±10%)				
M16x1.5	45	40	24	24
M18x1.5	50	45	30	30
M20x1.5			32	
G1/2"			32	
M22x1.5			35	
M24x1.5			60	
G3/4"			60	
M33x2			80	
G1"			80	
M42x1.5			100	
G1 1/4"			100	

¹ Always replace copper rings.

17.6 Checking/maintaining tyres

✓ The machine has been shut down and secured, [see Page 28](#).

Inspect the tyres visually

- ▶ Visually inspect tyres for cuts or breaks.
- ➔ If there are cuts or breaks in the tyres, have the tyres repaired or replaced by a KRONE service partner.

Maintenance intervals for visual inspection of the tyres, [see Page 207](#).

Checking/adapting the tyre pressure

- ▶ Check the tyre pressure, [see Page 51](#).
- ➔ If the tyre pressure is too high, deflate air.
- ➔ If the tyre pressure is too low, increase the tyre pressure.

Check the maintenance intervals for tyre pressure, [see Page 207](#).

Retighten wheel nuts

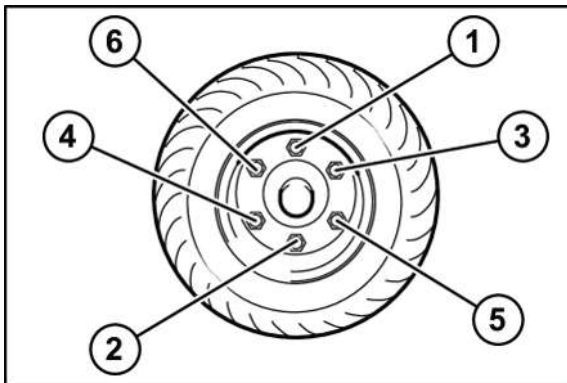

DVG000-002

- ▶ Retighten the wheel nuts crosswise (as shown) with a torque wrench, tightening torque [see Page 219](#).

Maintenance intervals, [see Page 207](#).

Tightening torques for "BPW axle" version

Thread	Key size	Amount of bolts per hub	Maximum tightening torque	
			black	galvanised
Bolt centring				
M18x1.5	24 mm	6 units	270 Nm	250 ... 290 Nm
M20x1.5	27 mm	8 units	380 Nm	360 ... 400 Nm
M22x1.5	32 mm	8/10 units	510 Nm	485 ... 535 Nm
Hub centring				
M22x1.5	32 mm	10 units	630 Nm	600 ... 660 Nm

Tightening torques for "ADR/Colaert axle" version

Thread	Key size	Amount of bolts per hub	Maximum tightening torque	
			black	galvanised
Bolt centring				
M12x1.5	17 mm	4/5 units	—	90 ... 100 Nm
M14x1.5	19 mm	5 units	—	130 ... 140 Nm
M18x1.5	24 mm	6 units	—	270 ... 290 Nm
M20x1.5	30 mm	8 units	—	350 ... 380 Nm
M22x1.5	30 mm	8/10 units	—	450 ... 510 Nm
Hub centring				
M18x1.5	27 mm	6 units	—	270 ... 290 Nm
M22x1.5	32 mm	8/10 units	—	450 ... 510 Nm
M24x1.5	36 mm	10 units	—	550 ... 610 Nm

17.7 Servicing the main gearbox

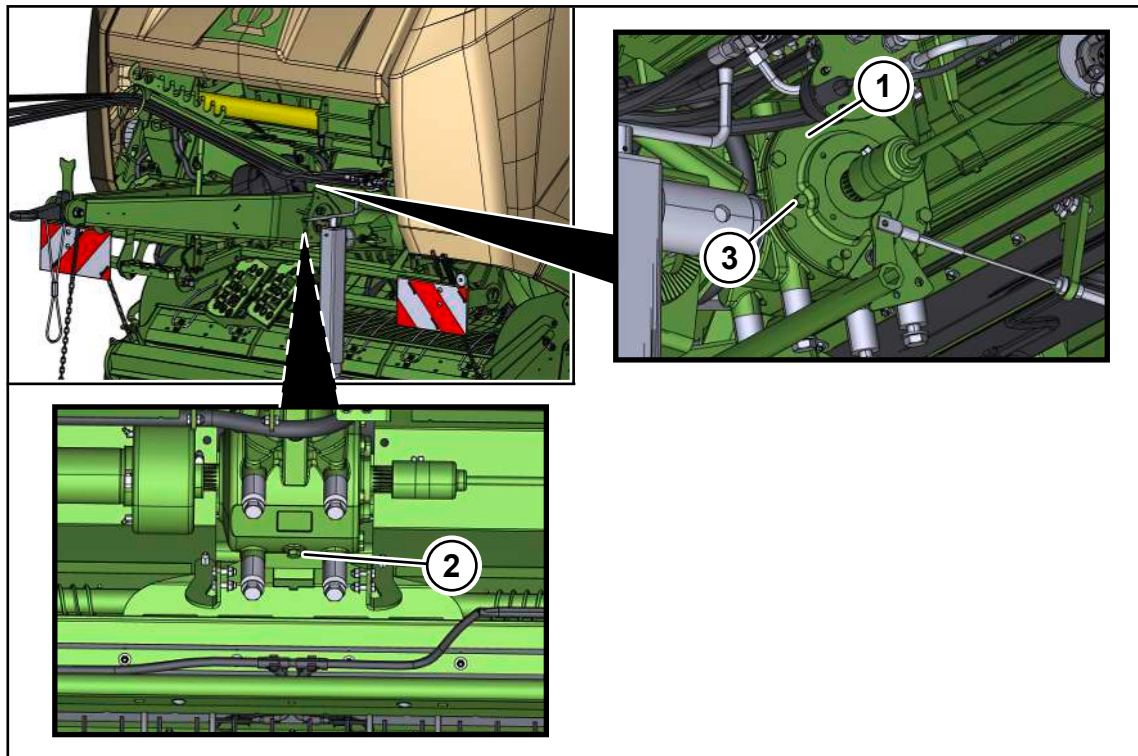

RPG000-089

The main gearbox (1) is located behind the drawbar in the front area of the machine. The locking screw (2) for draining the oil is located on the underside of the main gearbox (1). The locking screw of the inspection and filling hole (3) is located on the main gearbox (1).

Maintenance intervals: [see Page 207](#)

Amount and type specifications of the oil: [see Page 52](#)

- ✓ The machine is horizontal on stable and level ground.
- ✓ The machine has been shut down and secured, [see Page 28](#).
- ✓ The drawbar height has been set correctly, [see Page 55](#).

Checking oil level

NOTE! Risk of machine damage due to improperly performed oil level check, oil and filter element change! Follow the safety routine "Oil level check. Changing oil and filter elements safely", [see Page 29](#).

- ▶ Remove the locking screw from the inspection and filling hole (3).
 - ⇒ The oil must reach the inspection and filling hole (3).

If the oil reaches the inspection and filling hole (3):

- ▶ Screw the locking screw into the inspection and filling hole (3), tightening torque [see Page 217](#).

If the oil does not reach the inspection and filling hole (3):

- ▶ Top up with fresh oil via the inspection and filling hole (3) up to the inspection and filling hole (3).
- ▶ Screw the locking screw into the inspection and filling hole (3), tightening torque [see Page 217](#).

17.8 Cleaning the machine

 **WARNING**

Eye damage caused by flying dirt particles!

When cleaning the machine with compressed air or with high-pressure cleaner, the dirt particles are slung away at high speed. The dirt particles may hit the eyes and hurt them.

- ▶ Keep persons away from working range.
- ▶ When performing cleaning work with compressed air or with high-pressure cleaner, wear suitable working clothes (for example eye protection).

 **WARNING**

Risk of injury if the stop cock of the tailgate is opened

When working on or underneath the opened tailgate or inside the bale chamber, the tailgate may drop down in an uncontrolled manner if the stop cock is opened. As a result, people may be seriously injured or killed.

- ▶ Always close the stop cock when carrying out work with the tailgate open.

NOTICE

Machine damaged by water from a high-pressure cleaner

Bearings and electric or electronic components can be damaged if you aim the water jet of a high-pressure cleaner directly at them during cleaning.

- ▶ Do not direct the water jet of a high-pressure cleaner at bearings, electrical/electronic components and safety signs.
- ▶ Replace missing, damaged and unrecognisable safety signs.

 **WARNING**

Risk of injury if the stop cock of the tailgate is opened

When working on or underneath the opened tailgate or inside the bale chamber, the tailgate may drop down in an uncontrolled manner if the stop cock is opened. As a result, people may be seriously injured or killed.

- ▶ Always close the stop cock when carrying out work with the tailgate open.

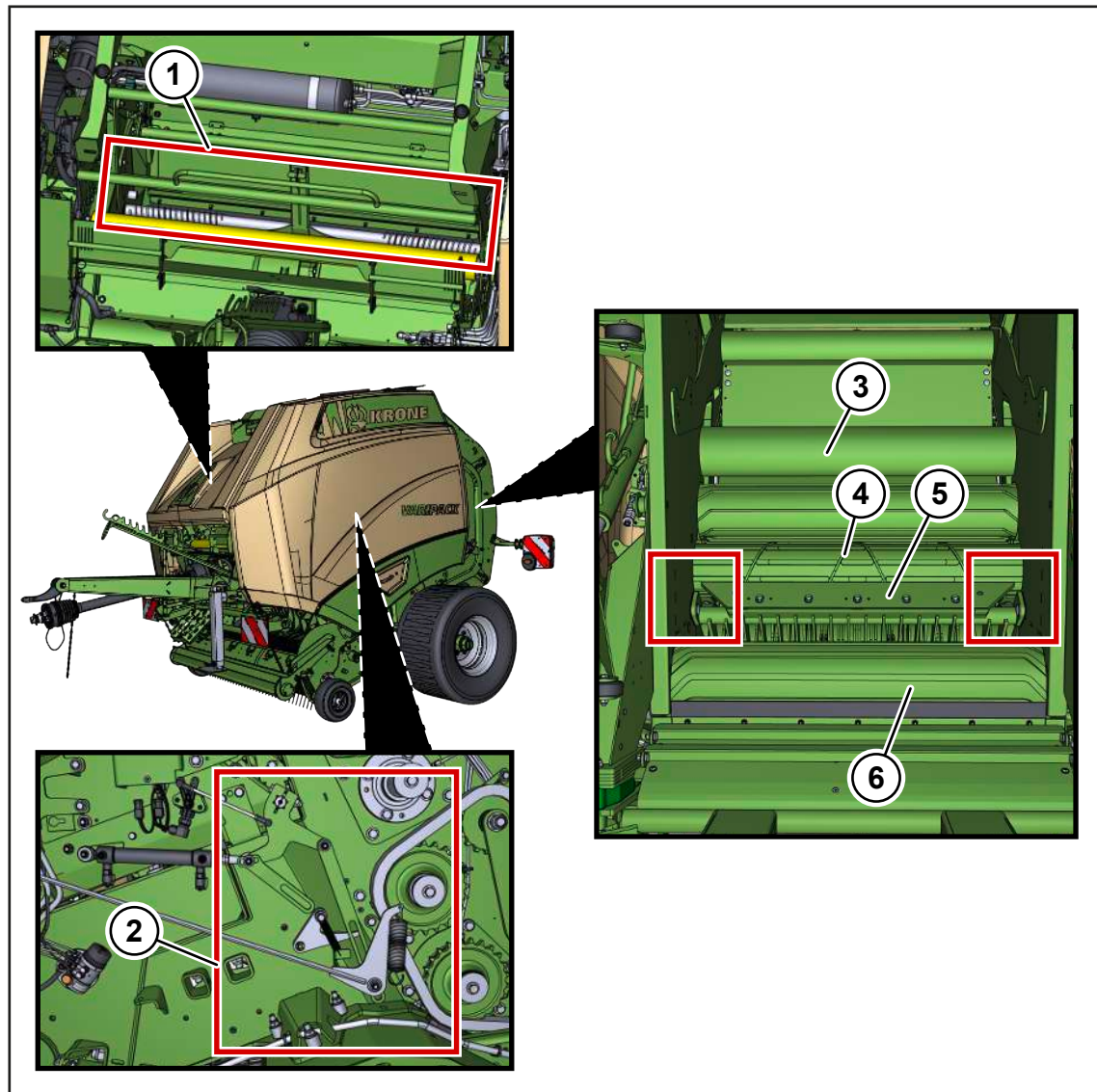

RPG000-274

- ✓ The tailgate is open and secured against lowering with the stop cock, [see Page 105](#).
- ✓ The machine has been shut down and secured, [see Page 28](#).
- ▶ After each use, clean the following areas on the machine, preferably with compressed air:
 - the area around the tying at the front (1) and on the left side of the machine (2)
 - the area around the drive roller (3)
 - **for the "cleaning rollers" version**: the area between the cleaning roller and the drive roller (3)
 - the area between the scraper (5) and the compression roller (4) – pay particular attention to the side areas.
 - the area around the starter roller (6)
 - **for the "cleaning rollers" version**: the area between the cleaning roller and the deflection roller at the bottom of the tailgate
 - the deflection rollers of the baling belts
- ▶ Also after each use, clean all moving parts on the brake linkage and brake lever with compressed air, e.g. piston rod, brake lever and slack adjuster. This can prevent mechanical blockages.
- ▶ Remove crop build-up from the drive chains using compressed air.
- ▶ Ensure that the drive chains are sufficiently wetted with engine oil after cleaning.
- ▶ If required, repeat the cleaning several times a day.

- ▶ After the machine has been cleaned with water, lubricate all manually lubricated lubrication points, [see Page 210](#).

17.9 Clean the bushing and the drawbar eye

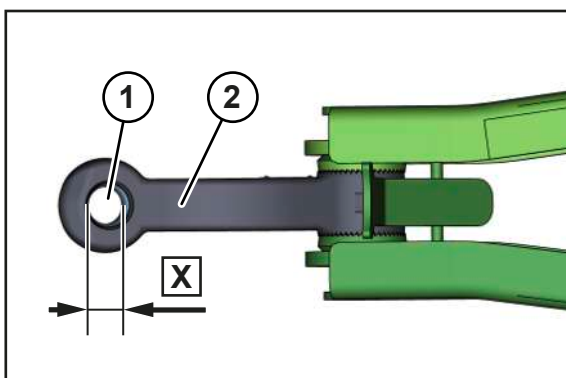

RPG000-189

The drawbar eye must always be coupled horizontally in the towing hitch. The wear limit of the socket (1) in the drawbar eye (2) is **X=43 mm**. If the dimension X is exceeded, the drawbar eye (1) must be replaced by a KRONE service partner.

- ▶ To minimize wear, clean the bushing (1) and the drawbar eye (2) several times a day and coat with grease.

17.10 Cleaning drive chains

At the end of the season the machine drive chains must be cleaned.

- ✓ The machine has been shut down and secured, [see Page 28](#).
- ▶ Clean the drive chains with compressed air.
- ▶ Wet the cleaned drive chains with engine oil.
- ▶ Start up the machine to distribute the engine oil on all contact surfaces.

The drive chains must always be adequately wetted with engine oil.

During operation, this is done by the chain lubrication unit, [see Page 237](#).

- ▶ Shut down and safeguard the machine, [see Page 28](#).
- ▶ Check the drive chains and sprocket wheels for wear.
- ▶ Check that the drive chains are centred on the sprocket wheels.
- ▶ Check that the drive chains have been properly adjusted, [see Page 234](#).

17.11 Relieving baling belts

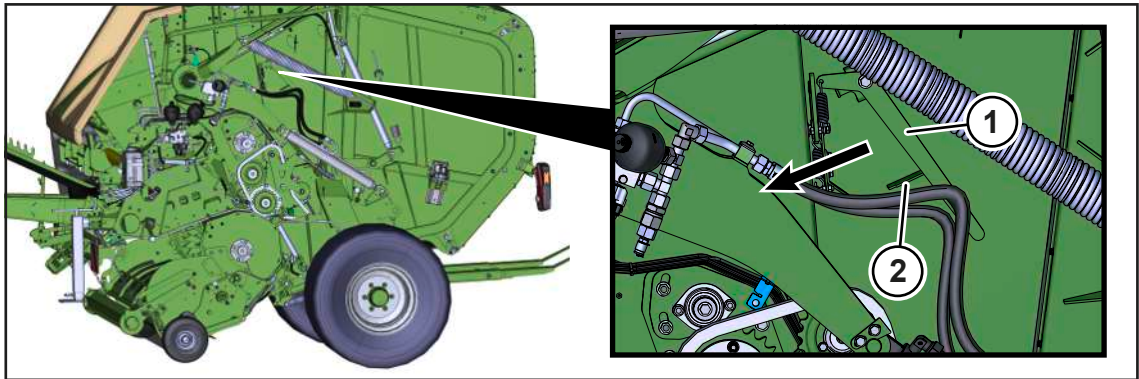

RPG000-147

Using the lever (1), you can move the tensioning rocker arms to a position where the tension of the baling belts is relieved for maintenance work or troubleshooting on the deflection rolls. The baling belts can then be pushed sideways to allow access to the deflection rolls.

- ✓ The tailgate is closed.
- ✓ The left side hood is open.
- ▶ To move the tensioning rockers into position, move the lever (1) in the direction of the arrow and engage it behind the support / holder (2).
- ▶ To open the tailgate fully, actuate the control unit on the tractor (red, 1+).
- ▶ To close the tailgate to approx. halfway, actuate the control unit on the tractor (red, 1+).
- ➔ The baling belts are relieved and can be moved.
- ▶ To secure the tailgate, close the stop cock, [see Page 105](#).
- ▶ Switch off the tractor, remove the ignition key and take it with you.

17.12 Checking the screw connections on the drawbar

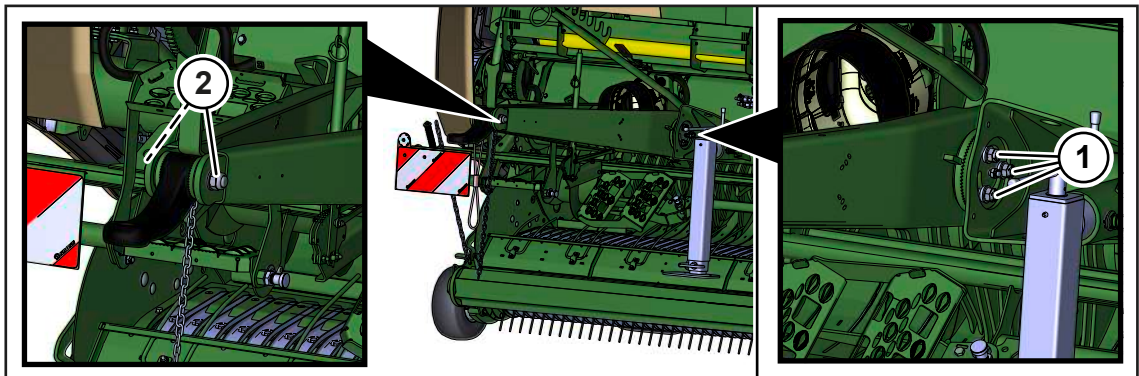

RPG000-088

- ✓ The machine has been shut down and secured, [see Page 28](#).
- ▶ Check that the screw connections (1) and (2) have been tightened to the correct tightening torque.
- ▶ Tighten the screw connections (1) on the drawbar to the tightening torque **210 Nm**.
- ▶ Tighten the screw connections (2) on the drawbar eye to the tightening torque **730 Nm**.

Maintenance interval, [see Page 207](#).

17.13 Checking and adjusting the cleaning rollers

For "Cleaning rollers" version

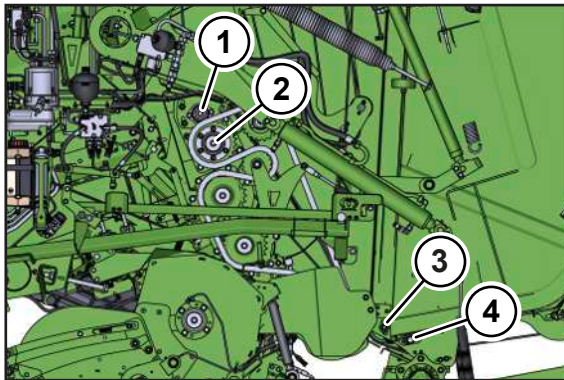

RP001-274

Here, the left side of the machine is shown as an example.

- | | |
|-------------------|--------------------|
| 1 cleaning roller | 3 Deflection shaft |
| 2 Drive shaft | 4 cleaning roller |

The 2 cleaning rollers (1) and (4) in the bale chamber ensure that crops are removed from the drive shaft (2) and the deflection shaft (3) at the bottom of the tailgate during operation.

The cleaning roller (4) does not need to be adjusted.

Maintenance interval: [see Page 207](#)

Checking cleaning roller on the drive shaft

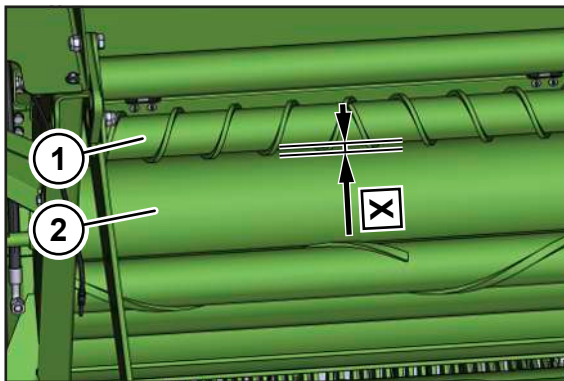

RP001-273

The distance between the cleaning roller (1) and the drive shaft (2) must be **X=3 ... 4 mm**.

- ▶ Relieve the baling belts, [see Page 224](#).
- ▶ Open the tailgate completely and secure it with the stop cock, [see Page 105](#).
- ▶ Shut down and safeguard the machine, [see Page 28](#).
- ▶ Check the distance between the cleaning roller (1) and the drive shaft (2).

Adjusting cleaning roller on the drive shaft

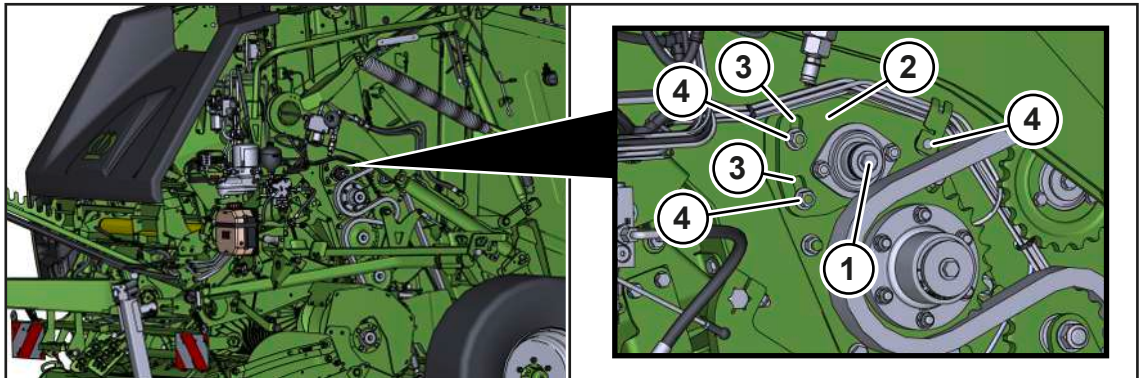

RP001-272

- ✓ The machine has been shut down and secured, [see Page 28](#).
- ▶ Loosen the screw connections (4) of the setting sheet (2) and move the sheet in the oblong holes (3). This moves the cleaning roller too.
 - ⇒ The distance between the cleaning roller and the drive shaft increases as the setting sheet (2) is moved upwards.
- ▶ Tighten the screw connection (4).

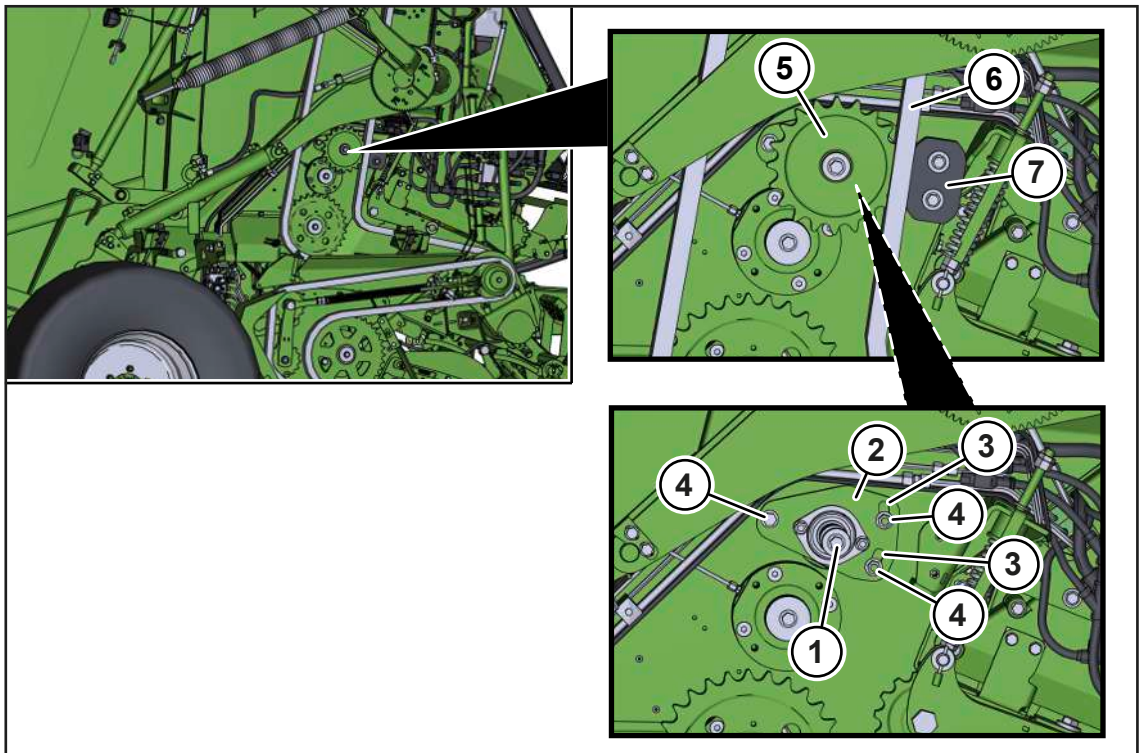

RP001-277

- ✓ The machine has been shut down and secured, [see Page 28](#).
- Adjust the cleaning roller on the right side of the machine to the same distance:
- ▶ Loosen the chain (6) and remove it from the sprocket wheel (5).
 - ▶ Dismount first the grinding block (7), then the sprocket wheel (5).
 - ▶ Loosen the screw connections (4) of the setting sheet (2) and move the sheet in the oblong holes (3). This moves the cleaning roller too.
 - ⇒ The distance between the cleaning roller and the drive shaft increases as the setting sheet (2) is moved upwards.

- ▶ Check the distance X between the cleaning roller and the drive shaft again.
- ➔ The distance is correct when it is **X=3 ... 4 mm**.
- ➔ Readjust the cleaning roller if the distance is not **X=3 ... 4 mm**.
- ▶ Tighten the screw connection (4).
- ▶ First mount the sprocket wheel (5), then the grinding block (7).
- ▶ Mount the chain (6) and adjust it if necessary, [see Page 235](#).

17.14 Checking and adjusting scraper on the feed roller

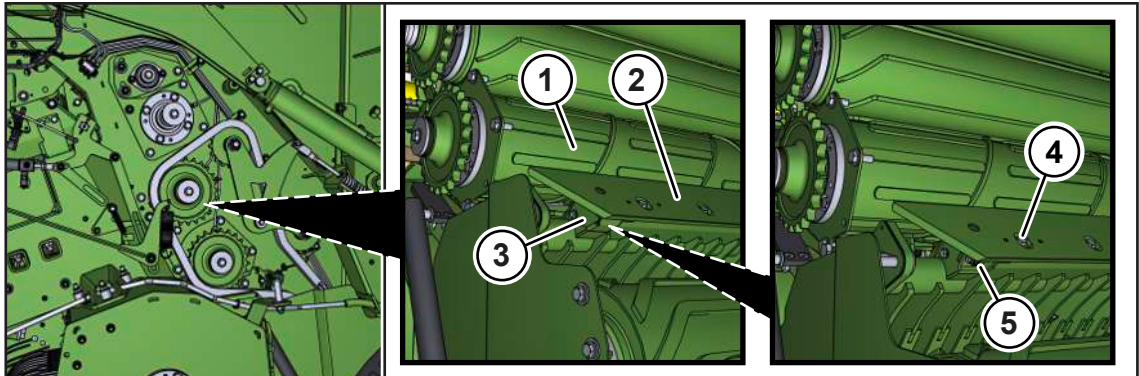

RP001-360

The scraper (2) on the feed roller (1) must be checked and adjusted at regular intervals.

- ✓ The tailgate is open and secured with the stop cock, [see Page 105](#).
- ✓ The machine has been shut down and secured, [see Page 28](#).
- ▶ Check that the scraper (2) has been set to contact the feed roller (1). Ensure that the scraper is not set too tightly so that chips fall off the feed roller.

If not, adjust the scraper (2) as follows:

- ▶ Dismount the cover (3).
- ▶ Loosen the 5 screw connections (4) on the scraper (2) but do not dismount.
- ▶ Using the screw connection (5), set the scraper (2) to contact the feed roller (1). Ensure that the feed roller (1) can still be turned by hand.
- ▶ Tighten the 5 screw connections (4) on the scraper (2).

17.15 Checking the fire extinguisher

For "support for fire extinguisher" version

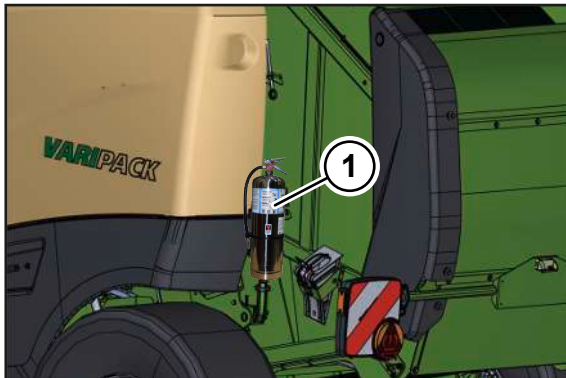

BPG000-034

- ✓ The machine has been shut down and secured, [see Page 28](#).
- ▶ Ensure that the fire extinguisher (1) is mounted on the machine.
- ▶ Ensure that access to and view of the fire extinguisher (1) are not obstructed.
- ▶ Ensure that the fire extinguisher (1) is filled by weighing the fire extinguisher (1).
- ▶ Ensure that the seal on the extinguishing head and the security seal are neither defective nor missing.
- ▶ Ensure that the operating instructions on the type plate of the fire extinguisher (1) are legible and face outwards.
- ▶ Check the fire extinguisher for visible material damage, corrosion, leakage, a clogged hose and/or nozzle.
- ▶ Ensure that the pressure gauge pointer indicates the green area.

17.16 Removing corrosion from net support / holder

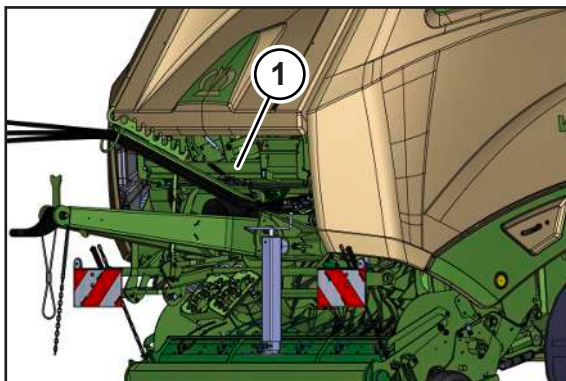

RPG000-157

- ✓ The machine has been shut down and secured, [see Page 28](#).
- ▶ Before starting the new season, remove corrosion from the net support / holder (1).

17.17 Releasing the cam clutch on the universal shaft

If the cam clutch was actuated during the baling process on the universal shaft due to an overload, proceed as follows:

- ▶ Switch off the PTO shaft.
- ▶ Switch on the PTO shaft at a lower idle speed until the cam clutch has engaged.
- ▶ Shift up the PTO shaft to rated speed.

17.18 Briefly deactivating cutting unit and pick-up

When performing maintenance work, e.g. when changing blades, the cutting unit and the pick-up can be mechanically deactivated for a short time.

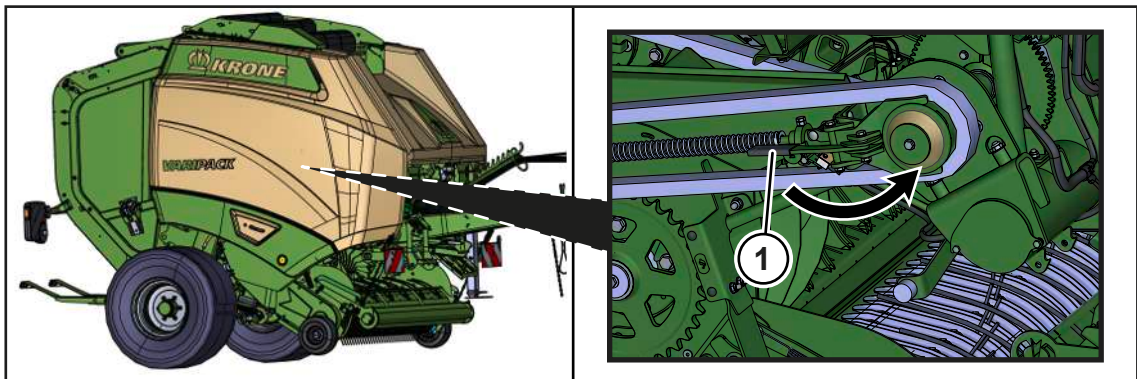

RPG000-162

- ✓ The machine has been shut down and secured, [see Page 28](#).
- ✓ The right side hood is open.
- ▶ To deactivate the cutting unit and the pick-up, move the lever (1) in the direction of the arrow.
- ▶ Before restarting the machine, activate the cutting unit and the pick-up and move the lever (1) against the direction of the arrow.

17.19 Changing the blades

Moving blades to maintenance position

- ▶ For "Operation unit DS 100" version: To preselect the blade cassette, press the  key, [see Page 108](#).

⇒ The indicator lamp below the key lights up.

- ▶ **For the other terminals** To preselect the blade cassette, press the  key on the terminal, [see Page 138](#).

⇒ The key changes to .

- ▶ To lower the blade cassette, actuate the control unit on the tractor (yellow, 3-).
- ➔ The blades and blade cassette are in maintenance position: The blades have been swivelled out and the blade cassette has been lowered.
- ▶ Unlock the blade retaining shaft, [see Page 231](#).

Removing the blades

 **WARNING**

Risk of injury due to sharp blades which have been pre-tensioned with spring force

When performing maintenance on the blade cassette, there is a risk of injury to fingers and hands due to sharp blades.

- ▶ When working on the blade cassette, work particularly carefully and prudently.
- ▶ When working on the blade cassette, always wear protective gloves.
- ▶ Never press the blades manually into working position. Instead, use a suitable auxiliary tool.
- ▶ Before working on the blade cassette, shut down and safeguard the machine, [see Page 28](#).

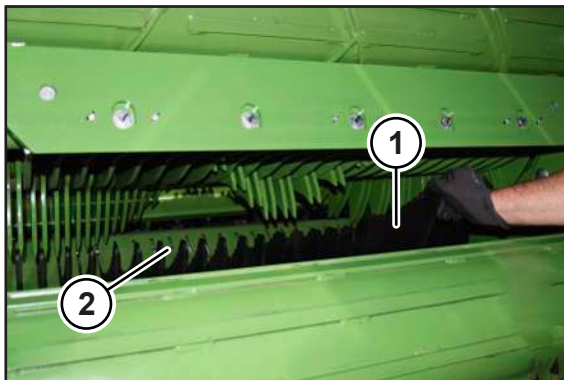

RPG000-251

- ✓ The pick-up is fully raised in transport position, [see Page 84](#).
- ✓ The tailgate is open and secured by the stop cock on the tailgate.
- ✓ The machine has been shut down and secured, [see Page 28](#).
- ▶ Remove the blades (1).
- ▶ Insert a new or a ground blade (1).
- ▶ Ensure that the blade (1) is correctly positioned on the blade control shaft and is centred in the slot (2).
- ▶ After inserting all blades (1), check that all blades (1) are in alignment.

INFO

If the cutting unit is not switched on for a prolonged period, the blades can be replaced with dummy blades in order to avoid soiling the blade cassette slots and wearing the blades.

The dummy blades can be ordered by quoting the following order number 20 469 670*.

17.20 Unlocking/locking blade retaining shaft

NOTICE
Damage to machine from unlocked blade retaining shaft

If the blade retaining shaft is not locked before commissioning, the blades can become loose during travel. This may damage the machine.

- ▶ Ensure that the blade retaining shaft is locked before putting the machine back into service.

If work has to be carried out on the blades of the cutting unit, the blade retaining shaft must be unlocked beforehand. After work, the blade retaining shaft must be locked again.

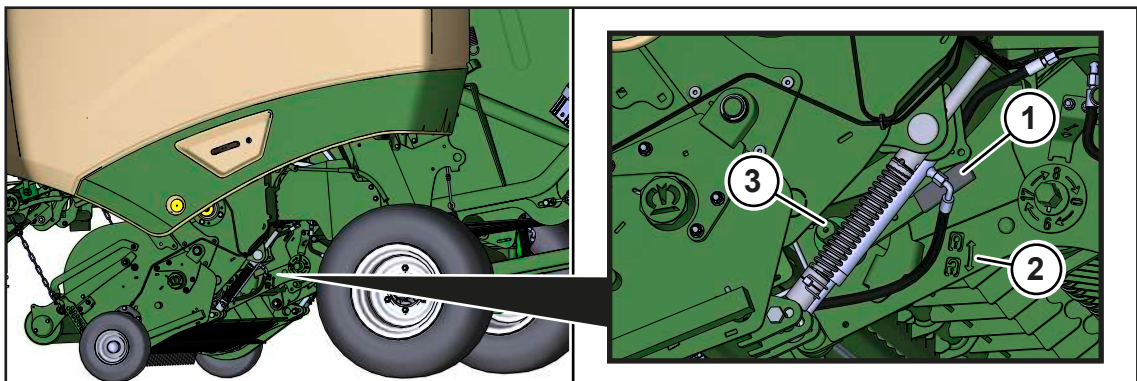

RPG000-156

- ✓ The machine has been shut down and secured, [see Page 28](#).

Unlocking

- ▶ Move the handle (1) downwards according to the sheet stamping (2) and engage.

Locking

- ▶ Move the handle (1) upwards according to the sheet stamping (2) and engage.
- ➔ After locking the blade retaining shaft (3), the blades selected beforehand swivel independently upwards into the working position.

17.21 Checking and moving the blade retaining shaft

Checking the blade retaining shaft

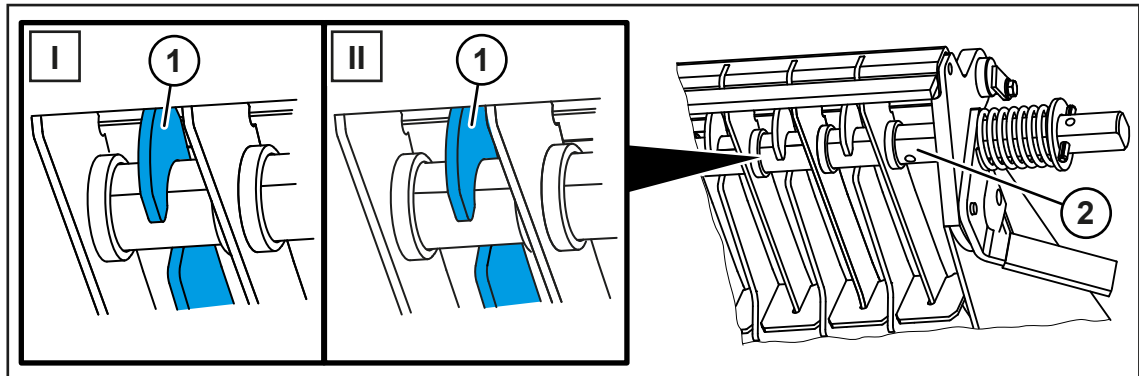

RPG000-160

The area on the blade retaining shaft (2), in which the blades (1) are located, wears during use.

The blade retaining shaft (2) is factory-set in position (I). If the area, in which the blades (1) are located, is worn by 1 mm in position (I), the blade retaining shaft (2) can be moved once into position (II). The blade retaining shaft (2) does not have to be replaced until the area, in which the blades (1) are located, even in position (II), is worn by 1 mm.

Moving the blade retaining shaft

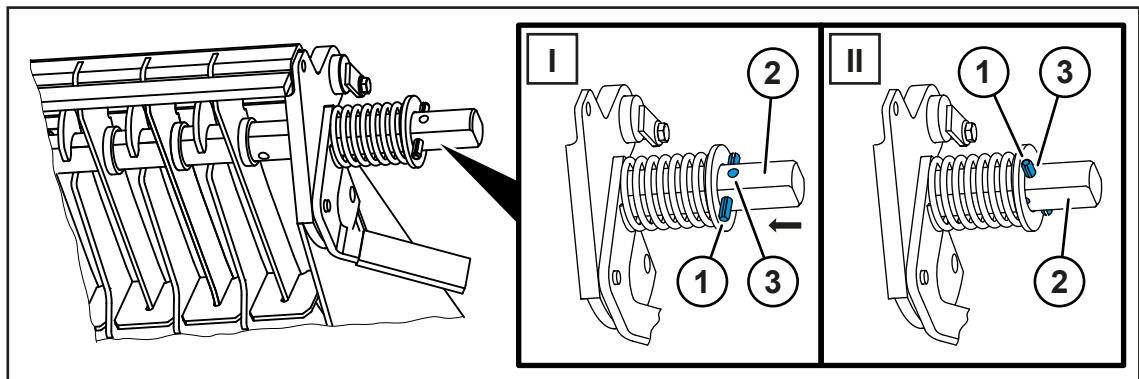

RPG000-161

✓ The blades have been removed, [see Page 229](#).

WARNING! Risk of injury from spring under tension! Proceed with special care when moving the blade retaining shaft.

- ▶ Knock out the roll pin (1) on both sides of the machine.
- ▶ Move the blade retaining shaft (2) by 8 mm.
- ▶ Knock the roll pin (1) into the opening (3) on both sides of the machine.
- ▶ Dismount the retaining ring (1) on both sides of the machine.
- ▶ Move the blade retaining shaft (2) in position (I).

If this groove on the blade retaining shaft is worn as well:

- ▶ Move the blade retaining shaft (2) in position (II).
- ▶ Mount a new retaining ring (1) on both machine sides.

17.22 Grinding the blades

INFO

KRONE recommend the KRONE blade grinding machine for grinding the blades.

Contact your KRONE dealer. For further information, please refer to the operating instructions of the blade grinding machine.

Correctly ground, sharp blades reduce fuel consumption and the wear on the cutting components. They also guarantee good cutting quality and ideal crop throughput.

The sharpness of the blades must be checked at least once a day. With crops with a high level of contamination/foreign bodies, checks must be performed several times a day.

Grinding blades without blade grinding machine

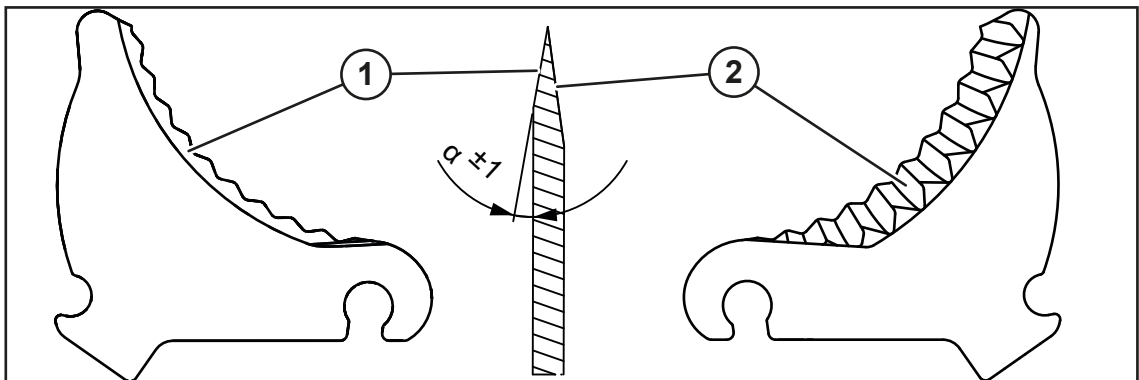

RPG000-112

1 Smooth blade side

2 Serrated blade

✓ The blade has been removed from the blade cassette, [see Page 229](#).

WARNING! Danger of cuts from sharp blades! Wear suitable protective gloves.

- ▶ Remove any coarse dirt deposited on the blade.
- ▶ Clamp the blade in a suitable vice.

WARNING! Danger of injury from flying sparks! During the grinding process, always wear protective gloves, hearing protection and safety glasses.

NOTE! During grinding, be sure not to heat the blade excessively and not to cut any notches as this will reduce the lifetime of the blade. Frequent grinding with pauses in between is better for the blade lifetime than excessively long grinding.

- ▶ Grind the cutting edge (1) maintaining an angle of ($\alpha=10$ degrees ± 1 degree)..
- ▶ Use suitable tools to touch up serrated blades (2).

17.23 Checking/lubricating the safety rolls of the single blade locking device

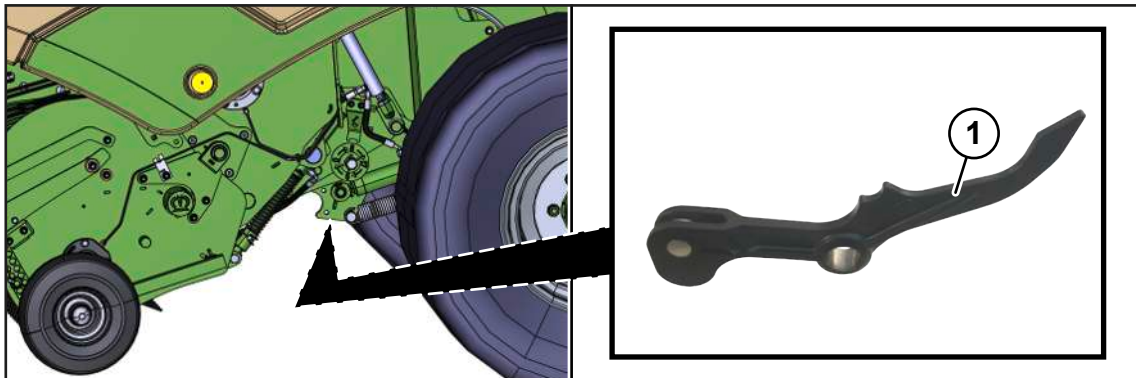

RPG000-252

The single blade locking device prevents the blades from being damaged when coming into contact with foreign objects. To allow the single blade locking device to function properly, ensure that the safety rolls on the blade levers (1) rotate smoothly.

Check whether the safety rolls run smoothly whenever you change a blade.

- ✓ The blades are in maintenance position, [see Page 229](#).
- ✓ The machine has been shut down and secured, [see Page 28](#).

The safety rolls on the blade levers (1) can be reached from below the machine.

- ▶ Rotate the safety rolls by hand to check their smooth movement.

If the safety rolls do not rotate smoothly:

- ▶ Lubricate the safety rolls with oil.

17.24 Adjust drive chains

⚠ WARNING

Risk of injury due to moving drive chains

When working on drive chains, there is a risk of injury due to entanglement of loose long hair or loose clothing.

- ▶ When working on the drive chains, wear protective equipment, [see Page 21](#).
- ▶ Before working on any drive chains, shut down and safeguard the machine, [see Page 28](#).

The drive chains on the machine are numbered consecutively. A number is stamped on a sheet on each chain.

Number	Drive chain	Location on the machine
1	Baling unit drive	Right side of machine
2	Rotor drive	Right side of machine
3	Feed roller and starter roller drive	Left side of machine

17.24.1 Drive chain of the baling unit (no. 1)

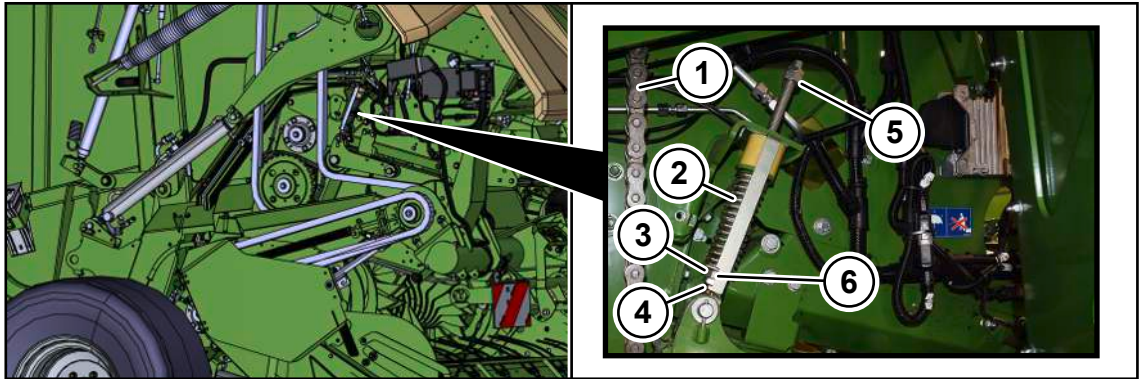

RPG000-172

The drive chain (1) of the baling unit is located on the right side of the machine. If the lower edge of the spring (2) is inside the notch (6), the drive chain (1) has been correctly set.

- ✓ The machine has been shut down and secured, [see Page 28](#).
- ✓ The right side hood is open.

Setting drive chain

- ▶ Using the nut (3) and counter nut (4), set the spring (2) so that the lower edge of the spring (2) is inside the notch (6).

Dismounting the drive chain

To dismount the drive chain (1), relieve the drive chain (1) as follows:

- ▶ Loosen the counter nut (4) and the nut (3) and screw downwards as far as possible.
- ▶ Screw the nut (5) downwards as far as possible.
 - ⇒ The spring is contracted.
- ▶ Remove the drive chain (1).

Mounting the drive chain

- ▶ Put on the drive chain (1).
- ▶ Screw the nut (5) all the way upwards again.
- ▶ Using the nut (3) and counter nut (4), set the spring (2) so that the lower edge of the spring (2) is inside the notch (6).

INFO

The drive chain is supplied with oil via the central chain lubrication system, [see Page 204](#).

17.24.2 Drive chain of the rotor (no. 2)

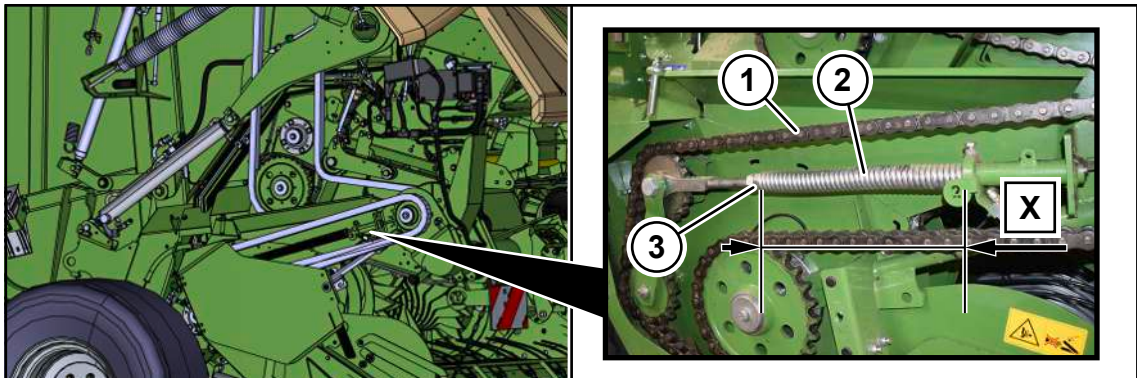

RPG000-171

The drive chain (1) of the rotor is located on the right side of the machine. The dimension X of the tensioned spring length (2) must be $X=370$ mm when the pick-up is raised.

- ✓ The machine has been shut down and secured, [see Page 28](#).
- ✓ The pick-up is fully raised in transport position, [see Page 84](#).
- ✓ The right side hood is open.
- ▶ To tension the drive chain (1), use the nut (3) to set the dimension $X=370$ mm.
- ▶ Lock the nut (3).

INFO

The drive chain is supplied with oil via the central chain lubrication system, [see Page 204](#).

17.24.3 Drive chain of the feed roller and the starter roller (no. 3)

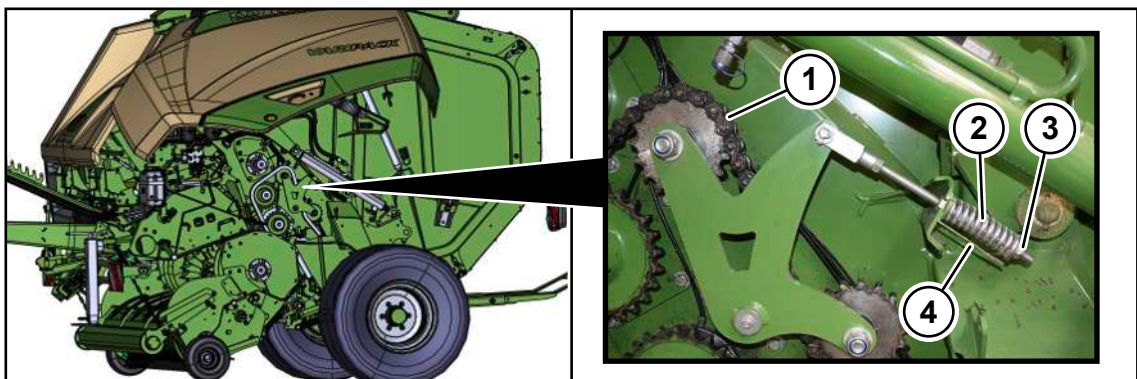

RPG000-173

The drive chain (1) of the feed roller and the starter roller is located on the left side of the machine. If the spring (2) has been tensioned to the dimension of the sheet (4), the drive chain (1) has been correctly set. In doing so, the lower edge of the spring (2) must be sealed by the lower edge of the sheet (4).

- ✓ The machine has been shut down and secured, [see Page 28](#).
- ✓ The left side hood is open.
- ▶ To tension the drive chain (1), use the nut (3) to set the spring (2) to the dimension of the sheet (4).

INFO

The drive chain is supplied with oil via the central chain lubrication system, [see Page 204](#).

17.25 Servicing chain lubrication unit

NOTICE

Damage to the machine due to the use of incorrect and contaminated lubricants

Unauthorised or contaminated lubricants in the central chain lubrication unit will cause malfunctions in the central chain lubrication unit and damage the bearing positions.

- ▶ When working on the central chain lubrication unit, use clean and suitable tools.
- ▶ Use authorised lubricants only.
- ▶ Ensure that dirt or dirty lubricant cannot get into the central chain lubrication unit.

17.25.1 Checking oil level, topping up oil and cleaning filter

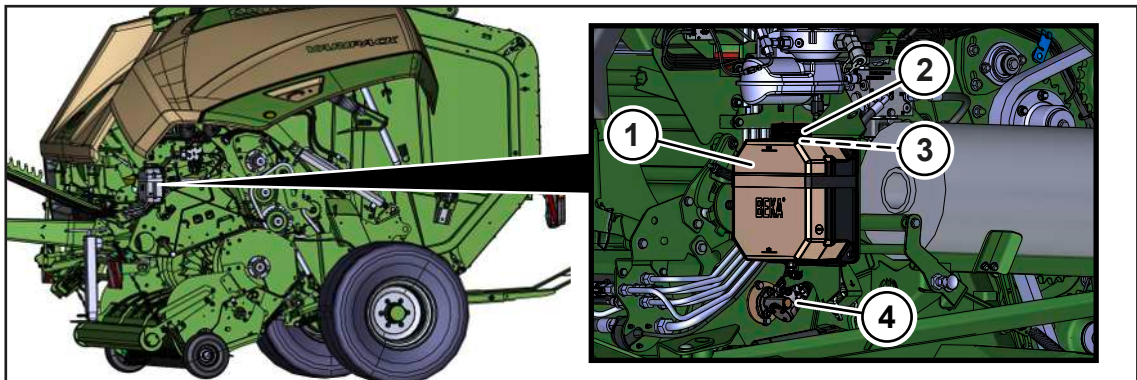

RPG000-134

- 1 Reservoir
- 2 Cover

- 3 Filter
- 4 Oil pump

Checking oil level and topping up oil

- ✓ The machine has been shut down and secured, [see Page 28](#).

NOTE! Risk of machine damage due to improperly performed oil level check, oil and filter element change! Follow the safety routine "Oil level check. Changing oil and filter elements safely", [see Page 29](#).

- ▶ Read off the oil level on the reservoir (1).
- ▶ If the oil level is too low, remove the cover (2) and top up the oil via the opening. For a list of oils, [see Page 53](#).
- ▶ Mount the cover (2).

Cleaning the filter

- ✓ The machine has been shut down and secured, [see Page 28](#).
- ✓ The reservoir (1) is mostly empty.
- ▶ Remove the cover (2).
- ▶ Remove the filter (3) from the reservoir (1).
- ▶ Clean the filter (3).
- ▶ Mount a clean filter (3).
- ▶ Fill the reservoir (1) with oil.
- ▶ Mount the cover (2).

17.25.2 Position of the oil brushes

The oil brushes are located on the 3 drive chains which are identified on the machine by numbers.

Right side of machine

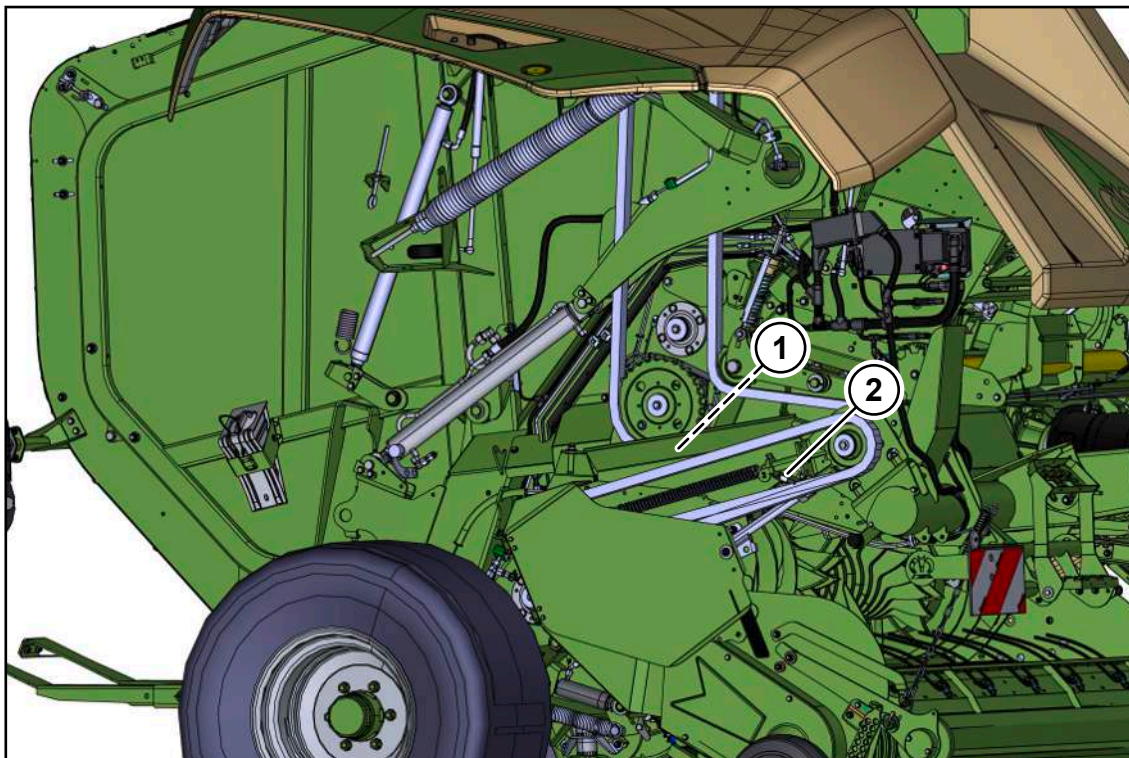

RPG000-175

1 Drive chain no. 1 – baling unit

2 Drive chain no. 2 – rotor

Left side of machine

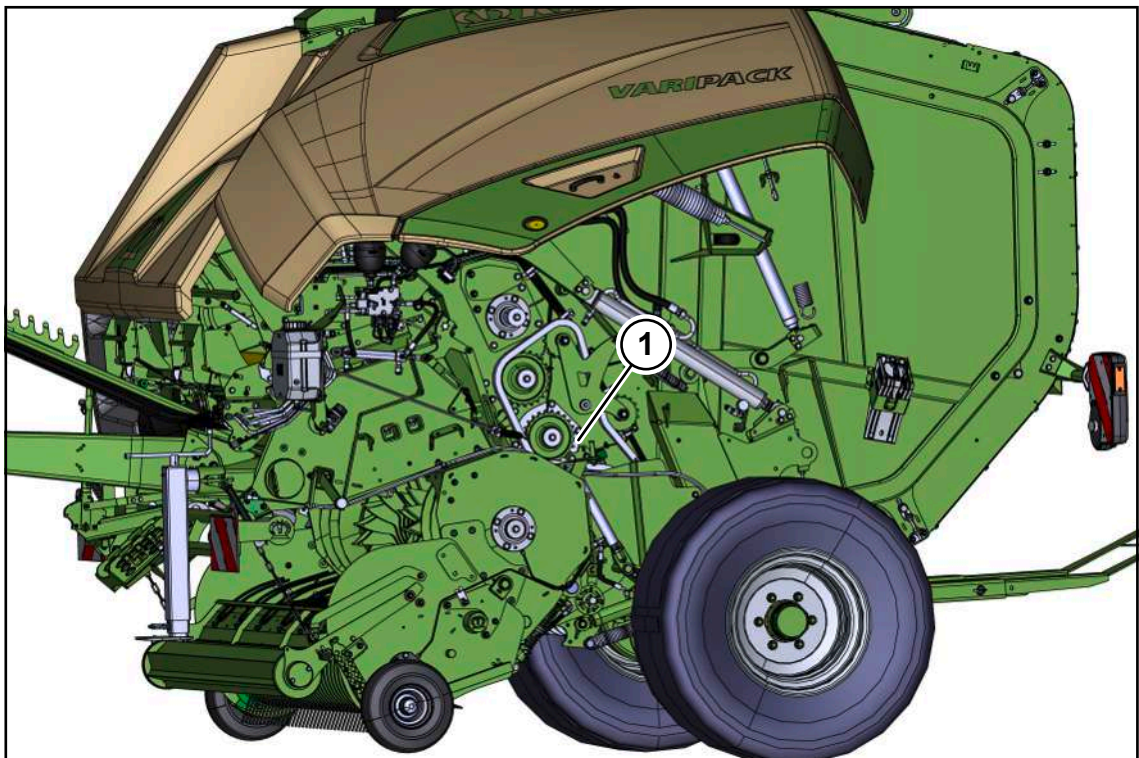

RPG000-176

- 1 Drive chain no. 3 – feed roller and starter roller

17.26 Servicing compressed air brake (for version with "Compressed air brake")

17.26.1 Clean air filter

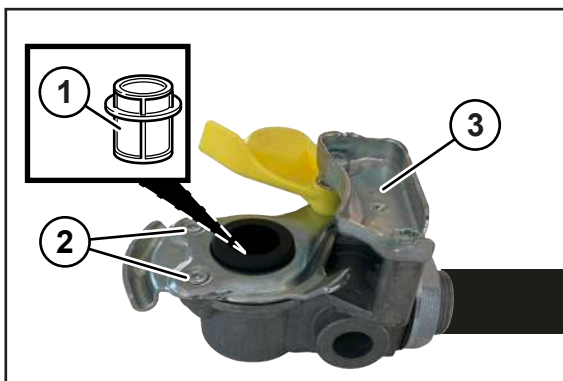

RP001-015

The filter element (1) of the air filter sits in the two compressed-air connections (3) of the machine. The air filters clean the compressed air and protect the compressed air brake against malfunctions. The compressed-air brake remains functional in both flow directions even when a filter element is obstructed.

- ✓ The machine has been shut down and secured, [see Page 28](#).

Use the following procedure to clean the filter elements in the supply line (red coupling head) and in the brake line (yellow coupling head):

- ▶ Dismount the screw connections (2).
- ▶ Remove the filter element (1).
- ▶ Re-insert the filter element (1).
- ▶ Mount the screw connections (2).

17.26.2 Drain condensation water from the compressed air tank

⚠ WARNING

Risk of injury from corroded or damaged compressed air reservoirs

Damaged or corroded compressed air reservoirs may burst and cause serious injuries.

- ▶ Observe the inspection intervals according to maintenance table, [see Page 207](#).
- ▶ Have damaged or corroded compressed air reservoirs replaced immediately by a specialist workshop.

NOTICE

Damage to compressed air reservoir caused by water in the compressor unit

Water in the compressor unit leads to corrosion which damages the compressed air reservoir.

- ▶ Check and clean drain valve according to maintenance table, [see Page 207](#).
- ▶ Immediately replace a defective drain valve.

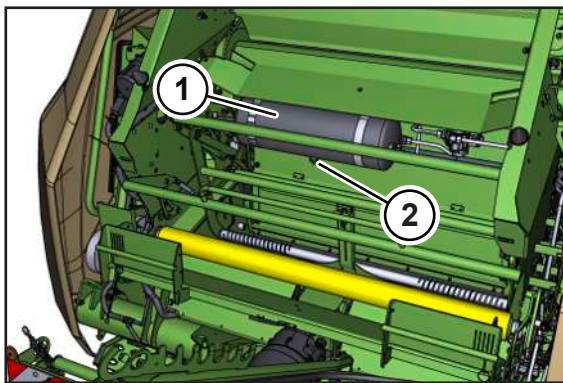

DVG000-014

The compressed-air reservoir stores the compressed air that is pumped by the compressor.

Condensation water may settle in the compressed air reservoir (1) during operation. The compressed-air reservoir (1) must be emptied regularly, [see Page 207](#).

The drain valve (2) is on the underside of the compressed air reservoir (1).

- ▶ Shut down and safeguard the machine, [see Page 28](#).

WARNING! Risk of eye injury due to spurting condensation water! Wear suitable protective goggles.

- ✓ A suitable container is available for escaping condensation water.
- ▶ Open the drain valve (2).
- ➔ Allow compressed air and condensation water to escape out of the compressed-air tank (1).
- ▶ Visually inspect the drain valve (2) to ensure that it is not defective or soiled.
- ➔ If the drain valve (2) is defective and is no longer sealed, immediately have the drain valve (2) replaced by a KRONE service partner.
- ➔ If the drain valve (2) is soiled, clean the drain valve (2).

17.26.3 Retighten tensioning straps at the compressed air tank

For an overview of the tightening torques, [see Page 215](#).

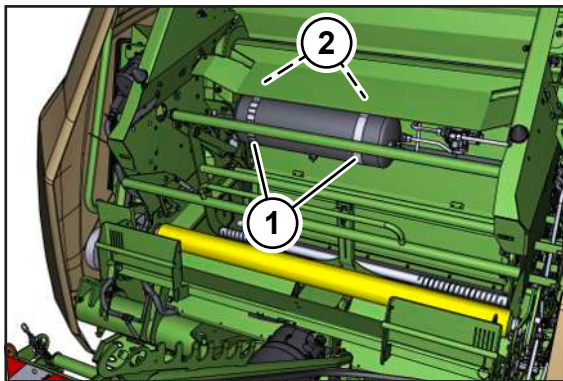

DVG000-015

- ▶ Shut down and safeguard the machine, [see Page 28](#).
- ▶ Check that the tensioning straps (1) are firmly attached.

If the compressed-air tank cannot be turned by hand, the tensioning straps (1) have been correctly set.

If the compressed-air tank can be turned by hand, the tensioning straps (1) must be retensioned.

- ▶ To tension the tensioning straps (1), tighten the nuts (2).

17.27 Servicing the hydraulic system

WARNING

Hydraulic hoses are subject to ageing

Hydraulic hoses may wear depending on pressure, heat load and the effect of UV rays. People can be seriously injured or killed by damaged hydraulic hoses.

The date of manufacture appears on the hydraulic hoses. This way the age can be ascertained quickly.

Replacement of the hydraulic hoses is recommended after a lifetime of six years.

- ▶ Use original spare parts when replacing hoses.

NOTICE

Damage to the machine due to soiling of the hydraulic system

If foreign objects or liquids get into the hydraulic system, the hydraulic system may be severely damaged.

- ▶ Clean hydraulic connections and components before removal.
- ▶ Seal open hydraulic connections with protective caps.
- ▶ Ensure that foreign objects or liquids do not get into the hydraulic system.

NOTICE

Storing and disposing of oils and used oil filters

If oil and used oil filters are not stored and disposed of properly, the environment may be damaged.

- ▶ Store or dispose of used oil and oil filters according to statutory provisions.

17.27.1 Before working on the hydraulic system

The following steps must be performed before working on the hydraulic system to completely de-pressurise the hydraulic system:

- ▶ Close the tailgate.
- ▶ Reduce the baling pressure via the terminal in the menu "Electronic baling pressure

setting"  , see Page 164.

- ▶ Shut down and safeguard the machine, see Page 28.

17.27.2 Checking hydraulic hoses

Hydraulic hoses are subject to natural aging. This limits their service life. The recommended service life is 6 years, including a maximum storage time of 2 years. The date of manufacture is printed on the hydraulic hoses. When checking hydraulic hoses, the state-specific conditions (e.g., BGVU) must be observed.

Performing a visual inspection

- ▶ Visually inspect all hydraulic hoses for damage and leaks and have them replaced by an authorised specialist if necessary.

18 Malfunction, cause and remedy

 WARNING
<p>Risk of injury due to non-observance of relevant safety notices</p> <p>If the relevant safety notices are not observed, persons may get seriously injured or killed.</p> <ul style="list-style-type: none"> ▶ To avoid accidents, the basic safety instructions must be read and observed, see Page 16.

 WARNING
<p>Risk of injury due to non-observance of safety instructions</p> <p>If the relevant safety routines are not observed, persons may be seriously injured or killed.</p> <ul style="list-style-type: none"> ▶ The safety routines must be read and observed to avoid accidents, see Page 28.

18.1 Disturbances at the pick-up or during picking up of crops

Malfunction: The pick-up cannot be lowered.

Possible cause	Remedy
There was no switchover to pick-up on the terminal.	<ul style="list-style-type: none"> ▶ Pre-select pick-up on the terminal by pressing the  key.
The hydraulic hose has not been inserted in the tractor.	<ul style="list-style-type: none"> ▶ Correctly connect the hydraulic hose for the pick-up, see Page 61.
The working height of the pick-up is set too high that the pick-up cannot be lowered.	<ul style="list-style-type: none"> ▶ Set the working height of the pick-up, see Page 85.

Malfunction: There are crop blockages in the intake area.

CAUTION! Machine damage due to crop blockages! Immediately stop, switch off PTO shaft and remove the crop blockages.

Possible cause	Remedy
The swaths are uneven or too large.	<ul style="list-style-type: none"> ▶ Divide the swaths.
The tractor driver is driving too fast.	<ul style="list-style-type: none"> ▶ Reduce the driving speed.
The machine height has not been set correctly with respect to the tractor.	<ul style="list-style-type: none"> ▶ Set the machine correctly using the drawbar from the KRONE service partner, see Page 55.
The crop press roller unit has been set too low.	<ul style="list-style-type: none"> ▶ Set the crop press roller unit higher, see Page 87.

To remove the crop blockages, [see Page 105](#).

Malfunction: Crops are conveyed upwards by the baling belts.

Possible cause	Remedy
The drop shaft in front of the bale chamber is blocked.	<ul style="list-style-type: none"> ▶ Remove the crops from the drop shaft.
The crops have a dry, long, reedy and/or smooth quality.	<ul style="list-style-type: none"> ▶ First set the core to a baling pressure of 0-20% with a diameter of 80 cm in menu 6 "Electronic baling pressure setting", see Page 163. ▶ At the start of the baling process, reduce the rotational speed by 20-25 % and reduce the baling pressure. ▶ In addition, quickly pick up the swath at the start. ▶ From a bale diameter of approx. 80 cm the rotational speed and the baling pressure can be increased again.
The density of the bale core has been set too solid.	<ul style="list-style-type: none"> ▶ Adjust the density of the bale core via the terminal, see Page 163.

Malfunction: The baling belts have become entangled.

Possible cause	Remedy
The baling belts have become entangled or stacked on top of each other and are no longer next to each other.	<ul style="list-style-type: none"> ▶ Sort the baling belts, see Page 256. ▶ During the next baling process, fill the bale chamber more evenly, see Page 77.

Disturbance: The cam clutch releases. There is a blockage in the system.

Possible cause	Remedy
Crops accumulate between the feed rollers.	<ul style="list-style-type: none"> ▶ Reduce the baling pressure in the bale core, see Page 163. ▶ Start the baling process at reduced rotational speed. ▶ Pick up crops swiftly and increase the crop intake.

18.2 Disturbances during or after the baling process

Malfunction: The baling belts turn slower than they should. Slippage occurs when starting the bale (up to a bale diameter of about 80 cm).

Possible cause	Remedy
The crops consist of very heavy grass without structure (e.g. clover grass).	<ul style="list-style-type: none"> ▶ Increase the baling pressure of the bale core, see Page 163. ▶ Fill the bale chamber quickly with crops by increasing driving speed or swath size. ▶ Reduce the rotational speed. ▶ Drive with few or no blades. To swivel out blade groups, see Page 91.

Malfunction: The baling belts turn slower than they should. Slippage occurs when starting the bale (from a bale diameter of about 80 cm).

Possible cause	Remedy
The baling pressure is too high.	▶ Reduce the baling pressure, see Page 200 .
The rotational speed is too high.	▶ Reduce the rotational speed.
The crops consist of very heavy grass without structure (e.g. clover grass).	▶ Drive with few or no blades. To swivel out blade groups, see Page 91 . ▶ For longer driving in the headland, switch the PTO shaft off.

Malfunction: The direction display during the baling process reacts too sensitively.

Possible cause	Remedy
The sensitivity of the direction display has been set too high on the terminal.	▶ For version with "operation unit DS 100": Set the sensitivity of the direction display on the operation unit, see Page 115 . ▶ For the remaining terminals: Set the sensitivity of the direction display on the terminal, see Page 164 .

Malfunction: The baling density is too low.

Possible cause	Remedy
The baling pressure is too low.	▶ Increase the baling pressure, see Page 200 .
There is a fault in the tensioning hydraulics.	▶ Contact the KRONE service partner.

Malfunction: The round bale does not roll, or only slowly, out of the bale chamber.

Possible cause	Remedy
The sides have been filled too high.	▶ Make narrower swaths, see Page 77 . ▶ Do not drive too far to the side.
The baling pressure is too high.	▶ Reduce the baling pressure, see Page 200 .
The tensioning hydraulics are faulty.	▶ Have the tensioning hydraulics checked by a KRONE service partner.

Disturbance: The round bale does not roll far enough out of the bale chamber. The tailgate damages the wrapping and tying material when it closes.

Possible cause	Remedy
The tailgate was closed early.	▶ Ensure that the tailgate is closed only after the round bale has been ejected.
The bale ejector is not set correctly to the size of the round bale.	▶ Adjusting the bale ejector, see Page 205 .

Malfunction: The machine is running unevenly and the baling process in the bale chamber is difficult to start.

Possible cause	Remedy
The density of the bale core is too high.	▶ Reduce the density of the bale core, see Page 163 .

Malfunction: The tailgate cannot be completely closed.

Possible cause	Remedy
The stop cock for the tailgate is closed.	▶ Open the stop cock, see Page 105 .
There are crops between the front housing and the tailgate.	▶ Remove the crops.

Malfunction: The tailgate cannot be opened.

Possible cause	Remedy
The hydraulic hose line for "Opening/closing tailgate" has not been correctly connected.	▶ Connect the hydraulic hose line for "Opening/closing tailgate", see Page 61 .
The stop cock for the tailgate is closed.	▶ Open the stop cock, see Page 105
The pressure limiting valve for the tensioning hydraulics is not depressurising.	▶ Checking the light-emitting diode on the pressure limiting valve, see Page 255 .

Malfunction: The round bale is conically shaped.

Possible cause	Remedy
The bale chamber is filled on one side.	▶ Fill the bale chamber evenly, see Page 77 .
Net wrapping: The number of net layers is too low.	▶ Increase the number of net layers via the terminal, see Page 161 .
The wrapping material is torn.	▶ Use only wrapping material of the designated quality. KRONE recommends one of the "KRONE excellent" products, see label on the machine with the number 27 016 326 *.

Malfunction: The round bale is barrel-shaped. This causes the wrapping material to tear open in the middle.

Possible cause	Remedy
The bale chamber is filled unevenly.	▶ Drive over the swath on alternate sides, see Page 77 .
The number of layers of wrapping material is too low.	▶ Increase the number of layers. KRONE recommends 4 net layers for net wrapping. Net wrapping: see Page 161 . Twine tying: see Page 161

18.3 Disturbances at the tying unit or during the tying cycle

Malfunction: The net is not transported after tying starts.

With this malfunction an error message is displayed on the terminal.

Possible cause	Remedy
The net roll is empty.	▶ Change the net roll, see Page 94 .
The net roll has the wrong dimensions.	▶ Only use net rolls with the prescribed dimensions, see Page 51 .
The net roll has not been correctly inserted into the roll support / holder.	▶ Insert the net roll according to the description, see Page 94 .

Possible cause	Remedy
The net has not been correctly inserted.	▶ Insert the net according to the description, see Page 96 .
The ratchet brake is not releasing.	▶ Check mechanical components of the ratchet brake. The ratchet must unhook when the net is being fed, see Page 251 .
The net overhang is not approx. 10 cm and is therefore too short.	▶ Set the net overhang on the wrapping material brake, see Page 200 .
The lower rubber cloth does not adequately touch the lower feed roller. The rubber cloth must be 2-3 cm at full width on the feed roller.	▶ If the rubber cloth is no longer 2-3 cm at full width on the feed roller, adjust the rubber cloth, see Page 201 .
	▶ If the actuator for wrapping process was not completely extended, check the position in the sensor test and save again, see Page 186 .
	▶ Check again whether the adjusted rubber cloth is 2-3 cm on the feed roller.
	▶ If the rubber cloth is heavily worn, replace the rubber cloth.

Malfunction: The net is not, or not cleanly, cut.

CAUTION! Risk of injury on sharp parts! Always wear suitable protective gloves when you remove contamination at the cutting unit.

Possible cause	Remedy
The cutting unit is blunt.	▶ Remove deposits from the cutting unit. ▶ If required, have the cutting unit replaced by a KRONE service partner.
The cutting unit is not actuated.	▶ Remove debris from the cutting unit inside the bale chamber and outside on the left side of the machine.
The actuator for wrapping process is defective.	▶ Check the actuator for wrapping process.
The ratchet on the wrapping material brake is jamming.	▶ Check the ratchet on the wrapping material brake, see Page 251 .

Disturbance: The net stops during activated tying. The net tears after tying starts or during the tying cycle.

With this malfunction an error message is displayed on the terminal.

CAUTION! Risk of injury on sharp parts! Always wear suitable protective gloves when you remove contamination at the cutting unit.

Possible cause	Remedy
The cutting unit is not engaged.	▶ Remove deposits from the cutting unit. ▶ Check the positions of the feed rocker arm, see Page 252 .

Malfunction: The net is damaged during the tying process.

Possible cause	Remedy
There are deposits or minor damage on the machine components, the sharp edges of which are damaging the net.	▶ Check and clean the components along the net path. ▶ Remove sharp edges from along the net path. ▶ If the malfunction persists, contact the KRONE service partner.

Disturbance: The net does not, or not completely, cover one or both of the outer edges.

Possible cause	Remedy
The net is not correctly braked during the tying cycle.	▶ Check the positions of the feed rocker arm and remove any deposits, see Page 252 .
The net roll has not been centred on the machine.	▶ Correctly insert the net roll and centre it on the machine, see Page 94 .

18.4 Malfunctions on the chain lubrication unit

Malfunction: The oil consumption is too low.

Possible cause	Remedy
The oil quantities have been set too low. Too little oil comes from the brushes on the central chain lubrication unit, see Page 238 .	▶ Set the oil quantities on the affected drive chains higher, see Page 204 .
The oil is too thick.	▶ Use recommended oil, see Page 52 .
The central chain lubrication system is contaminated.	▶ Clean the entire central chain lubrication system.

Malfunction: The oil consumption is too high.

Possible cause	Remedy
The oil quantities are set too high. Too much oil comes from the brushes on the central chain lubrication unit, see Page 238 .	▶ Set the oil quantities on the affected drive chains lower, see Page 204 .
The oil is too thin.	▶ Use recommended oil, see Page 52 .

Malfunction: The oil pump is dry.

Possible cause	Remedy
There is no pressure. The oil pump is not conveying.	▶ Have the oil pump dismantled and cleaned or replaced by a KRONE service partner.
There is no pressure. The system has no oil.	▶ Check the oil level and top up, see Page 237 .
The system is blocked by deposits.	▶ Clean the entire central chain lubrication system.

Malfunction: The oil pump is not pressed for the complete stroke.

Possible cause	Remedy
The oil is too thick.	▶ Use recommended oil, see Page 52 .

18.5 Faults of the electrics/electronics

18.5.1 Error Messages

 **WARNING**

Risk of injury to persons and damage to machines if error messages are ignored

If error messages are ignored and the fault is not rectified, there is a risk of injury to persons and/or severe damage to the machine.

- ▶ When an error message is displayed, eliminate the disturbance; see chapter "Error list" in the supplement to operating instructions "Error messages".
- ▶ If the fault cannot be rectified, contact KRONE service partner.

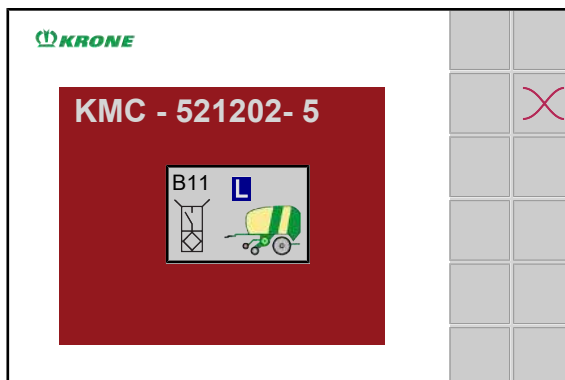



EQG000-034

If the machine malfunctions, the display shows an error message. At the same time, an acoustic signal sounds (continuous horn signal). For a list of the error messages, see chapter "Error list" in the supplement to operating instructions "Error messages".



Configuration of an error message

The error message is configured according to the following sample: e.g. error message

"520192-19 

520192	19	
SPN (Suspect Parameter Number) = error number	FMI = type of error, see Page 250	Icon

Acknowledging error message

- ▶ Note down the error message.
- ▶ Briefly press on .
- ➔ The acoustic signal stops and the error display is no longer indicated. The error message is displayed again if the fault occurs again.
- ▶ To acknowledge the error message until the operating terminal is next started, press and hold down the  key for 5 seconds.
- ▶ Eliminate the fault. See Chapter "Error list" in the supplement to the operating instructions "Error messages".

Acknowledged and still pending error messages can be displayed again via the "Error list" menu or the status line.

18.5.1.1 Possible error types (FMI)

There are different types of errors which are shown under the term FMI (Failure Mode Identification) with an appropriate code.

FMI	Meaning
0	The upper limit value was greatly exceeded.
1	The lower limit value was far below the required one.
2	The data is not permitted.
3	There is an overvoltage or a short circuit to supply voltage.
4	There is an undervoltage or a short circuit to ground.
5	A cable is broken or amperage is too low.
6	There is a short circuit to ground or amperage is too low.
7	The mechanics do not respond or the expected result was not achieved.
8	The frequency is not permitted.
9	There is an abnormal update rate.
10	There is an abnormal rate of change.
11	The error cause is unknown.
12	There is an internal error.
13	The values of the calibration are outside the value range.
14	Particular instructions are required.
15	The upper limit value has been reached.
16	The upper limit value has been exceeded.
17	The lower limit value has been reached.
18	The lower limit value has not been reached.
19	There is a CAN communication failure.
20	The data deviates upwards.
21	The data deviates downwards.
31	The condition has been fulfilled.

18.5.2 Remedying sensor/actuator error

Only a qualified specialist workshop is allowed to repair or to replace components.

Before contacting the dealer, collect the following information about the error message:

- ▶ Note down the error number shown on the display with the FMI, [see Page 249](#).
- ▶ Shut down and safeguard the machine, [see Page 28](#).
- ▶ Check sensor/actuator externally for damage.
- ➔ Replace the sensor/actuator, if it shows any damage.
- ➔ If the sensor/actuator is not externally damaged, continue with the next test step.
- ▶ Check connector cable and plug connection for damage and firm seat.
- ➔ Replace connector cable/plug connection, if they show any damage.
- ➔ If connector cable/plug connection are not externally damaged, continue with the next test step.

Each additional piece of information you give to the dealer makes it easier to eliminate the cause of the fault.

18.6 Checking the ratchet on the wrapping material brake

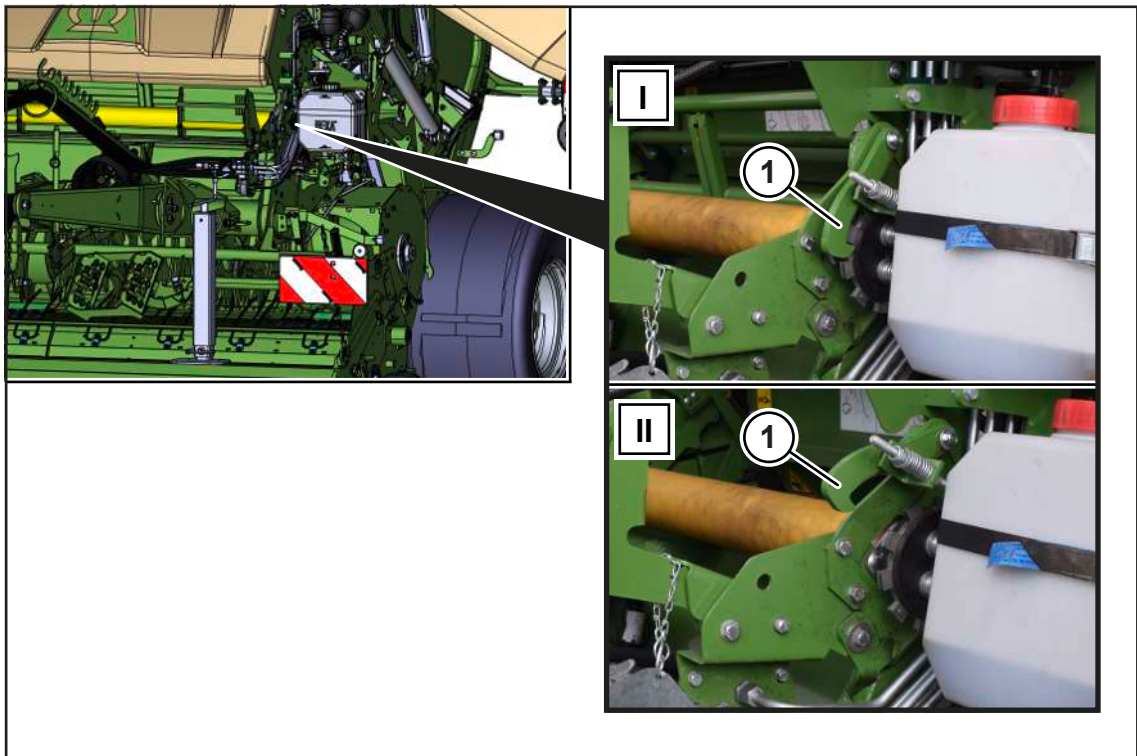

RPG000-195

This net wrapping ratchet (1) is located on the left side of the machine.

Depending on the position of the feed rocker arm, the ratchet (1) is either engaged (Position (I)) or not engaged (Position (II)).

For an overview of the positions of the feed rocker arm, [see Page 252](#).

Position	Explanation
(I)	Ratchet engaged <ul style="list-style-type: none"> • Final position
(II)	Ratchet not engaged <ul style="list-style-type: none"> • Feed position • Tying position

- ▶ Approach the individual positions of the feed rocker arm, [see Page 252](#).
- ▶ Check whether the ratchet (1) is in the correct position (I) or (II).

If the ratchet (1) blocks:

- ✓ The machine has been shut down and secured, [see Page 28](#).
- ▶ Remove deposits from the tying unit.

18.7 Checking positions of the feed rocker arm

When manually operating the terminal, the feed rocker arm can be moved to the end position, feed position and tying position, [see Page 167](#).

The positions of the feed rocker arm can be checked on the left side of the machine.

Final position

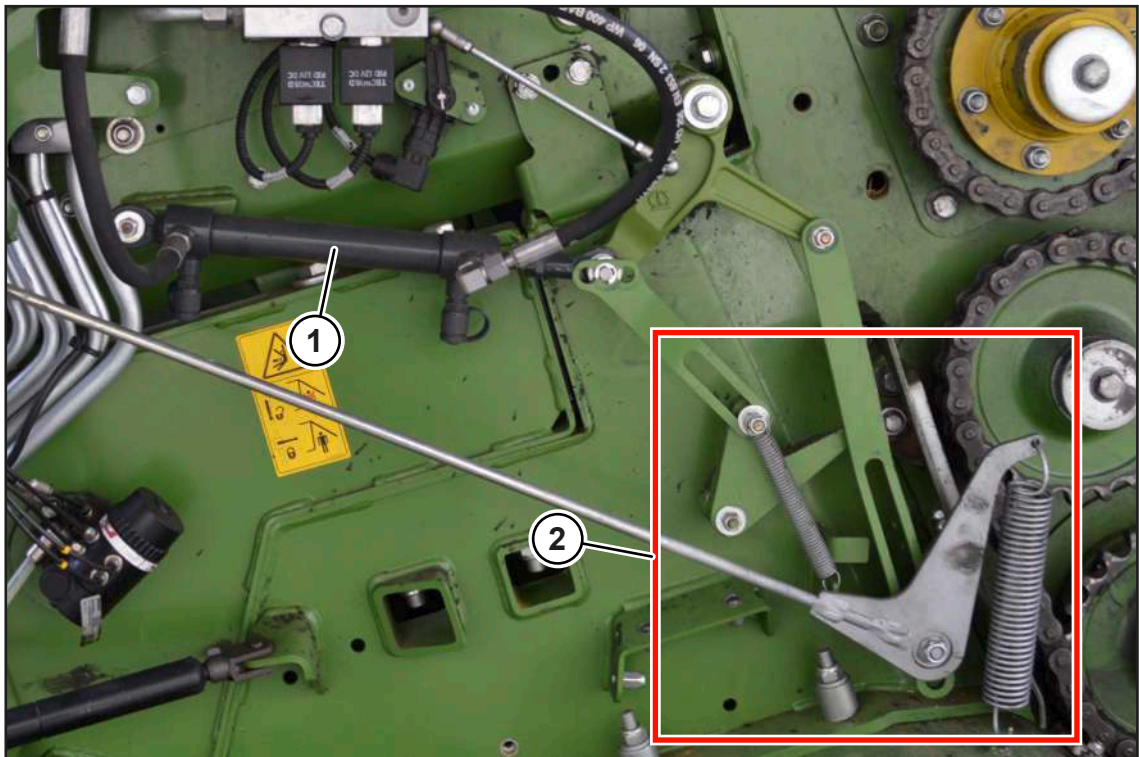

RP000-994

The end position is the basic position in which the tying unit is always located when no tying cycle is running. The cylinder (1) has been completely retracted.

- ▶ In Menu 10 "Manual operation" move the feed rocker arm into the end position by pressing the  key.
- ▶ Check whether the cylinder (1) has been completely retracted and the area (2) looks the same as the one illustrated.

Feed position

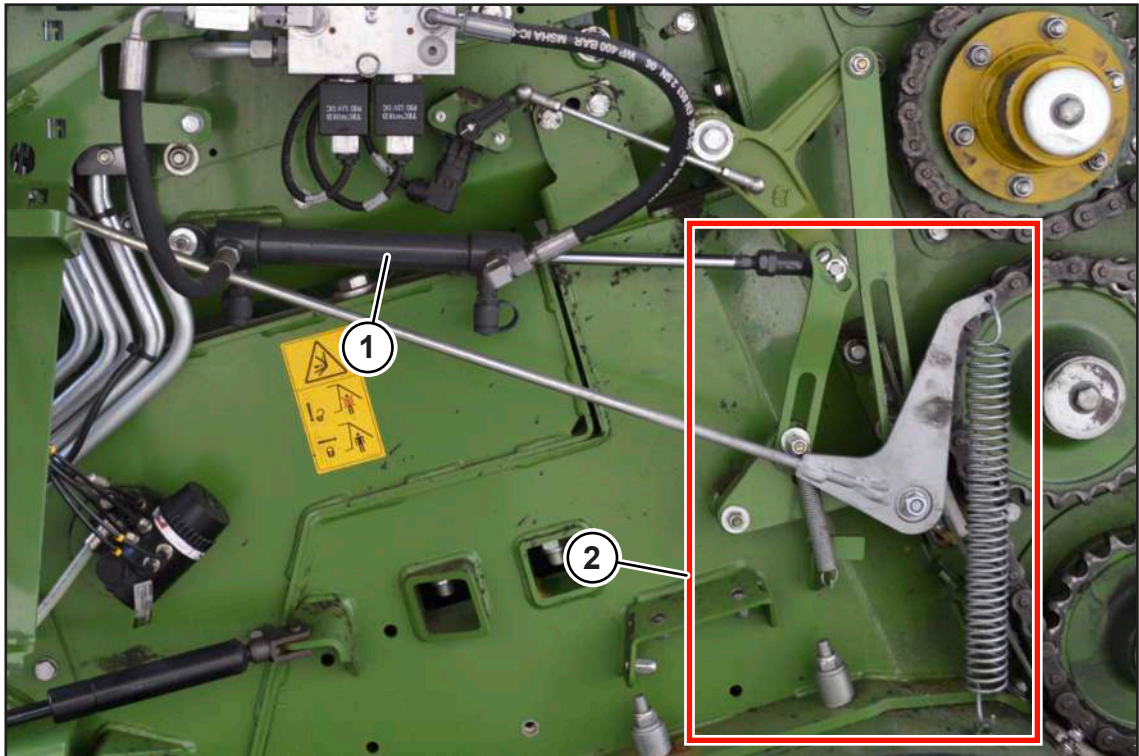

RP000-995

The cylinder (1) has been completely extended in the feed position.

- ▶ In Menu 10 "Manual operation" move the feed rocker arm into the feed position by pressing the  key.
- ▶ Check whether the cylinder (1) has been completely extended and the area (2) looks as the one illustrated.

Tying position

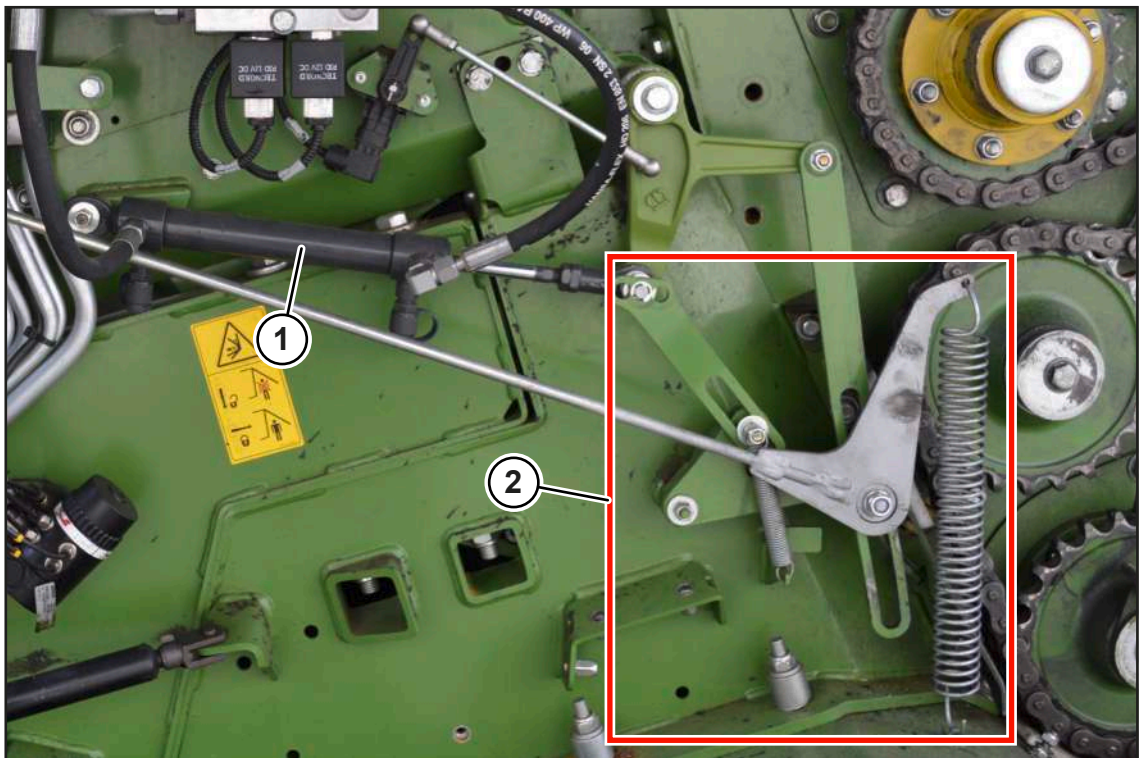

RP000-996

The cylinder (1) has been partly extended in the tying position.

- ▶ In Menu 10 "Manual operation" move the feed rocker arm into the tying position by pressing the  key.
- ▶ Check whether the cylinder (1) has been partly extended and the area (2) looks as the same as the one illustrated.

18.8 Setting the tailgate lock

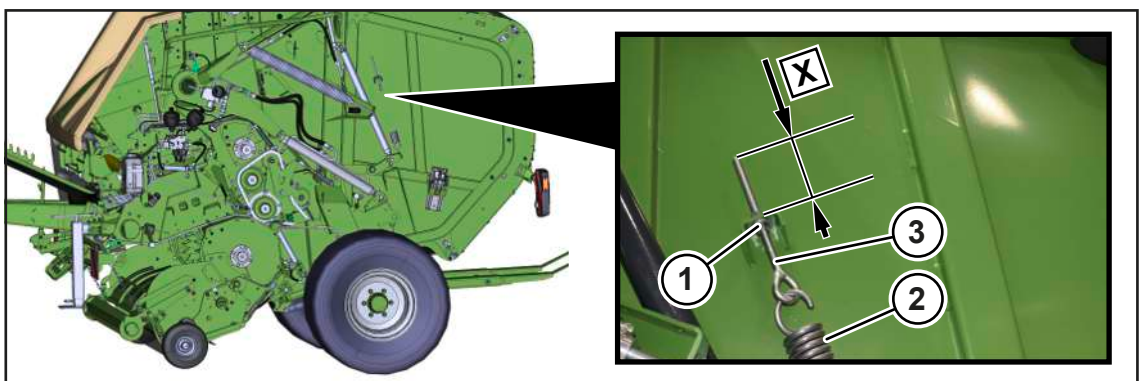

RPG000-068

If the tailgate no longer closes fully, the tailgate lock must be set on the spring (2).

Make the following setting on the right and left sides of the machine in the same way:

- ✓ The machine has been shut down and secured, [see Page 28](#).
- ▶ Check dimension X on the eyelet bolt (3).
 - ⇒ If the dimension is **X=105 mm**, the setting is correct.

⇒ If the dimension X is not **X=105 mm**, the tailgate lock must be set.

- ▶ To set the tailgate lock, release or tighten the nuts (1) until the dimension **X=105 mm**.

18.9 Checking the pressure limiting valve

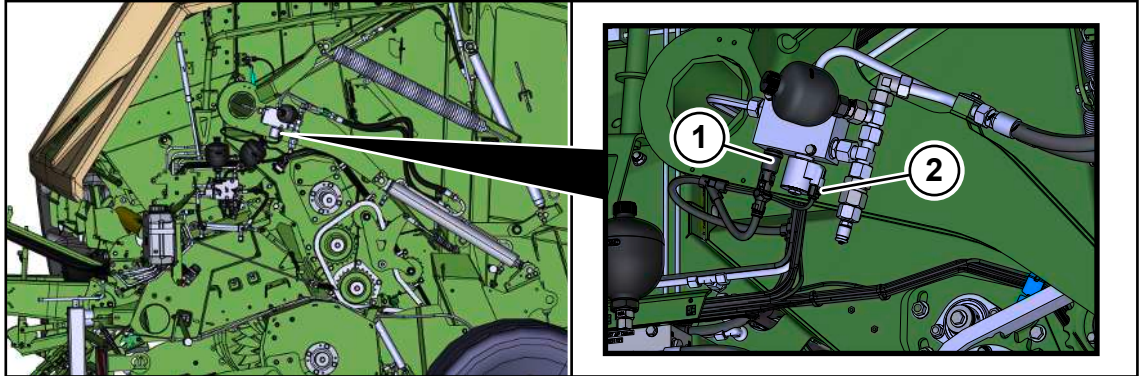

RPG000-174

The pressure limiting valve is located behind the side hood on the left side of the machine.

The light-emitting diode (2) indicates whether the pressure limiting valve of the tailgate is energised. If the pressure limiting valve is not energised, the tailgate cannot be opened.

- ▶ Check whether the light-emitting diode (2) is lit or not lit.
- ➔ If the light-emitting diode (2) is lit, the pressure limiting valve is energised.

If the light-emitting diode (2) is not lit:

- ▶ Check whether the terminal is switched on.

If the terminal is switched on and the light-emitting diode is not lit, there is an electrical fault.

- ▶ Check the machine electronics and, if required, have them repaired by the KRONE service partner.

Checking hydraulic oil pressure in the clamping system

- ✓ The tailgate is closed.
- ▶ Pull the plug (1) off the pressure limiting valve.
- ▶ Open the tailgate, [see Page 104](#).
- ➔ If the clamping cylinders extend maximum **30 mm** and the tailgate opens only approx. one quarter, the hydraulic oil pressure is correct.
- ➔ If the clamping cylinders extend more than **30 mm**, there is no hydraulic oil in the clamping system or the pressure limiting valve is defective.
- ▶ If the pressure limiting valve is defective, contact a KRONE service partner.

18.10 Filling the accumulator

After the tying mechanism has been actuated 3 times, the accumulator of the machine is empty and must be filled again.

- ▶ Close the stop cock of the tailgate, [see Page 105](#).
- ▶ Fill the accumulator from the tractor.

18.11 Cleaning deflection rolls and baling belts

If crops have accumulated between the deflection rolls, the latter must be cleaned. While cleaning the deflection rolls, manually sort the baling belts again and place them next to each other.

To do this, first bring the tensioning rockers, using a lever on the left side of the machine, into a position in which the baling belts relax, [see Page 224](#).

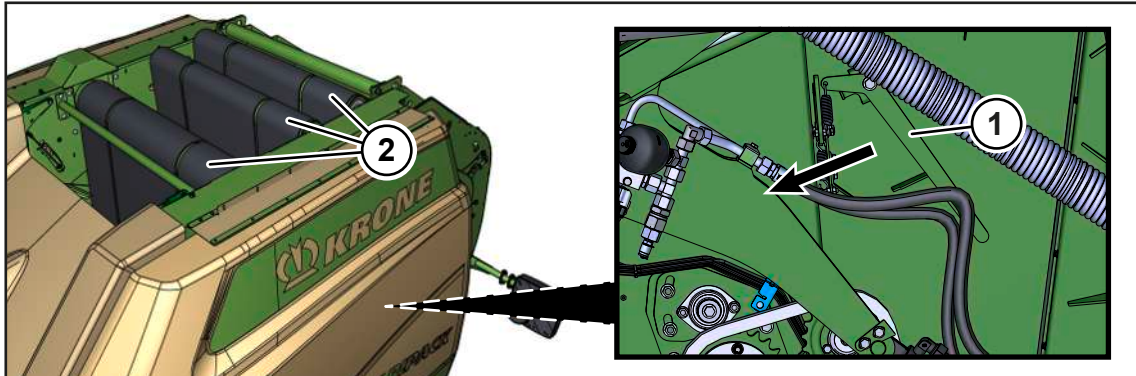

RPG000-148

- ✓ The stop cock of the tailgate is closed.
- ✓ The machine has been shut down and secured, [see Page 28](#).
- ▶ Remove crops from the deflection rolls.
- ▶ Move the baling belts (2) in the bale chamber so that all baling belts (2) are next to each other but not touching, as illustrated.
- ▶ Move the lever (1) against the direction of the arrow and push back.
- ▶ To be able to open the tailgate, open the stop cock, [see Page 105](#).
- ▶ Switch on the tractor.
- ▶ To open the tailgate fully and then to close it, actuate the control unit on the tractor (red, 1+).
 - ⇒ The baling belts are tensioned and the machine is ready for operation.

18.12 Car jack contact points

WARNING

Risk of injury due to raised machine

There is danger to persons when the machine drops or parts swing without control. Only qualified personnel are allowed to perform this work.

- ▶ Use only permitted hoists and slings with a sufficient load-bearing capacity. For the weights [see Page 50](#).
- ▶ Note the information on the suspension points provided.
- ▶ Make sure the lifting means are properly secured.
- ▶ Never stay under the suspended machine.
- ▶ If work has to be performed under the machine, securely support the machine, [see Page 29](#).

The car jack contact points are located on the left and right on the single axle or tandem axle and are marked with a sticker.

Example image of a single axle:

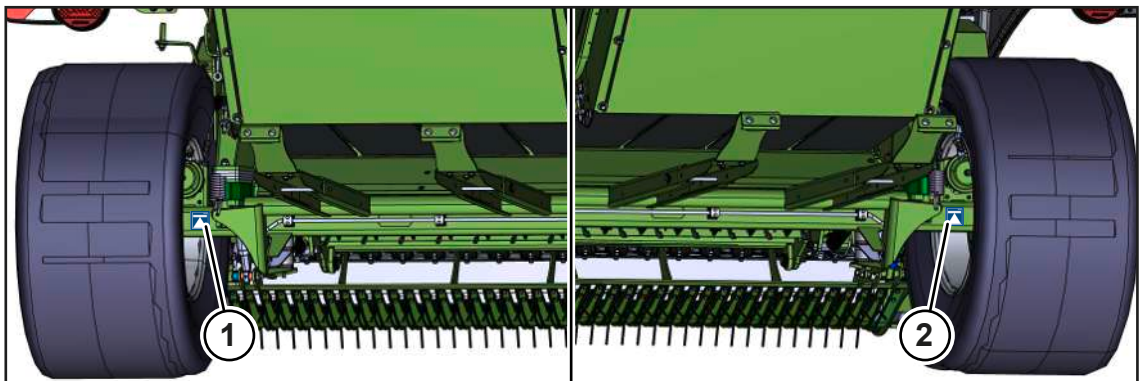

RPG000-177

1 Car jack contact point at rear left

2 Car jack contact point at rear right

19 Waste disposal

After the service life of the machine has expired, the individual components of the machine must be disposed of properly. The currently applicable country-specific waste disposal guidelines and the relevant laws must be observed.

Metal parts

- All metal parts must be taken to a metal recycling centre.
- Before scrapping, remove operating fluids and lubricants (e.g. gear oil, oil from the hydraulic system) from the components.
- The operating fluids and lubricants must be taken separately to an environmentally friendly disposal point or recycling centre.

Operating fluids and lubricants

- Operating fluids and lubricants (e.g. diesel fuel, coolant, gearbox oil, oil from hydraulic system) must be taken to a waste oil disposal point.

Synthetic materials

- All synthetic materials must be taken to a recycling centre for synthetic materials.

Rubber

- All rubber parts (e.g. hoses, tyres) must be taken to a rubber recycling centre.

Electronic components

- All electronic components must be taken to a disposal point for electronic scrap.

20 Index

A

Accessing the working screen	111, 146
Acknowledging error message	250
Activating TIM functions	150
Activating/deactivating the bearing pressure relief for the pick-up	85
Actuator test (terminal)	187
Actuator test for digital and analogue actuators	124
Additional equipment and spare parts	17
Adjust drive chains	234
Adjusting bale diameter	147
Adjusting sensor B08 "Top blade cassette"	185
Adjusting sensor B61 "Tying 1 (passive)"	186
Adjusting the drawbar height	55
Adjusting the length of the universal shaft	58
Adjusting the twine tension at the twine box	201
Adjusting the twine tension at the twine brake .	202
Airborne noise emission	50
Ambient temperature	51
Applicable documents	10
Automatic call of the Road travel screen	147
Auxiliary assignment of a joystick	152
Auxiliary functions (AUX)	151

B

B08 upper blade cassette	185
Bale dimensions	51
Baling belts have become entangled	244
Baling pressure adjustment, electronic (terminal)	163
Basic safety instructions	16
Before working on the hydraulic system	242
Behavior in the case of voltage flashover of overhead lines	24
Behaviour in dangerous situations and in case of accidents	28
Briefly deactivating cutting unit and pick-up	229
Bringing the pick-up to transport/working position	84

C

Calibrating sensors.....	123	Completing the baling process, starting tying cycle and ejecting round bales.....	79
Call road travel screen	110	Compressed air brake	
Car jack contact points	256	Drain condensation water out of the compressed-air tank	240
Carrying out oil level check and oil and filter element changes safely.....	29	Retighten tensioning straps on the compressed-air tank	241
Central chain lubrication system		Configuring TIM software (terminal)	180
Setting oil volumes on the oil pump	204	Connecting foreign ISOBUS terminal	71
Changing mode	159	Connecting hydraulic brake (export).....	62
Changing the blades	229	Connecting hydraulic hoses.....	61
Changing value	158	Connecting joystick.....	72
Checking and adjusting scraper on the feed roller	227	Connecting KRONE terminal DS 500	67
Checking and adjusting the cleaning rollers.....	225	Connecting machine to tractor.....	59
Checking and moving the blade retaining shaft	232	Connecting spools of twine with each other	100
Checking hydraulic hoses	242	Connecting the camera to the KRONE ISOBUS terminal CCI 800 or CCI 1200	75
Checking hydraulic oil pressure in the clamping system	255	Connecting the KRONE DS 100 operation unit..	66
Checking oil level, topping up oil and cleaning filter	237	Connecting the KRONE ISOBUS terminal (CCI 800, CCI 1200).....	69
Checking positions of the feed rocker arm	252	Connecting the machine	17
Checking road travel lighting	195	Connecting the road lighting	63
Checking the fire extinguisher	228	Connecting/disconnecting compressed air connections for the compressed air brake.....	62
Checking the pressure limiting valve.....	255	Consumables.....	23, 52
Checking the ratchet on the wrapping material brake	251	Contact	2
Checking the screw connections on the drawbar	224	Contamination of hydraulic system and/or fuel system	23
Checking/adjusting blades at the twine tying system	202	Conversion table.....	14
Checking/lubricating the safety rolls of the single blade locking device	234	Correction value moisture measurement (Terminal)	173
Checking/maintaining tyres	218	Counter	175
Checklist for initial operation	54	Crop blockage at the right-hand and left-hand end of the pick-up	105
Checklist for the transport of the machine.....	196	Crop blockage in the baling element	107
Children in danger	17	Crop blockage under the cutting rotor	106
Clean air filter	239	Crop collection without using guide wheels	86
Clean the bushing and the drawbar eye.....	223	Crop press roller unit	87
Cleaning deflection rolls and baling belts	256	Removing baffle sheet.....	88
Cleaning drive chains	223	Cross references	11
Cleaning the drawbar eye	223	Customer counter	175
Cleaning the machine.....	221	Cutting the net	97
Commissioning.....	59	Cutting unit.....	88
		Unlocking/locking blade retaining shaft ..	231

Cutting unit function description 49

D

Damaged compressor unit.....	26
Damaged hydraulic hoses	26
Danger associated with welding work.....	27
Danger resulting from damage to the machine... ..	18
Danger when cornering with a machine hitched and due to the overall width.....	22
Danger when driving on road and field	22
Danger zone between tractor and machine	20
Danger zone due to trailing machine parts	20
Danger zone PTO shaft	20
Danger zone universal shaft	20
Danger zone when drive is switched on	20
Danger zones	19
Dangers arising from environment.....	24
Dangers during road travel	22
Dangers if the machine is not prepared properly for road travel	22
Dangers in connection with certain activities: Working on the machine	26
Dangers in connection with certain activities: working on wheels and tyres	27
Dangers when operating the machine on slopes	23
Data memory	43
Declaration of conformity	269
Delete all errors	191
Delete individual errors	191
Design DS 500.....	130
Design of display	134
Design of the KRONE machine application	134
Diagnostics for digital actuators	189
Dimensions	50
Direction display	111, 143
Direction display sensitivity (terminal).....	164
Directories and references.....	11
Dismounting the guide wheels of the pick-up for road travel	195
Displaying the customer counter	120
Displays on the information bar	142
Displays on the working screen	140
Disturbance	
Net tears	247

The net does not reach the outside edges 248	
Disturbances at the pick-up or during picking up of crops..... 243	
Disturbances at the tying unit or during the tying cycle 246	
Disturbances during or after the baling process 244	
Drain condensation water from the compressed air tank..... 240	
Drive chain of the baling unit (no. 1)..... 235	
Drive chain of the feed roller and the starter roller (no. 3)..... 236	
Drive chain of the rotor (no. 2)..... 236	
Driving and transport 192	
DS 100	
Accessing the working screen..... 111	
Actuator test 124	
Call road travel screen mode 110	
Direction display 111	
Displaying the customer counter 120	
Number of net layers 119	
Sensor test for digital sensors 121	
Setting advance signaling 114	
Setting the bale diameter 113	
Setting the baling pressure 115	
Setting the core, centre and edge of the round bale 116	
Setting the sensitivity of direction display..... 115	
Setting the tying start delay 119	
Start tying 112	
Switching the operation unit on/off 110	
Switching the working lights on/off 113	
E	
Ejecting round bales 79	
Electronic baling pressure adjustment (terminal) 163	
Ensuring functionality of safety devices..... 21	
Environmental protection and disposal..... 24	
Error list (Terminal)..... 189	
Error message moisture measurement (Terminal) 172	
Error messages 126, 249	
F	
Faults of the electrics/electronics..... 249	
Figures..... 11	
Filling correction (terminal) 166	
Filling the accumulator 255	
Filling the bale chamber..... 77	
Fire hazard..... 23, 24	
Fitting wheel chocks 82	
Floating pick-up 86	
For "Cleaning rollers" version 225	
Foreign ISOBUS terminal 136	
Function description cutting unit 49	
Function description net wrapping 47	
Function description of twine tying..... 48	
G	
Grinding blades without blade grinding machine 233	
Grinding the blades..... 233	
H	
Hot liquids 25	
Hot surfaces..... 26	
How to use this document 11	

I

Icons in figures	12
Icons in the text	11
Identification number	46
Identification plate	45
Importance of operating instructions	16
Information for enquiries and orders	2
Information on direction	11
Information on This Document	10
Information signs on the machine	35
Initial operation	54
Inserting the net.....	96
Inserting the net roll	94
Inserting tying twine.....	101
Intended use.....	15
ISOBUS settings (terminal)	178
ISOBUS Shortcut Button (ISB).....	145

J

Jobs on the machine	18
---------------------------	----

K

Keys	138
KRONE ISOBUS terminal (CCI 800, CCI 1200)	132
KRONE operation unit DS 100	108
KRONE SmartConnect (Terminal)	179
KRONE Terminal DS 500.....	129

L

Lashing points on the machine	198
Lashing the machine.....	198
Life-threatening electric shock from overhead lines	24
Lifting the machine.....	197
Lifting/lowering blade cassette.....	88
Liquids under high pressure	25
Location and meaning of the information signs ..	36
Location and meaning of the safety signs	31
Location of the vehicle identification number	46
Locking screws on the gearboxes	217
Lower pick-up	84
Lubricating greases	53
Lubricating the universal shaft	214
Lubrication chart	210

M

Machine description	44	Malfunction, cause and remedy	243
Machine number	46	Malfunctions on the chain lubrication unit	248
Machine overview	44	Manual operation (net wrapping and twine tying), Terminal	168
Maintenance – After the season	208	Manual operation (net wrapping, terminal)	167
Maintenance – Before the season	207	Manual operation of the tying system	127
Maintenance – Every 1,000 round bales	210	Means of representation	11
Maintenance – every 10 hours, at least daily ...	209	Menu 1 "Number of twine layers" (twine tying) .	161
Maintenance – Every 2 years	210	Menu 10 "Manual operation" (for the "Net wrapping" version)	167
Maintenance – Every 250 hours	210	Menu 10 "Manual operation" (for version with "net wrapping and twine tying")	168
Maintenance – every 50 hours	209	Menu 11 "Correction of start/end position of the twine tying system (for "net wrapping and twine tying" version)	170
Maintenance – Every 500 hours	210	Menu 12 "Moisture measurement"	172
Maintenance – once after 10 hours	208	Menu 12-1 "Error message for moisture measurement"	172
Maintenance – once after 50 hours	209	Menu 12-2 "Correction value for moisture measurement"	173
Maintenance – Once after 500 round bales	209	Menu 13 "Counters"	175
Maintenance and repair work	26	Menu 13-1 "Customer counter"	175
Maintenance table	207	Menu 13-2 "Total counter"	177
Malfunction		Menu 14 "ISOBUS"	178
Baling density too low	245	Menu 14-5 "KRONE SmartConnect"	179
Central chain lubrication system: Oil consumption too high	248	Menu 14-6 "Configuring TIM software" (for "TIM 1.0" version)	180
Central chain lubrication system: Oil consumption too low	248	Menu 14-9 "Switching between terminals"	181
Central chain lubrication system: Oil pump dry	248	Menu 15 "Settings"	182
Central chain lubrication: Oil pump not completely pressed	248	Menu 15-1 "Sensor test"	183
Crop blockages	243	Menu 15-2 "Actuator test"	187
Crops are conveyed upwards by the baling belts	244	Menu 15-3 "Software info"	189
Direction display reacts too sensitively ..	245	Menu 15-4 "Error list"	189
Machine is running unevenly	245	Menu 3 "Advance signalling"	162
Net not cut cleanly	247	Menu 4 "Tying start delay"	162
Net not transported	246	Menu 6 "Electronic baling pressure adjustment"	163
Pick-up	243	Menu 8 "Select type of tying" (for the "Net wrapping and twine tying" version)	165
Round bale conical	246	Menu structure	155
Round bale does not roll out of the bale chamber	245	Menu 1 "Number of net layers" (net wrapping) .	161
Round bale is barrel-shaped, wrapping material tears	246	Menu 7 "Sensitivity of direction display"	164
Tailgate cannot be opened	246	Menu 9 "Filling correction"	166
Tailgate does not close	246	Metric thread screws with control thread	215

Metric thread screws with countersunk head and hexagon socket	216
Metric thread screws with fine thread	216
Mode of operation of TIM 1.0	148
Moisture measurement (Terminal)	172
Moisture measurement correction value (Terminal)	173
Moisture measurement error message (Terminal)	172
Mounting	83
Mounting safety chain	64
Mounting the catch loop	65
Mounting the universal shaft on the machine	57
Mounting the universal shaft on the tractor	60
Mounting universal shaft bracket	58

N

net chute	98
net motor position	
Setting sensor	186
Net wrapping	94
Layers	161
Setting rubber cloth	201
Net wrapping and tying material	51
Noise may damage your health	25
Notices with information and recommendations. 13	
Number of net layers	161
Number of twine layers (twine tying, terminal) .	161

O

Observe the service record booklet	207
Oils	53
Only perform work when the machine is at standstill	26
Open/close tailgate	104
Operating machine via joystick	151
Operating the support jack	79
Operating TIM 1.0 (Tractor Implement Management)	148
Operation	76
Operation only after proper commissioning	18
Operational safety: Technically sound condition	18
Overload protections on the machine	45
Overview	108

P

Parking the machine	193
Parking the machine safely	23
Passengers	18
Pausing TIM functions	151
Performing a visual inspection	242
Personal protective equipment	21
Personnel qualification of the operating personnel	16
Personnel qualification of the technicians	17
Pick-up	84
Setting the working height	85
Pick-up, floating	86
Position of the oil brushes	238
Possible error types (FMI)	250
Preparation before baling	76
Preparing the machine for road travel	193
Preparing the machine for shipment	196
Pre-signalling (terminal)	162

R

Raise pick-up	84
Raised machine and machine parts	27
Reasonably foreseeable misuse	15
Recurrent icons	156
Reducing the pressure on the side walls of the bale chamber	79
Releasing the baling pressure	116, 164
Releasing the cam clutch on the universal shaft	229
Releasing/applying the parking brake	81
Relieving baling belts	224
Remedying sensor/actuator error	251
Removing	83
Removing corrosion from net support / holder ..	228
Removing crop blockages	105
Removing/mounting the baffle sheet on the crop press roller unit	88
Removing/mounting the safety device which prevents unauthorised use	83
Re-ordering	10
Requirements for tractor – brake system	52
Requirements for tractor – electrics	52
Requirements for tractor - power	52
Retighten tensioning straps at the compressed air tank	241
Road safety	22
Road travel screen (automatic call-up)	147
Running actuator test	30

S

Safety	15
Safety chain	51
Safety equipment	40
Safety routines	28
Safety sign on the machine	22, 30
Scope of delivery	46, 54
Scope of the document	11
Securing raised machine and machine parts against lowering	29
Securing the front hood	197
Securing the universal shaft	194
Selecting a menu	157
Selecting a menu Level	157
Selecting type of tying (net wrapping and twine tying, terminal)	165
Selection type of tying (net wrapping and twine tying, terminal)	165
Sensitivity of direction display (Terminal)	164
Sensor test	183
Sensor test (terminal)	183
Sensor test for digital and analogue sensors ..	121
Service & maintenance	207
Service life of the machine	16
Servicing chain lubrication unit	237
Servicing compressed air brake (for version with "Compressed air brake")	239
Servicing the hydraulic system	241
Servicing the main gearbox	220
Setting advance signaling	114
Setting B61 sensor tying 1 (passive)	186
Setting net overhang on the wrapping material brake	200
Setting oil quantities for the central chain lubrication unit	204
Setting rubber cloth on the net wrapping	201
Setting the bale diameter	113, 200
Setting the bale ejector	205
Setting the baling pressure	115, 200
Setting the core, centre and edge of the round bale	116
Setting the crop press roller unit	87

Setting the cutting length	205
Setting the number of net layers	119
Setting the pick-up working height	85
Setting the sensitivity of the direction display ...	115
Setting the tailgate lock	254
Setting the tying start delay	119
Setting units on the terminal	135
Setting user preferences	128
Settings	200
Settings (terminal)	182
Shutting down and safeguarding the machine ...	28
Significance of the document	10
SmartConnect (Terminal)	179
SMV emblem	42
Software info (Terminal)	189
Sorting baling belts	256
Sources of danger on the machine	25
Start tying	112
Starting tying	79
Status line	137
Storing blades on the blade support	93
Structural modifications on the machine	17
Support jack	79
Switching between terminals	182
Switching terminal on/off	129, 133
Switching the operation unit on/off	110
Switching the working lights on/off	113
Switching warning beacon on/off	113
Swivelling blade groups in/out	91
Swivelling in/out blades	90
Swivelling the twine box to and fro	104

T

Target group of this document	10
Technical data	50
Technical limit values	19
Technically permitted maximum speed (road travel)	50
Technically sound state of the machine	18
Term "machine"	11
Terminal	
Actuator test	187
Baling pressure adjustment, electronic ...	163
Configuring TIM software	180
Correction twine tying start/end position .	170
Correction value for moisture measurement .	173
Counter	175
Direction display sensitivity	164
Error list	189
Error message for moisture measurement	172
Filling correction	166
ISOBUS settings	178
Manual operation (net wrapping and twine tying)	168
Manual operation (net wrapping)	167
Moisture measurement	172
Moisture measurement correction value	173
Moisture measurement error message ...	172
Number of net layers	161
Number of twine layers	161
Pre-signalling	162
Select menu level	157
Selecting type of tying (net wrapping and twine tying)	165
Sensor test	183
Setting units	135
Settings	182
SmartConnect	179
Software info	189
Switching between terminals	182
Twine tying start/end position	170
Tying in the menu level	160

Tying start delay	163
Terminal machine functions	137
Terminal menus.....	155
The cam clutch is released.....	244
Tightening torques.....	215
Tightening torques for "ADR/Colaert axle" version	219
Tightening torques for "BPW axle" version.....	219
TIM	
Keys on the working screen	149
Mode of operation	148
TIM displays and keys on the working screen..	149
Total counter	177
Touchable display	129, 132
Tractor requirements – hydraulics.....	52
Twine tying	100
Twine tying start/end position (terminal).....	170
Twine wrapping and tying material.....	51
Tying	
Ladders	82
Tying in the menu level	160
Tying start delay (terminal).....	163
Type plate.....	45
Tyres.....	51

U

Universal shaft.....	57
Adjusting the length of the.....	58
Unlocking/locking blade retaining shaft	231
Unsuitable consumables	23
Upper blade cassette	
Adjusting the sensor.....	185
Using ladders for the tying system	82
Using pivoted wrapping and tying material supply	98
Using the stop cock of the tailgate	105
Using the storage container for wrapping material	98

V

Validity	10
Varying functions to KRONE ISOBUS terminal	136
Vehicle identification number.....	46

W

Warning signs	12
Warnings of property damage/environmental damage.....	13
Waste disposal	258
Weights.....	50
Working at or on heights of the machine	27

Y

Your dealer's contact details.....	2
------------------------------------	---

21 Declaration of conformity**EC Declaration of Conformity**

We

KRONE Agriculture SE

Heinrich-Krone-Straße 10, D-48480 Spelle

hereby declare, as manufacturer of the product named below, under our sole responsibility, that the

Machine: Round baler**Series:** RP201-11

to which this declaration refers is in compliance with the following relevant provisions of:

- EC Directive 2006/42/EC (Machinery)
- EU Directive 2014/30/EU (EMC) The harmonised standard EN ISO 14982:2009 has been applied in accordance with the directive.

The signing Managing Director is authorised to compile the technical documents.

**Jan Horstmann**

(Managing Director, Design & Development)

Spelle, 04/08/2021

Year of manufacture:**Machine no.:**



KRONE

THE POWER OF GREEN



Maschinenfabrik

Bernard Krone GmbH & Co. KG

✉ Heinrich-Krone-Straße 10
D-48480 Spelle

✉ Postfach 11 63
D-48478 Spelle

☎ +49 (0) 59 77 / 935-0

📠 +49 (0) 59 77 / 935-339

🌐 www.landmaschinen.krone.de

