

TANK LIDS AND ACCESSORIES

TAPAS Y ACCESORIOS

Various types of lids, hinged up to 180°, threaded or bayonet lock, can be used, along with the filter baskets, with the largest range of different sizes and configuration of tanks.

The lids are made of U.V. resistant Polypropylene to offer an almost unlimited life.

Tapas de diferentes tipos, roscadas, de bayoneta o incluso rebatible a 180°, pueden aplicarse, junto a los filtros de fondo, en los tanques de las más variadas medidas y configuraciones.

Las tapas son realizadas en Polipropileno resistente a los rayos U.V. para asegurar una duración prácticamente ilimitada en el tiempo.

Symbols - Leyenda simbolos



For flat surfaces
Para superficies planas



Side connection
Fijación lateral



Twin gasket ring for flat surfaces
Para superficies planas con doble junta

HINGED TANK LIDS TAPAS REBATIBLES

Tank overturning lid 180°

Overturning lid 180° with fixing ring to the tank.

- Labyrinth breather version.
- Air valve with float version to work on sloped ground.
- Closed version.
- Available with and without blocking.
- Available with lateral fixing and for flat surfaces.
- Seal on the lid as standard.
- **Ring gasket which must be ordered separately.**
- Bayonet blocking system on six points for perfect lockup.
- 180° overturn to prevent stress on lid and tank.
- Possibility to mount the basket filter series made of plastic or steel of our production.

Tapa rebatible 180° para tanque

Tapa rebatible 180° con anillo de fijación al tanque.

- Versión con ventilación en forma de laberinto.
- Versión con válvula de aireación con flotador para trabajos en terrenos con pendientes.
- Versión cerrada.
- Disponibles con y sin bloqueo.
- Disponibles ya sea con fijación lateral o para superficies planas.
- Junta de estanqueidad de serie en la tapa.
- **Junta superior que debe ordenarse por separado.**
- Bloqueo tipo bayoneta en seis puntos para un cierre perfecto.
- Apertura 180° para evitar esfuerzos sobre la tapa y sobre el depósito.
- Posibilidad de montar la serie de filtros de cesta de plástico o de acero de nuestra producción.

Version without lockup blocking
Versión sin bloqueo de cierre



Version with lockup blocking
Versión con bloqueo de cierre



For flat surfaces
Para superficies planas

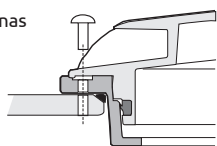

Side fixing
Fijación lateral

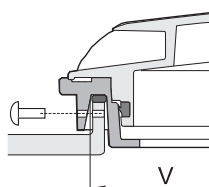

Gasket
Junta

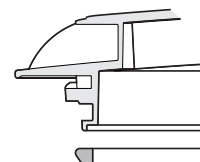

Breather with float and labyrinth

Ventilación con flotador y laberinto

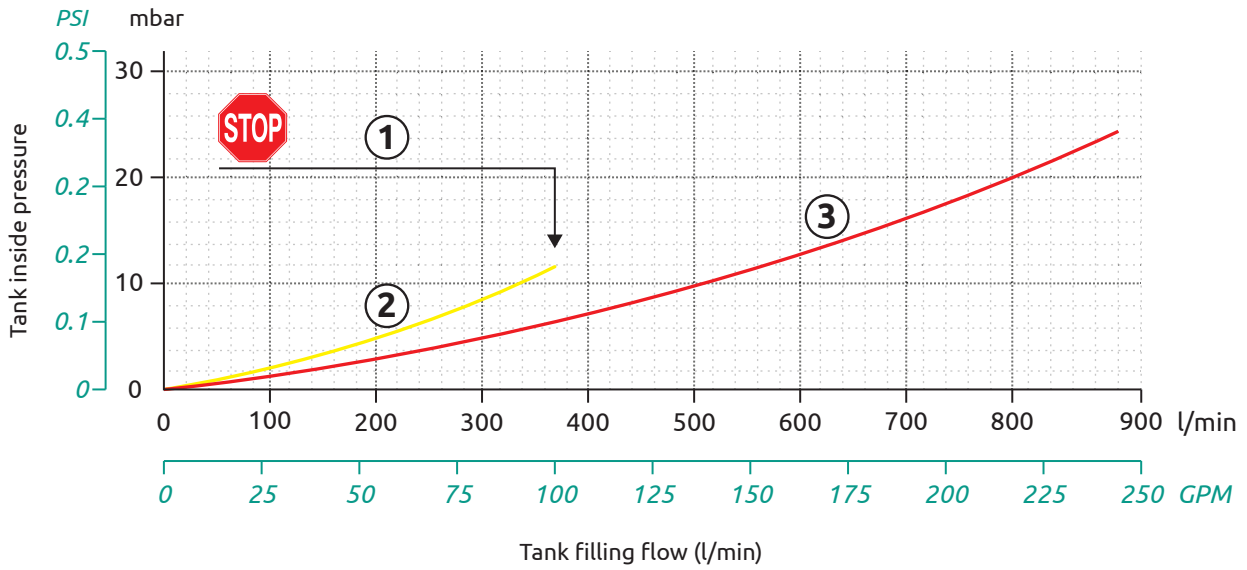

1 - Float closing
1 - Cierre flotador

2 - Float vent valve
2 - Válvula flotante

3 - Labyrinth valve
3 - Válvula de laberinto

Float vent valve

Válvula con flotante

Lockable
Con bloqueo

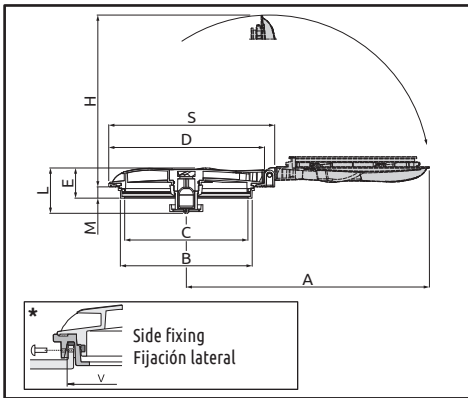

COD.		Size	D inch	B inch	C inch	E inch	M inch	H inch	S inch	A inch	V* inch	L inch				
														EPDM COD.	COD.	
356040	↓	---														
356041	↓	●	12"	14.5"	12.6"	11.4"	2.7"		16"	15.4"	22.5"	---	4"	15	350440.020	300120 300330
356045	←	---										13.2"				
356046	←	●					1"									
356060	↓	---														
356061	↓	●	16"	18.2"	16.3"	15"	3"		19.7"	19.1"	28.1"	---	4.1"	12	350460.020	300126 300130 300134
356065	←	---										16.9"				
356066	←	●														

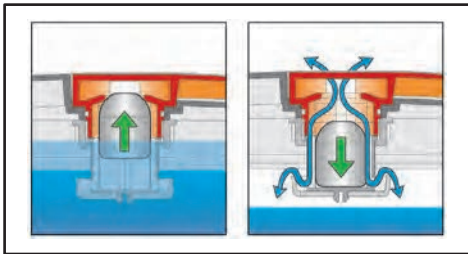

1
The cover gasket is already included in the code
La junta de la tapa ya está incluida en el código

Accessories to order separately
Accesorios a pedir por separado

Spare gasket
Junta de recambio

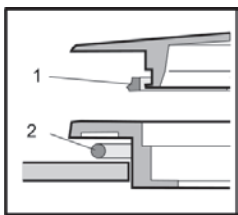

Type Tipo	COD.	for para	Material Material
1	3562040.090	Ø 12"	NBR
	3562060.090	Ø 16"	
2	350440.020	Ø 12"	EPDM
	350460.020	Ø 16"	



HINGED TANK LIDS TAPAS REBATIBLES

Labyrinth valve

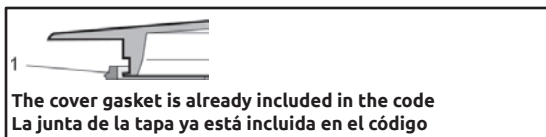
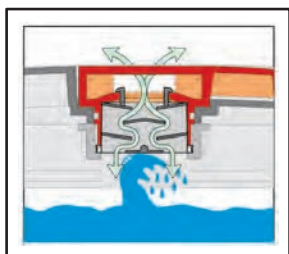
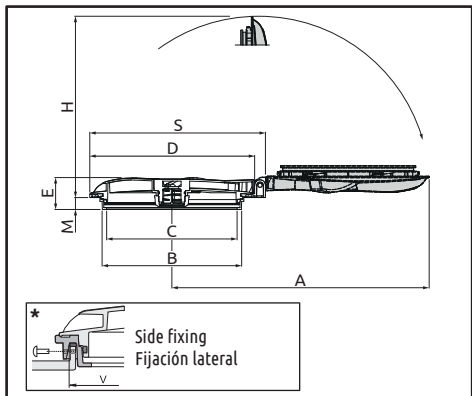
Lockable
Con bloqueo 



Válvula con laberinto

COD.		Size	D inch	B inch	C inch	E inch	M inch	H inch	S inch	A inch	V* inch		EPDM COD.		
356240	↓	---													
356241	●	12"	∅ 14.5"	∅ 12.6"	∅ 11.4"	2.7"		16"	15.4"	22.5"	---	15	350440.020	300120 300330	
356245	←	---									13.2"				
356246	●						1"								
356260	↓	---													
356261	●	16"	∅ 18.2"	∅ 16.3"	∅ 15"	3"		19.7"	19.1"	28.1"	---	12	350460.020	300126 300130 300134	
356265	←	---									16.9"				
356266	●														



Accessories to order separately
Accesorios a pedir por separado

Closed lid

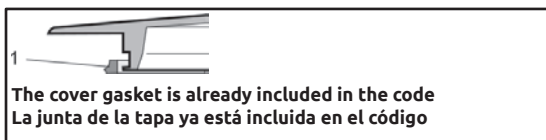
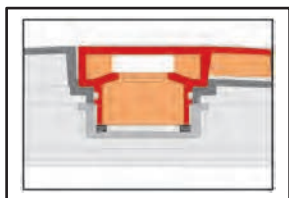
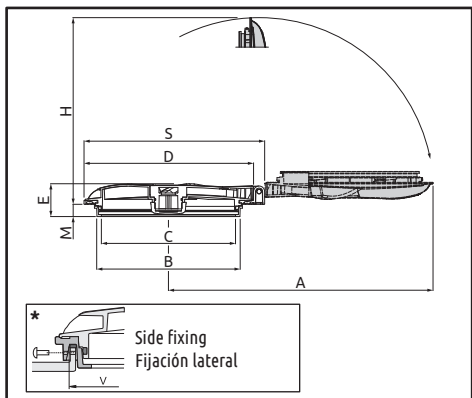
Lockable
Con bloqueo 



Tapa cerrada

COD.		Size	D inch	B inch	C inch	E inch	M inch	H inch	S inch	A inch	V* inch		EPDM COD.	
356140	↓	---												
356141	●	12"	∅ 14.5"	∅ 12.6"	∅ 11.4"	2.7"		16"	15.4"	22.5"	---	15	350440.020	300120 300330
356145	←	---									13.2"			
356146	●						1"							
356160	↓	---												
356161	●	16"	∅ 18.2"	∅ 16.3"	∅ 15"	3"		19.7"	19.1"	28.1"	---	12	350460.020	300126 300130 300134
356165	←	---									16.9"			
356166	●													

Accessories to order separately
Accesorios a pedir por separado

Spare gasket
Junta de recambio

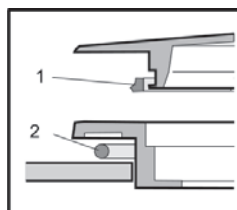

Type Tipo	COD.	for para	Material Material
1	3562040.090	∅ 12"	NBR
	3562060.090	∅ 16"	
2	350440.020	∅ 12"	EPDM
	350460.020	∅ 16"	

SMOOTH LINE 2

CLOSED LID
TAPA CERRADA

C314

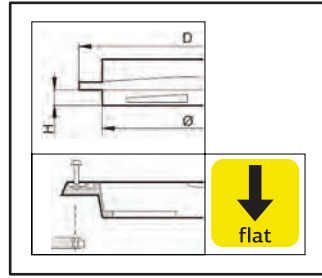

Diameter Diámetro D	Lid Tapa	Ring Aro	Ø	H	Gasket Junta	Filter Filtro
4"	3522100	350401	4.3"	0.3"	352000.020	300304

Accessories to order separately
Accesorios a pedir por separado

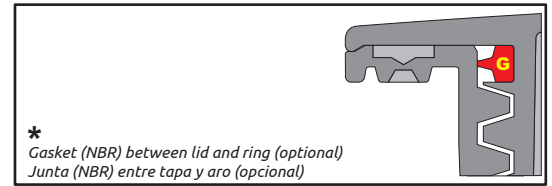
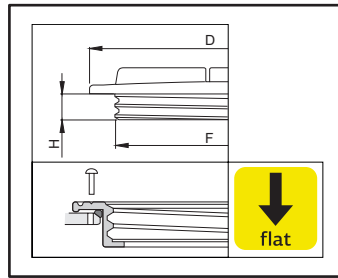

Diameter Diámetro D	Kit Lid + Ring Kit Tapa + Aro	Box	Lid Tapa		Ring Aro		F	H	Gasket* Junta*	Filter Filtro
			Box	Box	Box	Box				
8"	3510120	24	3522120	30	3502420	30	8.2"	1.2"	3522120.020	300110 300116 300315
12"	3510140	25	3522140	30	3502440	30	12.3"	1.2"	3522140.020	300120 300330
16"	3510160	18	3522160	25	3502460	23	16.1"	1"	3522160.020	300126 300130 300134
22"	3510180	20	3522180	20	350480	18	22.3"	1.2"	---	---

Accessories to order separately
Accesorios a pedir por separado

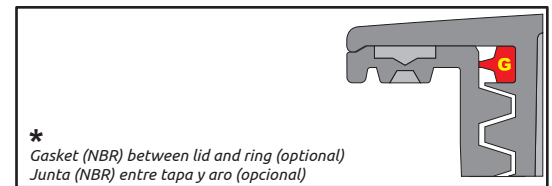
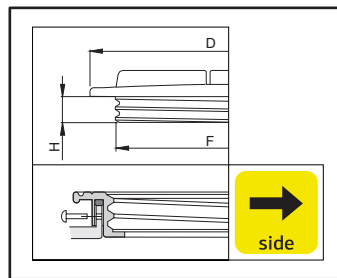

Diameter Diámetro D	Kit Lid + Ring Kit Tapa + Aro	Box	Lid Tapa		Ring Aro		F	H	Gasket* Junta*	Filter Filtro
			Box	Box	Box	Box				
8"	3516120	24	3522120	30	3502520	30	8.2"	1.2"	3522120.020	300110 300116 300315
12"	3516140	25	3522140	30	3502540	30	12.3"	1.2"	3522140.020	300120 300330
16"	3516160	18	3522160	25	3502560	23	16.1"	1"	3522160.020	300126 300130 300134

Accessories to order separately
Accesorios a pedir por separado

SMOOTH LINE 2

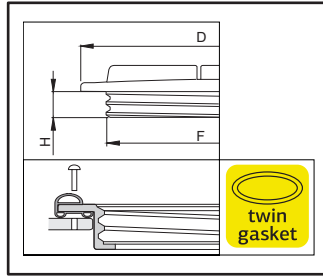

Page I-12
Página I-12

Diameter Diámetro D	Kit Lid + Ring Kit Tapa + Aro	20	Lid Tapa	30	Ring Aro	25	F	H	Filter Filtro
							inch	inch	
8"	3514120	20	3522120	30	350620	25	8.2"	1.2"	300110 300116 300315
12"	3514140	25	3522140	30	350640	28	12.3"	1.2"	300120 300330
16"	3514160	18	3522160	25	350660	23	16.1"	1"	300126 300130 300134
22"	3514180	14	3522180	20	350680	18	22.3"	1.2"	---

Accessories to order separately
Accesorios a pedir por separado

MISTRAL

GHIBLI

The vent circuit of **Mistral** and **Ghibli** has been computer designed to guarantee a large flow yet avoiding liquid out flow.

El recorrido de las válvulas a laberinto **Mistral** y **Ghibli** ha sido estudiado y optimizado para consentir un amplio paso de aire e impedir, mientras tanto, la posible salida de líquido del depósito.

MISTRAL

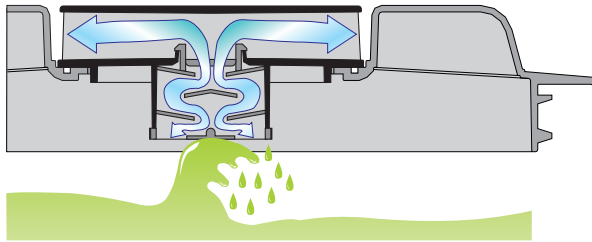

GHIBLI

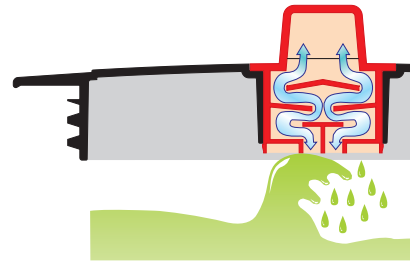

The new breather valves **Mistral** and **Ghibli** feature a great flow allowing fast tank filling with big pumps. See the flow diaphragm lines (red and blue) definitely more performant than the black line referred to our old series and to the competition's flow.

Las nuevas válvulas de laberinto **Mistral** y **Ghibli** se caracterizan por una gran capacidad de descarga del aire, para consentir un rápido llenado del depósito. En el gráfico pueden apreciarse las curvas (roja y azul) evidentemente más bajas, y por lo tanto con mejores prestaciones, respecto a la serie anterior (curva negra).

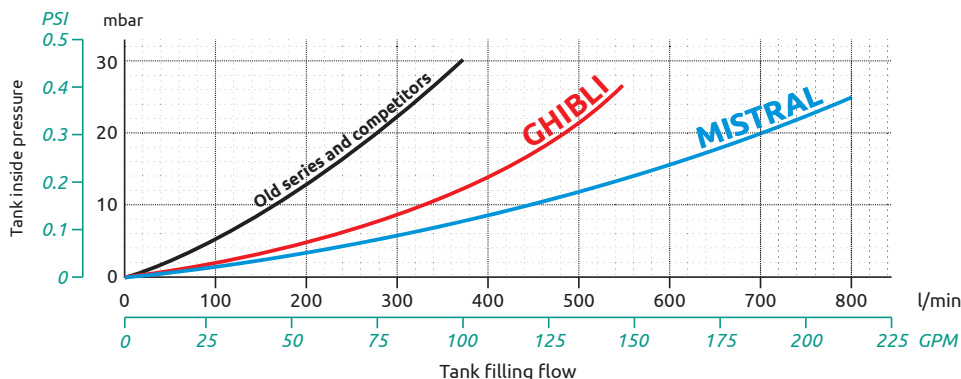

SMOOTH LINE 2

MISTRAL

"Smooth-line 2" threaded lids with removable labyrinth breather "MISTRAL"

Made to current anti-pollution standards, the lid is equipped with a double breather valve to empty the tank quickly with the lid closed, even with a high-delivery pump.

Tapas roscadas serie "Smooth-line 2" con respiradero de laberinto extraíble "MISTRAL"

Realizada según las actuales normas anticontaminación, está provista de un grupo válvula de doble respiradero que permite el vaciado rápido de la cisterna con la tapa cerrada, incluso con bombas de gran caudal.

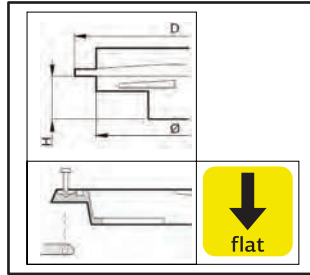

Diameter Diámetro D	Kit Lid + Ring Kit Tapa + Aro	Lid Tapa	Ring Aro	Ø	H	Gasket Junta	Filter Filtro
				inch	inch		
4"	3510000	3522000	350401	4.3"	1.3"	352000.020	300304

Accessories to order separately
Accesorios a pedir por separado

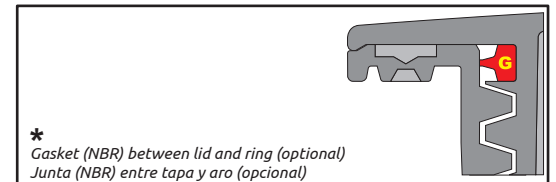
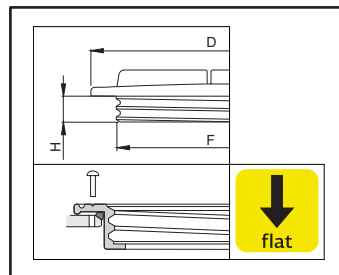

* Gasket (NBR) between lid and ring (optional)
Junta (NBR) entre tapa y aro (opcional)

Diameter Diámetro D	Kit Lid + Ring Kit Tapa + Aro		Lid Tapa		Ring Aro		F	H	Gasket* Junta*	Filter Filtro
							inch	inch		
12"	3510040	25	3522040	30	3502440	30	12.3"	1.2"	3522140.020	300120 300330
16"	3510060	18	3522060	25	3502460	23	16.1"	1"	3522160.020	300126 300130 300134
22"	3510080	15	3522080	20	350480	18	22.3"	1.2"	---	---

Accessories to order separately
Accesorios a pedir por separado

MISTRAL

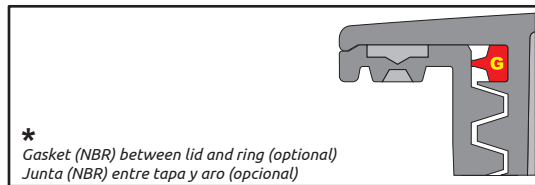
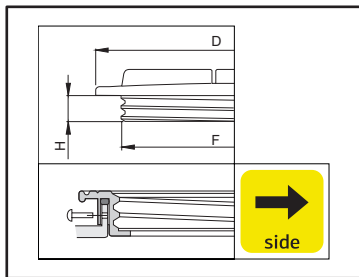

*
Gasket (NBR) between lid and ring (optional)
Junta (NBR) entre tapa y aro (opcional)

Diameter Diámetro D	Kit Lid + Ring Kit Tapa + Aro		Lid Tapa		Ring Aro		F	H	Gasket* Junta*	Filter Filtro
							inch	inch		
12"	3516040	25	3522040	30	3502540	30	12.3"	1.2"	3522140.020	300120 300330
16"	3516060	18	3522060	25	3502560	23	16.1"	1"	3522160.020	300126 300130 300134

Accessories to order separately
Accesorios a pedir por separado

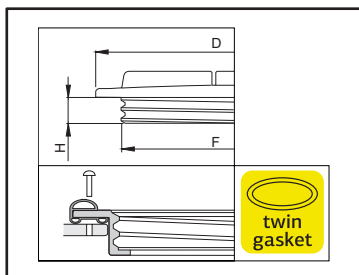

Page I-12
Página I-12

Diameter Diámetro D	Kit Lid + Ring Kit Tapa + Aro		Lid Tapa		Ring Aro		F	H	Filter Filtro
							inch	inch	
12"	3514040	24	3522040	30	350640	28	12.3"	1.2"	300120 300330
16"	3514060	18	3522060	25	350660	23	16.1"	1"	300126 300130 300134
22"	3514080	14	3522080	20	350680	18	22.3"	1.2"	---

Accessories to order separately
Accesorios a pedir por separado

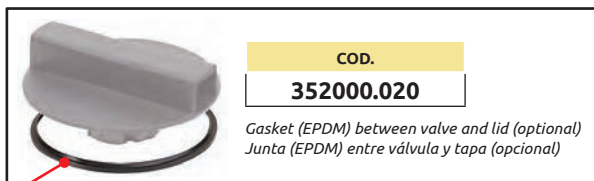

COD.

352000.020

Gasket (EPDM) between valve and lid (optional)
Junta (EPDM) entre válvula y tapa (opcional)

SMOOTH LINE 2

GHIBLI

"Smooth-line 2" threaded lids with fixed labyrinth breather "GHIBLI"

Made to current anti-pollution standards, the lid is equipped with a double breather valve to empty the tank quickly with the lid closed, even with a high-delivery pump.

Tapas roscadas serie "Smooth-line 2" con respiradero fijo de laberinto "GHIBLI"

Realizada según las actuales normas anticontaminación, está provista de un grupo válvula de doble respiradero que permite el vaciado rápido de la cisterna con la tapa cerrada, incluso con bombas de gran caudal.

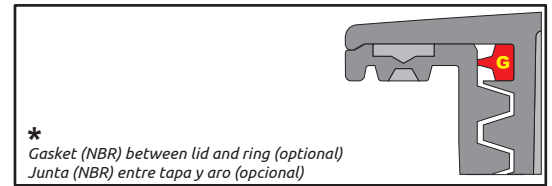
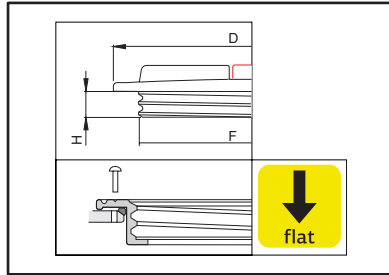

Diameter Diámetro D	Kit Lid + Ring Kit Tapa + Aro		Lid Tapa		Ring Aro		F inch	H inch	Gasket* Junta*	Filter Filtro
8"	3510221	30	3522221	28	3502420	30	8.2"	1.2"	3522120.020	300110 300116 300315
12"	3510241	25	3522241	30	3502440	30	12.3"	1.2"	3522140.020	300120 300330
16"	3510261	18	3522261	25	3502460	23	16.1"	1"	3522160.020	300126 300130 300134

Accessories to order separately
Accesorios a pedir por separado



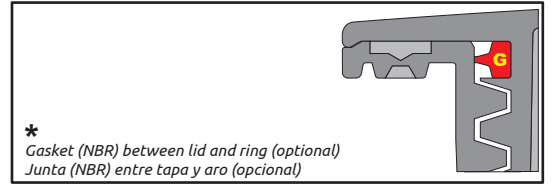
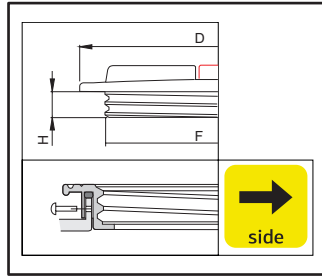

Diameter Diámetro D	Kit Lid + Ring Kit Tapa + Aro	Kit Lid + Ring Kit Tapa + Aro	Lid Tapa	Lid Tapa	Ring Aro	Ring Aro	F	H	Gasket* Junta*	Filter Filtro
									inch	inch
8"	3516221	23	3522221	28	3502520	30	8.2"	1.2"	3522120.020	300110 300116 300315
12"	3516241	25	3522241	30	3502540	30	12.3"	1.2"	3522140.020	300120 300330
16"	3516261	18	3522261	25	3502560	23	16.1"	1"	3522160.020	300126 300130 300134

Accessories to order separately
Accesorios a pedir por separado

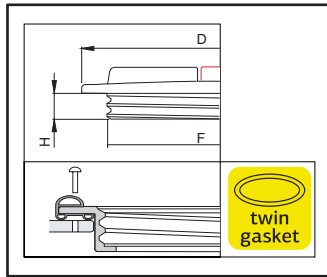

Page I-12
Página I-12

Diameter Diámetro D	Kit Lid + Ring Kit Tapa + Aro	Kit Lid + Ring Kit Tapa + Aro	Lid Tapa	Lid Tapa	Ring Aro	Ring Aro	F	H	Filter Filtro
									inch
8"	3514221	20	3522221	28	350620	25	8.2"	1.2"	300110 300116 300315
12"	3514241	22	3522241	30	350640	28	12.3"	1.2"	300120 300330
16"	3514261	18	3522261	25	350660	23	16.1"	1"	300126 300130 300134

Accessories to order separately
Accesorios a pedir por separado

Closed lid

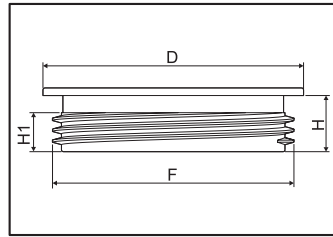

Tapa cerrada

COD.	Size	D inch	H inch	H1 inch	F inch
C00001	4"	5.4"	1.2"	0.8"	5"

LID RINGS AROS PARA TAPAS

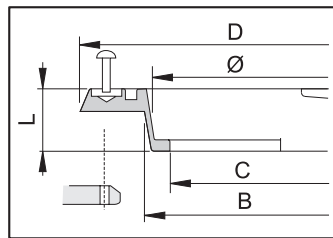

Threaded ring for flat surfaces

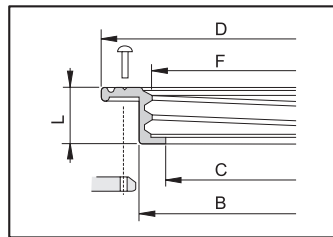

Aro roscado para superficies planas

COD.	Size	D inch	B inch	C inch	L inch	Ø inch	 COD. CÓD.
350401	4"	6.3"	4.9"	4.4"	0.7"	4.7"	300304



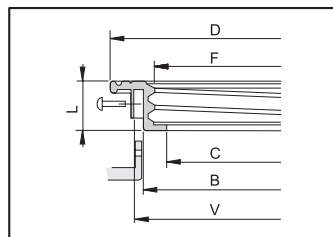

COD.	Size	D inch	B inch	C inch	L inch	F inch		 COD. CÓD.
3502420	8"	10"	8.5"	7.6"	1.5"	8.2"	30	300110
3502440	12"	14"	12.6"	11.4"		12.3"		300116
3502460	16"	18.2"	16.3"	15"	16.1"	23		300120
350480	22"	24.4"	22.6"	21.3"	1.6"	22.3"	18	---

Threaded ring with side connection



Aro roscado fijación lateral

COD.	Size	D inch	B inch	C inch	V inch	L inch	F inch		 COD. CÓD.
3502520	8"	10"	8.5"	7.6"	9.1"	1.5"	8.2"	30	300110
3502540	12"	14.2"	12.6"	11.4"	13.2"		12.3"		300116
3502560	16"	18.2"	16.3"	15"	17"	16.1"	23		300120

Sealing gaskets between tank and ring

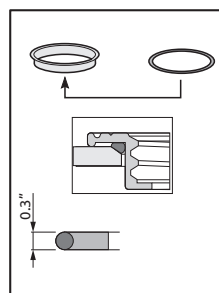

Juntas de sellado entre tanque y aro

COD.	For ring Para aros
350401.020	350401
350420.020	3502420 3502520
350440.020	3502440 3502540
350460.020	3502460 3502560
350480.020	350480

Threaded ring for flat surfaces with
double gasket

Aro roscado para superficies planas con
doble junta

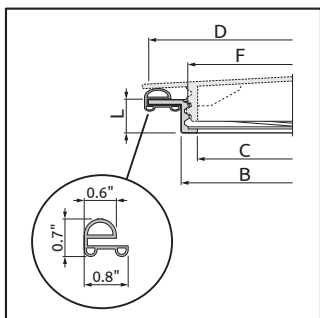

COD.	Size	D inch	B inch	C inch	L inch	F inch		 COD.
350620	8"	10"	8.5"	7.6"	1.5"	8.2"	25	300110
						12.3"		300116
350640	12"	14.2"	12.6"	11.4"		12.3"	28	300315
								300120
350660	16"	18.2"	16.3"	15"	1.4"	16.1"	23	300330
350680	22"	24.4"	22.6"	21.3"	1.6"	22.3"	18	300130

Spare parts
Repuestos

D	Gasket Junta
255 (8")	350620.020
355 (12")	350640.020
460 (16")	350660.020
620 (22")	350680.020



FEMALE THREADED TANK LIDS TAPAS DE ROSCA HEMBRA PARA CISTERNAS

Lid with labyrinth breather valve complete with gasket

Tapa con válvula de ventilación laberíntica completa con junta

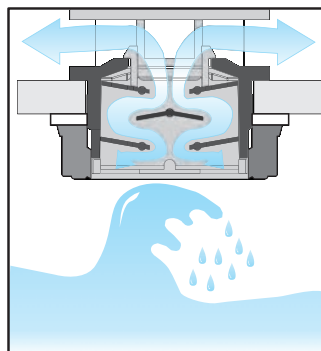
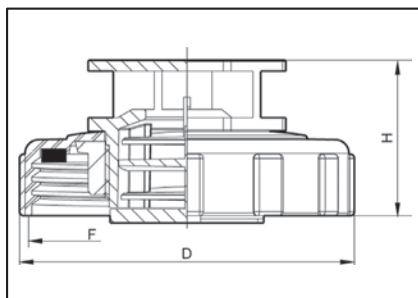

Spare gasket (NBR)
Junta de recambio (NBR)

COD.

354030.020

COD.	Size	D inch	H inch	F inch
354231	4"	4.8"	2.2"	4.5"

Lid with diaphragm breather valve complete with gasket

Tapa con membrana de respiradero completa con junta

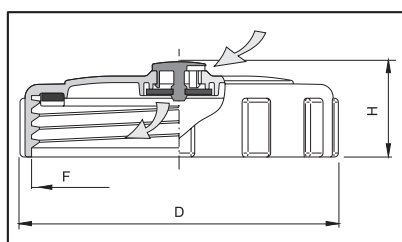

Spare gasket (NBR)
Junta de recambio (NBR)

COD.

354030.020

COD.	Size	D inch	H inch	F inch
354230	4"	4.8"	1.4"	4.5"

Closed lid complete with gasket

Tapa cerrada completa con junta

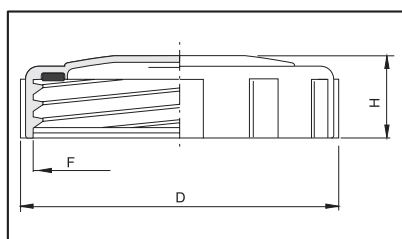

Spare gasket (NBR)
Junta de recambio (NBR)

COD.

354030.020

COD.	Size	D inch	H inch	F inch
354130	4"	4.8"	1.3"	4.5"

Transparent closed lid complete with gasket

Tapa cerrada transparente completa con junta

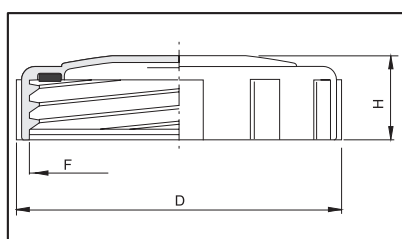

Spare gasket (NBR)
Junta de recambio (NBR)

COD.

354030.020

COD.	Size	D inch	H inch	F inch
354130T	4"	4.8"	1.3"	4.5"

SBC material

Lid with labyrinth breather valve complete with gasket

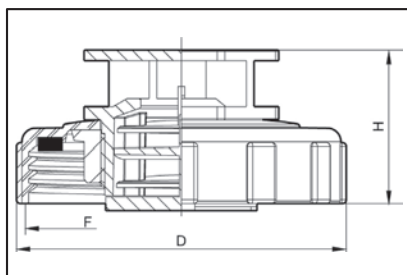

COD.	Size	D inch	H inch	F inch
3542011	6"	6.5"	2.8"	6"

Tapa con válvula de ventilación laberíntica completa con junta

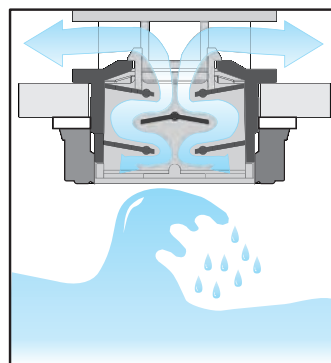

Spare gasket (NBR)
Junta de recambio (NBR)

COD.

3542010.020

Lid with spring breather and gasket

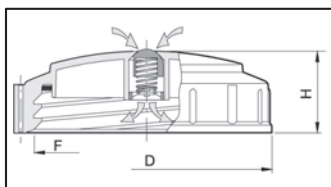

COD.	Size	D inch	H inch	F inch
3542010	6"	6.5"	1.9"	6"

Spare gasket (NBR)
Junta de recambio (NBR)

COD.

3542010.020

Closed lid with gasket

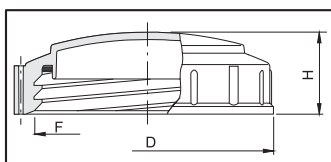

COD.	Size	D inch	H inch	F inch
3542110	6"	6.5"	1.8"	6"

Spare gasket (NBR)
Junta de recambio (NBR)

COD.

3542010.020

Tapa cerrada con junta



Lid with hole for breather valve

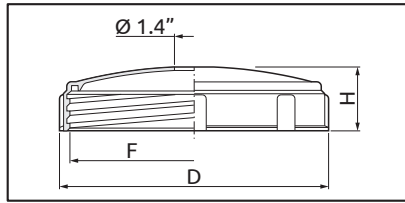

Tapa con orificio para válvula de respiradero

COD.	Size	D inch	H inch	F inch
354320	8"	9.5"	2.2"	9"

Optional gasket (EPDM)
Junta opcional (EPDM)

COD.
G11069

This lid can also be fitted with breather valves 504201 or 504203 (page I-18)
Se pueden montar las válvulas de respiradero cód. 504201 ó 504203 (pág. I-18)

Lid with diaphragm breather valve

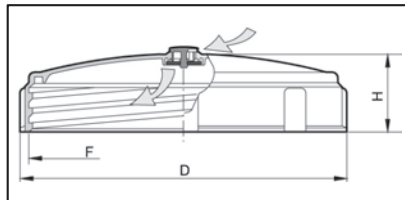

Tapa con membrana de respiradero

COD.	Size	D inch	H inch	F inch
354220	8"	9.5"	2.3"	9"

Optional gasket (EPDM)
Junta opcional (EPDM)

COD.
G11069

Closed lid

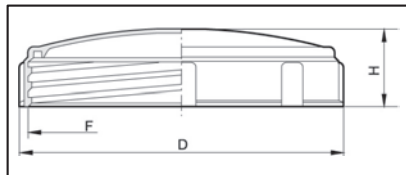

Tapa cerrada

COD.	Size	D inch	H inch	F inch
354120	8"	9.5"	2.3"	9"

Optional gasket (EPDM)
Junta opcional (EPDM)

COD.
G11069

Closed lid "DOT" with gasket

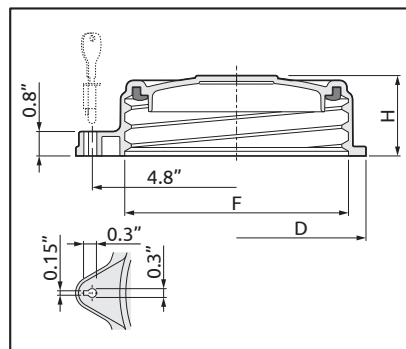

Tapa cerrada "DOT" con junta

COD.	Size	D inch	H inch	F inch
354142	7"	8.6"	2.7"	6.9"

Spare gasket (EPDM)
Junta de recambio (EPDM)

COD.
354040.020

Basket filter (screen 18 mesh)

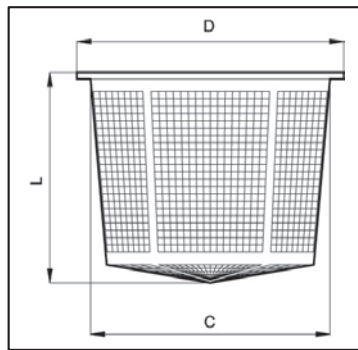

Filtros en forma de saco (18 mesh)

COD.	MESH	Size	D inch	C inch	L inch	For para	
300140	18	6"	5.5"	5"	8"	3542010 3542110	
300101	18	---	11.6"	11.2"	9.1"	---	
300110	18	8"	8"	7.4"	4.7"	3502420 3502520	
300116					9.3"		
300112	18	---	8.3"	7.4"	4.7"	---	
300118					9.3"		
300120	18	12"	11.8"	11.3"	9.6"	350640 3502440 3502540	
						356040 356041 356045 356046	
						350660 3502460 3502560	
						356060 356065	
300126	18	16"	15.7"	15"	7.3"	350660 3502460 3502560	
300130					10.8"		
300134					13"		356060 356065
300128	18	---	16.1"	7.3"	10.8"	---	
300132							10.8"
300136							13"
300119	18	---	9.1"	7.4"	9.3"	Special versions Versiones especiales	
300122	18	---	12.7"	11.3"	9.6"		
300124	18	---	13.3"				

Polypropylene basket filter

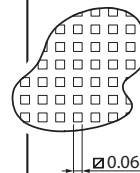
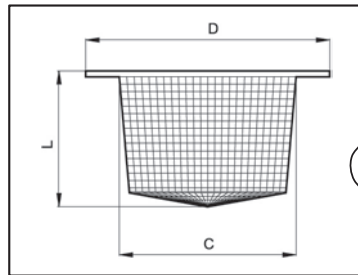

Filtro en forma de saco de polipropileno

COD.	MESH	Size	D inch	C inch	L inch
300212	12	8"	8.2"	6.4"	4.5"

Cup filter

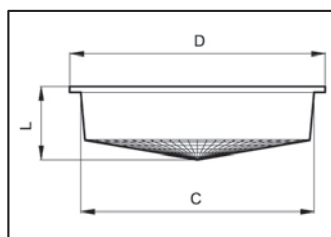

Filtro de taza

COD.	MESH	Size	D inch	C inch	L inch	for para
300309	32	---	4.1"	3.7"	1.4"	---
300304	18	4"	4.6"	4.3"	1.6"	350401
300310	18	---	7.6"	7.4"	2.4"	---
300315	18	8"	8"			3502420 3502520 350620
300320	18	---	8.2"	7.6"	1.6"	---
300330	18	12"	11.9"	11.3"	1.8"	350640 3502440 3502540
						356040 356041 356045 356046

300335	18	---	12.7"			---

Lids and filters for back-pack sprayer

Tapas y filtros para equipos de mochila

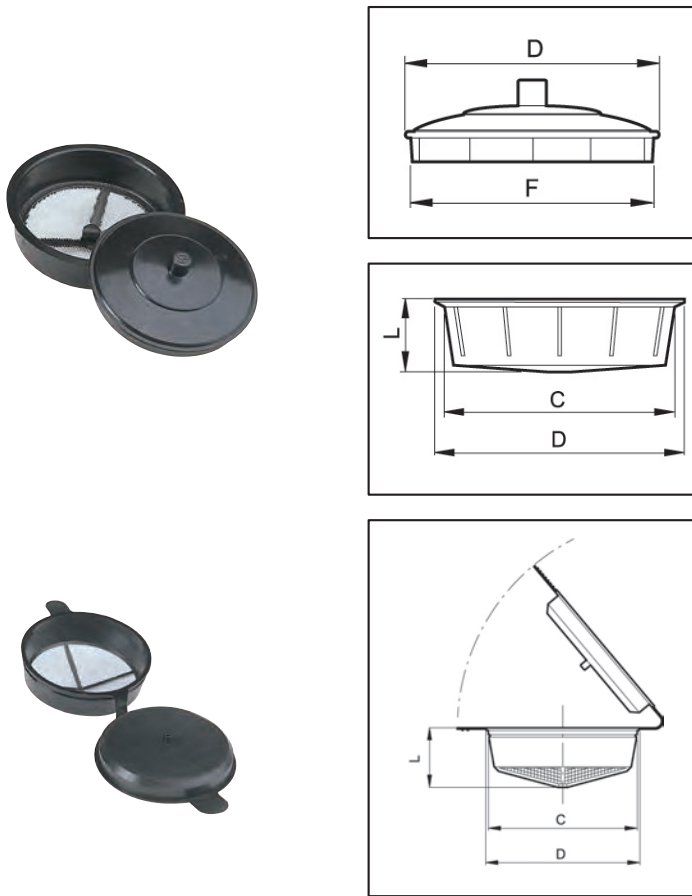

COD.	D inch	F	
		mm	inch
300303	3.5"	85	3.3"

COD.	MESH	D inch	C inch	L inch
300304	18	4.6"	4.3"	1.6"

COD.	MESH	D inch	C inch	L inch

Stainless steel AISI 304 basket filter

Filtro de cesta inox AISI 304

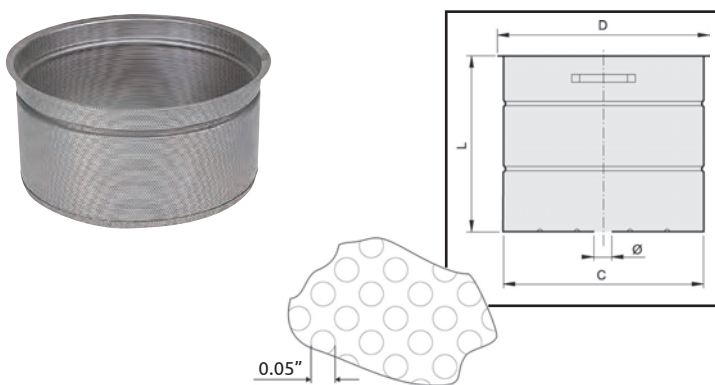

COD.	D inch	C inch	L inch	Ø	
				mm	inch
006960	15.8"	15"	13.1"	26	1"

BREATHER VALVES VÁLVULAS DE RESPIRADERO

Labyrinth breather valve

Válvula respiradero de laberinto

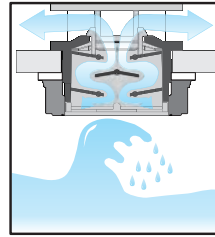
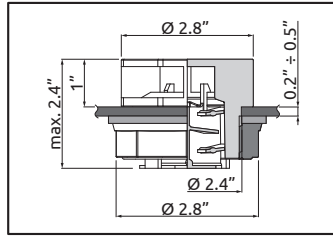

COD.
504220

Floating ball breather valve

Válvula respiradero de bola flotante

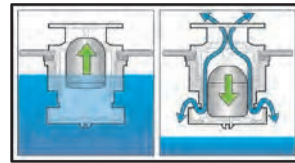
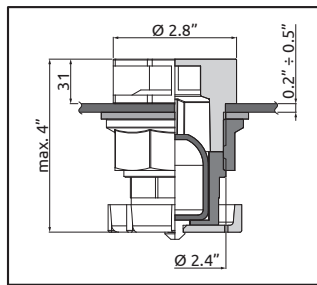

COD.
504210

PVC valve

Válvula de PVC

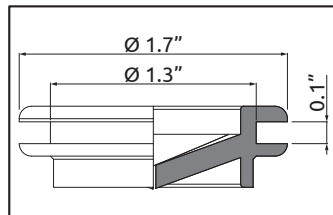

COD.
504201

Labyrinth breather valve

Válvula respiradero de laberinto

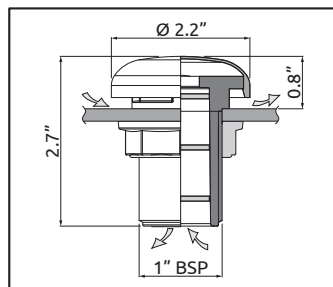

COD.
504203