

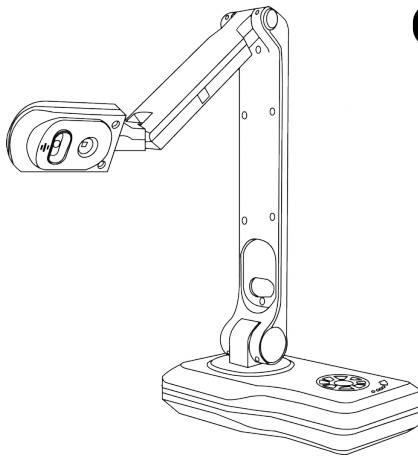

VZ0002  
**VISUALIZER PRESENTER DELUXE**  
[www.parrot.co.za](http://www.parrot.co.za)

**User Manual**



# Caution

- Use the power adapter provided
- Do not leave in direct sunlight
- Do not use in extreme humidity, dusty environments
- Carry the product by holding the base in both hands. Do not hold the product by the arm or camera head.
- Use a soft, dry cloth for cleaning. Do not use any solvent
- When the product is not in use, turn off the power
- Fold the arm when the product will not be in use

# Use

- Temperature: 0°C - 40°C (32°F - 104°F)
- Humidity: 30% - 85% (No Condensation)
- Use the product on a stable surface
- Do not turn the camera head or arm past its limitation
- Do not point the camera lense directly at the sun.
- Do not look directly into the LED light as this may cause damage to the eyes.
- Transfer all data from the SD card onto a PC and save backup information.
- Do not drop unit.
- Do not hit the camera head on any surface as this may cause damage to the lens.

# Packing List

**1.Document Camera**

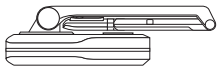

**5.Remote Controller**



**2.USB2.0 Cable**

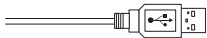

**6.CD**



**3.HDMI Cable**

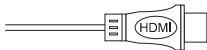

**7. VGA Cable**

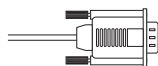

**4.DC Adapter (Output:12V1A)**

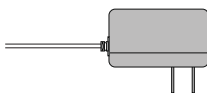

**8.User Manual**



[www.parrot.co.za](http://www.parrot.co.za)

# Product Features

- 8.0 Mega Pixel 1/4" CMOS(3264 × 2448).
- Image capture and processing, Audio & Video Recording.
- Auto Focus & 100x Digital Zoom Function.
- Flexible Camera Head with L/R 90° rotation.
- Picture-in-Picture (PIP) Mode.
- Connect directly to Projector / monitor
- 5 level dimmable LED brightness control.
- Built-in Microphone.
- Remote control included
- Annotate directly without PC software installation and save onto an SD card.
- Support touch function when connected with Touch screen.

Image roam

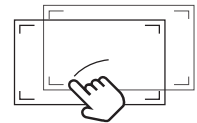
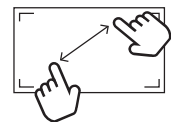
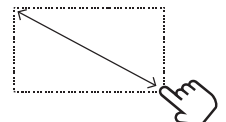

Image zoom in/out



Magnifier



# Product Preview

**Parts identification**

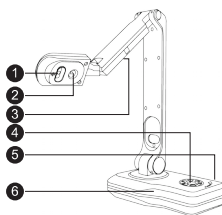

- 1-Camera Lens
- 2-LED Light
- 3-LED Lights
- 4-Control Buttons
- 5-Interface Ports
- 6-Base

**Side panel port illustration**

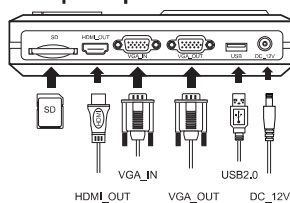

**Operating panel illustration**



- Turn on the power
- Zoom in current image
- Zoom out current image
- Function selection
- Function selection
- Turn on/off and adjust the LED lights
- Press to realize the function/auto focus
- Change the resolution/back to main menu
- Change to VGA/HDMI
- Go to the main menu

# Product Preparation

**Setting up**

1.Lift up camera arm vertically.

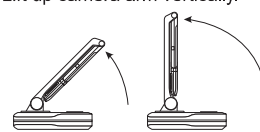

2.Rotate the arm 180° to the reverse side.

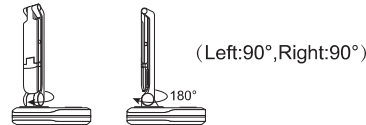

3.Lift up the camera head to be horizontal with the panel.

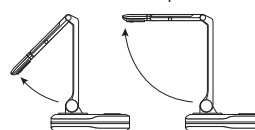

**Camera moving parts illustration**

1.Camera arm 180° rotates.

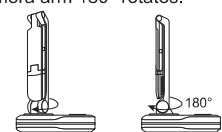

2.Camera arm 135° flips.

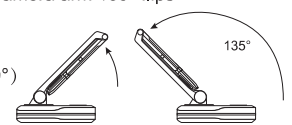

3.Camera head (Left:90°,Right:90°) rotates + 135° flips.

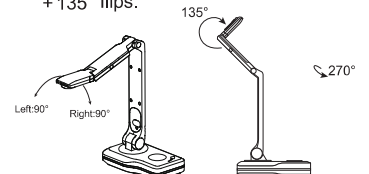

# PC Connection

- 1.Plug in the power adapter to the power socket and Document Camera.
- 2.Connect the USB cable to the PC and Document Camera.
- 3.Install the software.

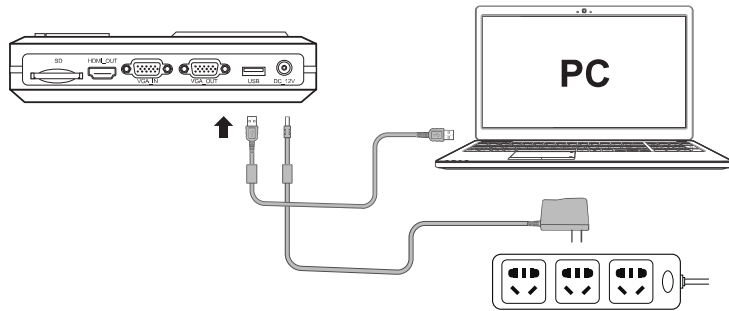

# PC-Less

- 1.Plug in the power adapter to power socket and Document Camera.
- 2.Connect the HDMI/VGA cable to the Document Camera and Touch screen.
- 3.Connect the USB cable to the Document Camera and Touch screen (touch usb port).

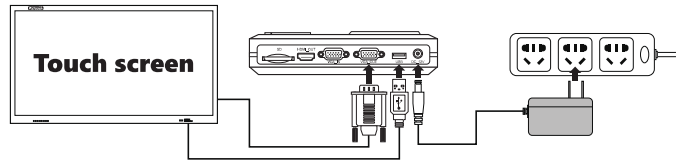

\*Calibration need to be done first for the touch function after connection.

Document Camera and external equipment connections as below:

Document Camera Interface	Connection Cable	External Equipment Interface
HDMI_OUT	HDMI	HDMI_IN
VGA_OUT	VGA	VGA_IN
VGA_IN	VGA	VGA_OUT

# Menu in HDMI/VGA Display



- Ⓐ Automatic Focusing.
- ⊕ Magnify the selected area.
- ⊕ Zoom in the image.
- ⊖ Zoom out the image.
- ↻ Rotate image by 90°/180°/270°/360°.
- ↔ Mirror the current image.
- \*\*\* Freeze the image.
- Contrast captured image with live image.
- 📷 Capture a still image.
- 📹 Record a video clip.
- 📂 Browse images and videos in SD card.
- 🖼️ Display captured images with live image on right top window.
- ✍️ Annotate on the screen and the annotation can be saved into SD card.
- ⚙️ Camera settings and other settings.

# Image Shooting & Video Record

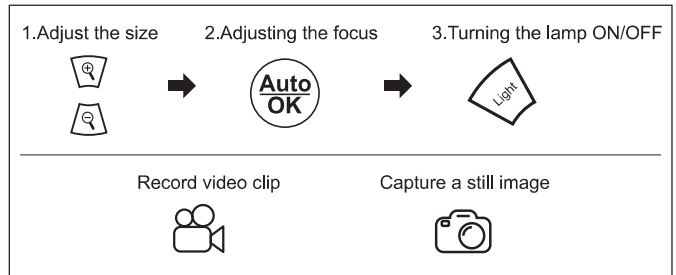

## Using the SD card

- 1.Insert the SD card into the SD card slot of the rear panel.

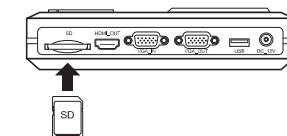

- 2.When SD card is inserted successfully, capture images will be saved automatically to SD card.

- 3.Push the SD card slightly with your finger, the SD card can be removed.

# Trouble Shooting

Problems	Possible causes	Solutions
The device does not turn on in normal condition.	The USB cable is not well connected with power.	Reconnect the USB cable.
	The power adapter is not well connected to the device or the power socket.	Make sure the power adapter is connected correctly to the device and power socket.
	The power is not turned on.	Turn on the power.
No image display after device connection.	The device is not connected to the external equipment correctly.	Re-connect the device with the external equipment.
	The external equipment is not selected correctly.	Select the correct external equipment.
	The device is not switched to the correct source of signals.	Switch to the correct source of signals.
	Equipment resolution not right.	Select the right resolution from equipment or Document Camera.
The device fails to capture images or record videos.	SD card memory is insufficient.	Remove some files and clear up the memory space of SD.
The image is blurry.	The object is too close to the camera head.	Use Auto Focus or Manual Focus to adjust the focus.
The image is too dark.	The intensity of the lighting is insufficient.	Turn on the LED light and press the light button on the operating panel to adjust the brightness.
The image does not move.	Image Freeze function is activated.	Press again the Freeze function key on the control panel or the remote control to close the function.
The remote control does not respond.	The battery runs out.	Please replace with new batteries.
	The distance between the remote control and the device is too far.	Please shorten the distance between the remote control and the device.
Touch does not respond on Touch screen.	USB cable not well connected.	Reconnect the USB cable
	No calibration process after connection.	Do the calibration

# Specifications

Pickup Device	CMOS 1/4", 8MP	
Resolution	3264*2448(8MP) 2592*1994(5MP) 1920*1080(1080p) 1280*960(SXGA) 1280*720 (720p)	
Frame Rate	15fps@1920*1080	
Zoom	100 X digital zoom	
AF/AE/AW	YES	
Shooting Size	< A3	
Color Display	Color/Black &White/Negative	
Image Processing	Contrast ratio, Brightness control, Sharpness, Saturation, Edge enhancement, Digital denoise, Freeze, Split, Picture-in-picture, Mirror, Image rotation, Annotation, USB control	
Interface Ports	USB 2.0, HDMI OUT, VGA IN,VGA OUT,SD(SD2.0, 32G)	
HDMI &VGA	2592*1994@60HZ 1280*960@60HZ 1280*720@60HZ 1920*1080@60HZ	
Photograph (Analog)	JPEG, 1080P, 5M	
Video	720P/25, 1080/5(AVI)	
Photograph (USB)	1080P, 5M	
UAC	UAC, WIN,MAC YUV 2fps@3264*2448 YUV 5fps@1920*1080P YUV 12.5fps@1280*720 YUV 15fps@800*600	YUV 2fps@2592*1994 MJPEG 15fps@1920*1080 MJPEG 15fps@1280*720 MJPEG 15fps@800*600
DC Power	EA 12V 1A	
Built-in MIC	MIC/12S Coder(12S in HDMI)	
Control Panel button	Zoom in, Zoom out, Function Selection, Auto Focus/OK, Light, Menu, VGA/HDMI, Resolution/Exit,Power	
Size	Folded: 310mm*110mm*70.5mm Open: 185mm*262.5mm*317.5mm	
Weight	1.1kg	